

Characteristics

C_N	1x 149 μ F \pm 5 %	
U_N	AC 400 V	
f_N	50 Hz	60 Hz
Q_N	7,5 kvar	9 kvar
I_N	1x 19 A	23 A
$\tan \delta_0$	0,2 W/kvar (dielectric)	

Maximum ratings

U_{max}	AC 440 V, 8 h daily AC 520 V, 1 min
$I_r(40)$	1x 35 A ($\Theta_A = 40^\circ\text{C}$, U_N)
I_s	5200 A
$(du/dt)_{max}$	14 V/ μ s
$(du/dt)_s$	35 V/ μ s

Test data

U_{TT}	AC 900 V, 10 s
U_{TC}	AC 3000 V, 10 s
$\tan \delta$ (50 Hz)	$\leq 0,5$ W/kvar (total)

Climatic category -40/D

Θ_{min}	-40 °C
Θ_{max}	+55 °C
Humidity	Max. relative Humidity ≤ 95 %
Θ_{stg}	-55 bis +70 °C

Life expectancy

t_{LD}	100 000 h
----------	-----------

Remarks

Natural cooling

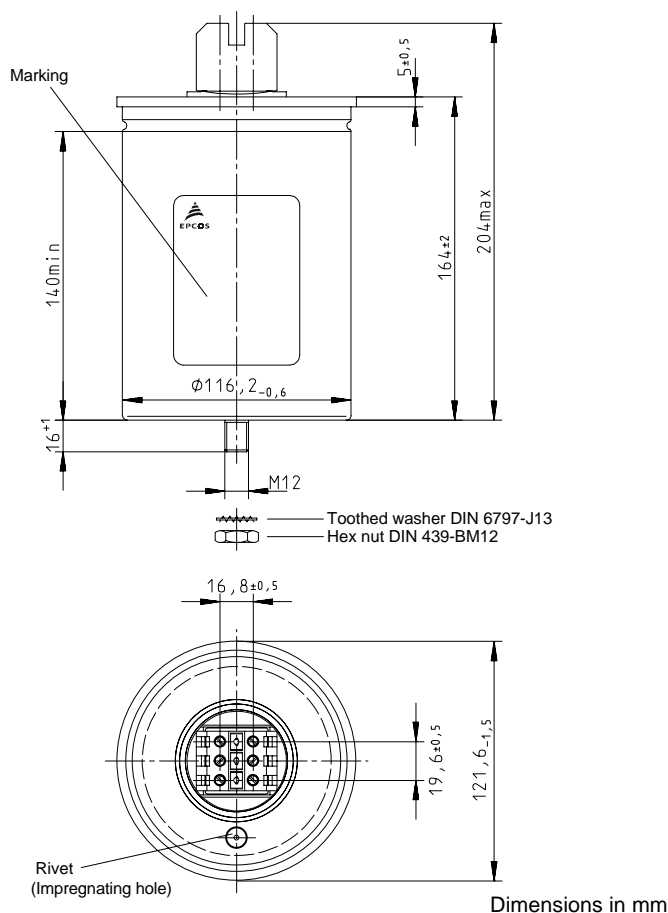

Design data

Dimensions \varnothing x l	121,6 x 164 mm (4,79 x 6,46 in)
Approx. weight	1,1 kg (2,4 lb)
Impregnation	Gas
Fixing	Threaded bolt M12
Mounting hole	14 mm (0,55 in)
Max. torque	10 Nm
Terminals	Isolated terminal, IP20
Max. torque	1,2 Nm
Terminal cross section	16 mm ² (5 AWG)
Creepage distance	12,7 mm (0,50 in)
Clearance	9,6 mm (0,38 in)
Overpressure disconnecter	
Any mounting position possible	