



150mA Low-Dropout Linear Regulators

Features

- Low, 55 μ A No-Load Supply Current
- Guaranteed 150mA Output Current
- Dropout Voltage is 70mV @ 50mA Load
- Over-Temperature Protection and Short-Circuit Protection
- Two Modes of Operation ----
Fixed Mode: 2.84V (G913A), 3.15V (G913B),
3.30V (G913C), 3.00V (G913D)
Adjustable Mode: from 1.25V to 5.5V
- Max. Supply Current in Shutdown Mode < 1 μ A
- Low Output Noise at 220 μ V_{RMS}
- Stability with lost cost ceramic capacitors

Applications

- Notebook Computers
- Cellular Phones
- PDAs
- Digital still Camera and Video Recorders
- Hand-Held Devices
- Bar Code Scanners

General Description

The G913 is a low supply current, low dropout linear regulator that comes in a space saving SOT23-5 package. The supply current at no-load is 55 μ A. In the shutdown mode, the maximum supply current is less than 1 μ A. Operating voltage range of the G913 is from 2.5V to 5.5V. The over-current protection limit is set at 250mA typical and 150mA minimum. An overtemperature protection circuit is built-in in the G913 to prevent thermal overload. These power saving features make the G913 ideal for use in the battery-powered applications such as notebook computers, cellular phones, and PDA's.

The G913 has two modes of operation. When the SET pin is connected to ground, its output is a pre-set value: 2.84V for G913A, 3.15V for G913B, and 3.30V for G913C, and 3.00V for G913D. There is no external components needed to decide the output voltage. When an output other than the preset value is needed, two external resistors should be used as a voltage divider. The output voltage is then decided by the resistor ratio. The G913 comes in a space saving SOT23-5 package.

Ordering Information

PART	MARKING	VOLTAGE	TEMP. RANGE	PIN-PACKAGE
G913A	3A	2.84	-40°C~ +85°C	SOT 23-5
G913B	3B	3.15	-40°C~ +85°C	SOT 23-5
G913C	3C	3.30	-40°C~ +85°C	SOT 23-5
G913D	3D	3.00	-40°C~ +85°C	SOT 23-5

Pin Configuration

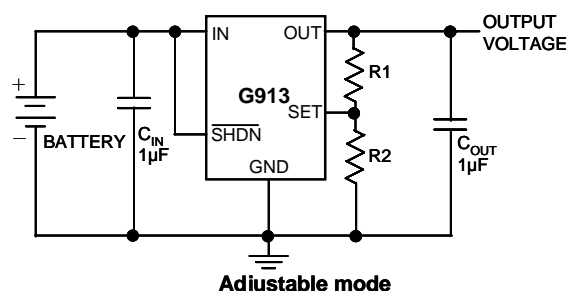
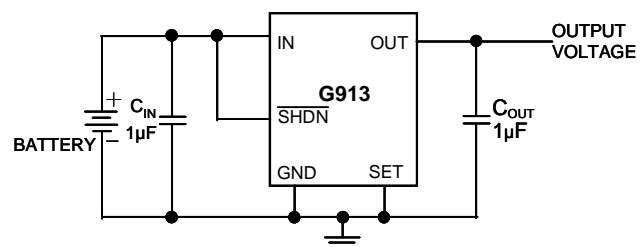
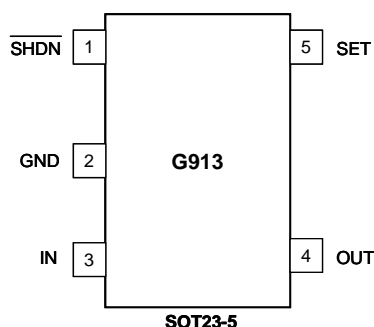

Absolute Maximum Ratings

V_{IN} to GND.....	-0.3V to +7V
Output Short-Circuit Duration.....	Infinite
SET to GND.....	-0.3V to +7V
\overline{SHDN} to GND.....	-0.3V to +7V
\overline{SHDN} to IN.....	-7V to +0.3V
OUT to GND.....	-0.3V to ($V_{IN} + 0.3V$)

Continuous Power Dissipation ($T_A = +25^\circ\text{C}$)	SOT23-5.....	520 mW
Operating Temperature Range.....	-40°C to +85°C	
Junction Temperature.....	+150°C	
$\theta_{JA}^{(1)}$	240°C/Watt	
Storage Temperature Range.....	-65°C to +160°C	
Lead Temperature (soldering, 10sec).....	+300°C	

Note (1): See Recommended Minimum Footprint (Figure 3)

Stresses beyond those listed under "Absolute Maximum Ratings" may cause permanent damage to the device. These are stress ratings only, and functional operation of the device at these or any other conditions beyond those indicated in the operational sections of the specifications is not implied. Exposure to absolute maximum rating conditions for extended periods may affect device reliability.

Electrical Characteristics

($V_{IN} = +3.6V$, $V_{\overline{SHDN}} = V_{IN}$, $T_A = T_J = +25^\circ\text{C}$, unless otherwise noted.) (Note 1)

PARAMETER	SYMBOL	CONDITIONS		MIN	TYP	MAX	UNITS
Input Voltage (Note 2)	V_{IN}			2.5		5.5	V
Output Voltage Accuracy	V_{OUT}	Variation from specified V_{OUT} , $I_{OUT} = 1\text{mA}$		-2		2	%
Adjustable Output Voltage Range (Note 3)	V_{OUT}			V_{SET}		5.5	V
Maximum Output Current				150			mA
Current Limit (Note 4)	I_{LIM}				250		mA
Ground Pin Current	I_Q	SET = GND	$I_{LOAD} = 0\text{mA}$		55	120	μA
			$I_{LOAD} = 50\text{mA}$		145		
Dropout Voltage (Note 5)	V_{DROPO}	$I_{OUT} = 1\text{mA}$			2		mV
		$I_{OUT} = 50\text{mA}$			70		
		$I_{OUT} = 150\text{mA}$			230	300	
Line Regulation	ΔV_{LNR}	SET=GND, $V_{IN} = V_{(STD)} + 0.1V$, to 5.5V $I_{OUT} = 1\text{mA}$			0.1	0.28	%V
		SET tied to OUT, $V_{IN} = 2.5V$ to 5.5V, $I_{OUT} = 1\text{mA}$			0.08	0.4	
Load Regulation	ΔV_{LDR}	$I_{OUT} = 0\text{mA}$ to 150mA	SET tied to OUT		0.02	0.8	%
			SET = GND			1.0	
Output Voltage Noise (10Hz to 100kHz)	e_n	$V_{IN} = 4.2V$, $I_{OUT} = 150\text{mA}$	$C_{OUT} = 1\mu\text{F}$		220		μV_{RMS}
SHUTDOWN							
SHDN Input Threshold	V_{IH}	Regulator enabled		$V_{IN} - 0.7$			V
		Regulator shutdown				0.4	
SHDN Input Bias Current	$I_{\overline{SHDN}}$	$V_{\overline{SHDN}} = V_{IN}$	$T_A = +25^\circ\text{C}$		0.003	0.1	μA
Shutdown Supply Current	I_{QSHDN}	$V_{OUT} = 0V$	$T_A = +25^\circ\text{C}$		0.2	1	μA
SET INPUT							
SET Reference Voltage (Note 3)	V_{SET}	$V_{IN} = 2.5V$ to 5.5V, $I_{OUT} = 1\text{mA}$	$T_A = +25^\circ\text{C}$	1.225	1.25	1.275	V
			$T_A = T_{MIN}$ to T_{MAX}		1.25		
SET Input Leakage Current (Note 3)	I_{SET}	$V_{SET} = 1.3V$	$T_A = +25^\circ\text{C}$		5	30	nA
THERMAL PROTECTION							
Thermal Shutdown Temperature	T_{SHDN}				150		$^\circ\text{C}$
Thermal Shutdown Hysteresis	ΔT_{SHDN}				15		$^\circ\text{C}$

Note 1: Limits is 100% production tested at $T_A = +25^\circ\text{C}$. Low duty pulse techniques are used during test to maintain junction temperature as close to ambient as possible.

Note 2: Guaranteed by line regulation test.

Note 3: Adjustable mode only.

Note 4: Not tested. For design purposes, the current limit should be considered 150mA minimum to 420mA maximum.

Note 5: The dropout voltage is defined as ($V_{IN} - V_{OUT}$) when V_{OUT} is 100mV below the value of V_{OUT} for $V_{IN} = V_{OUT} + 2V$, The performance of every G913 part, see "Typical Performance Characteristics".

Typical Performance Characteristics

($V_{IN} = +3.6V$, $C_{IN} = 1\mu F$, $C_{OUT} = 1\mu F$, G913B, $T_A = 25^\circ C$, unless otherwise noted.)

Output Voltage vs. Load Current

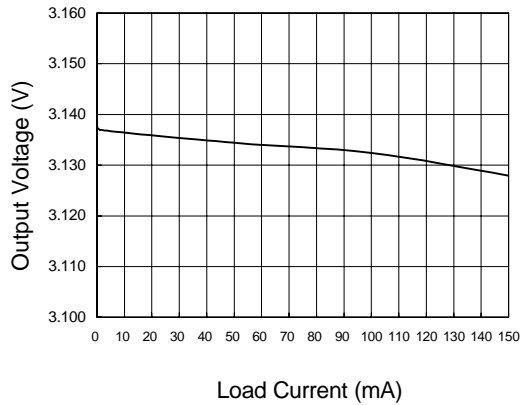

Ground Current vs. Load Current

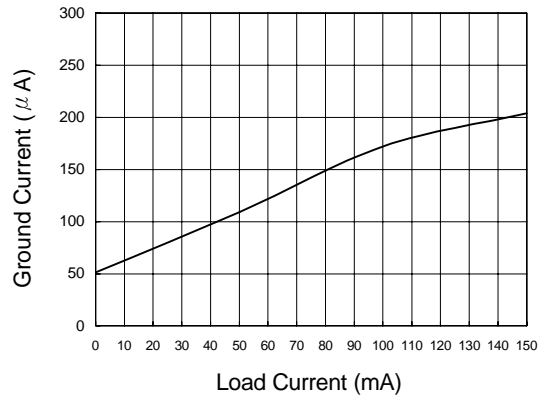

Output Voltage vs. Load Current

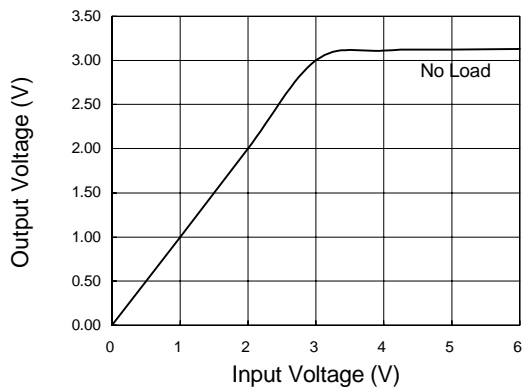

Supply Current vs. Input Voltage

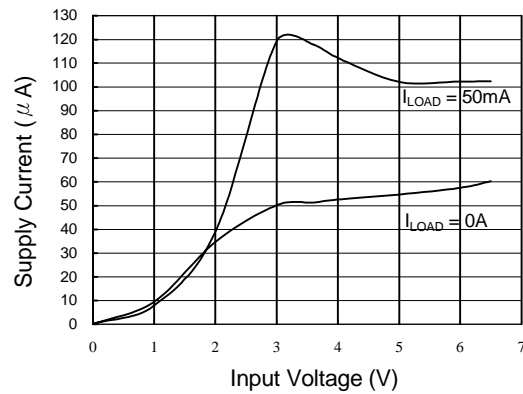

Dropout Voltage vs. Load Current

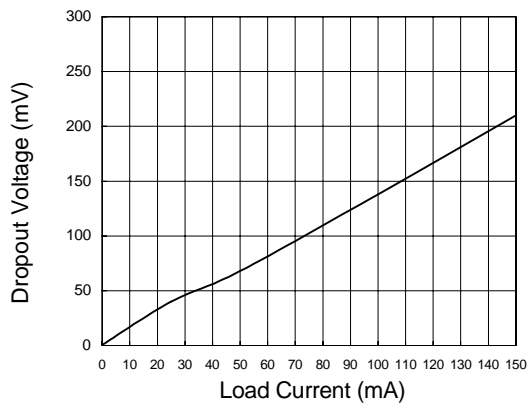

Output Noise 10HZ to 100KHZ

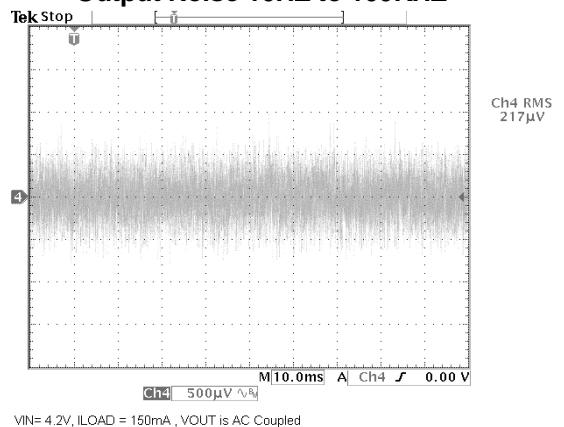

Typical Performance Characteristics

($V_{IN} = +3.6V$, $C_{IN} = 1\mu F$, $C_{OUT} = 1\mu F$, G913B, $T_A = 25^\circ C$, unless otherwise noted.)

Line Transient

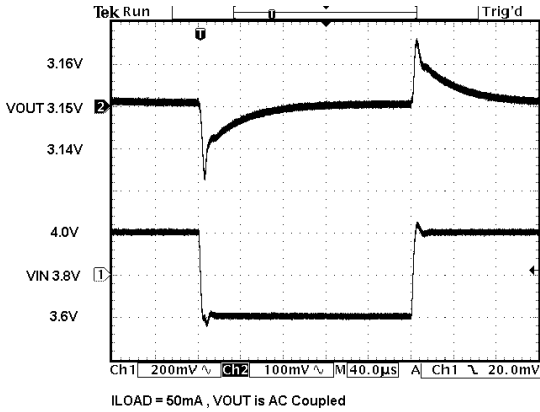

Load Transient

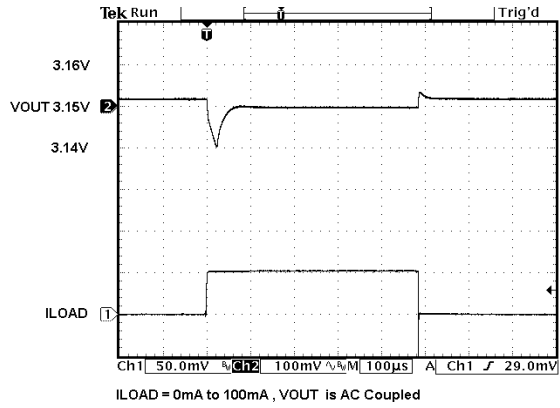

Load Transient

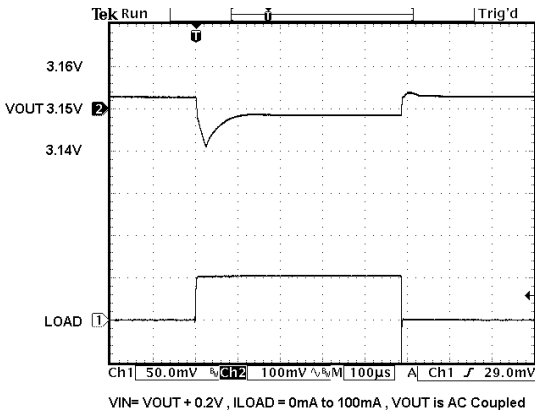

Load Transient

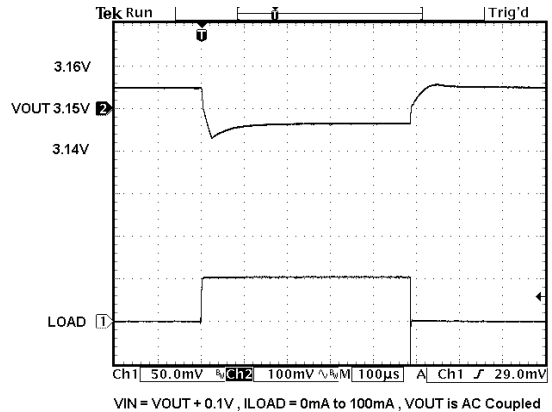

Dropout Voltage vs. Load Current by G913

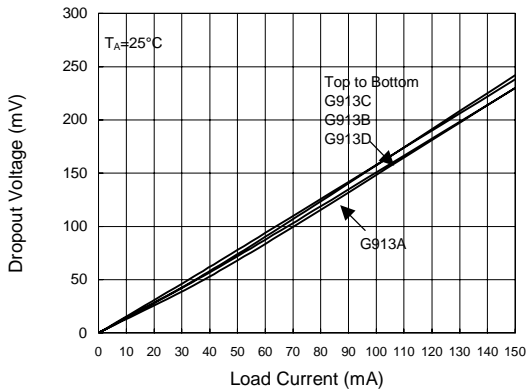

Dropout Voltage vs. Temperature

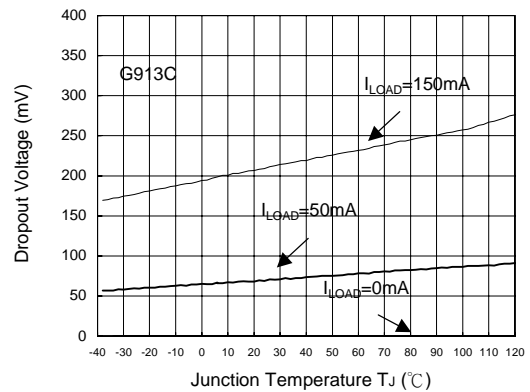

Typical Performance Characteristics

($V_{IN} = +3.6V$, $C_{IN} = 1\mu F$, $C_{OUT} = 1\mu F$, G913B, $T_A = 25^\circ C$, unless otherwise noted.)

Turn on Response Time

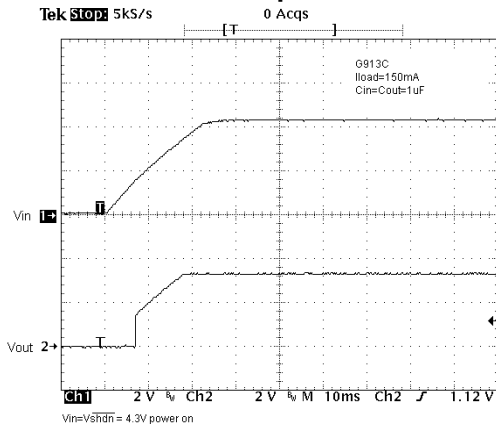

Turn off Response Time

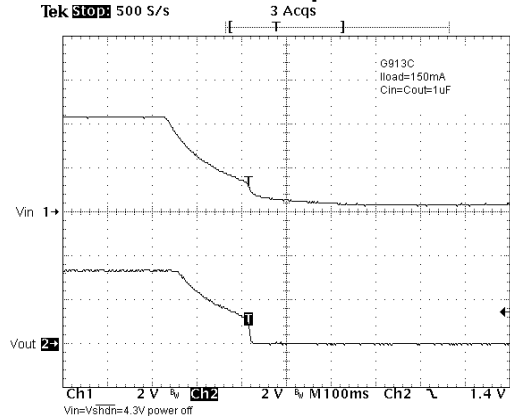

Shutdown Pin Delay

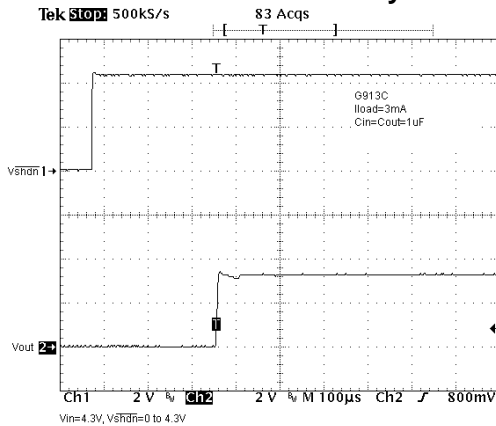

Shutdown Response Time

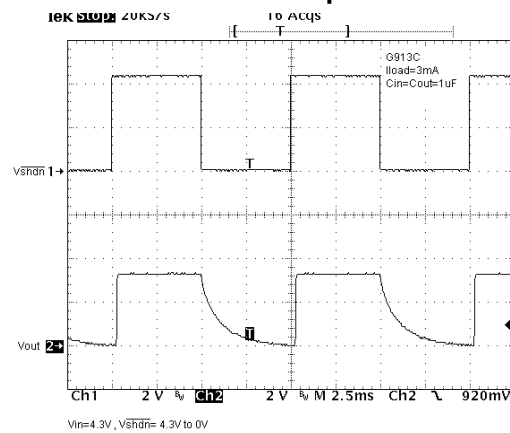

Shutdown Pin Delay

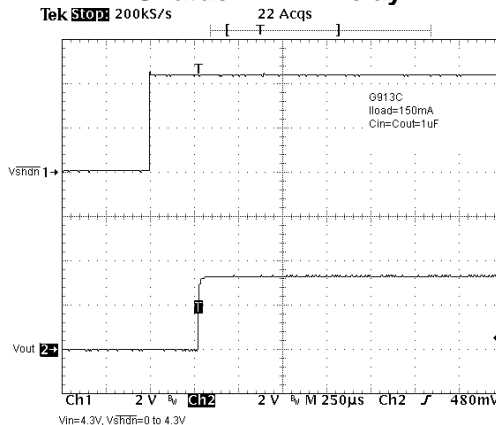

Shutdown Response Time

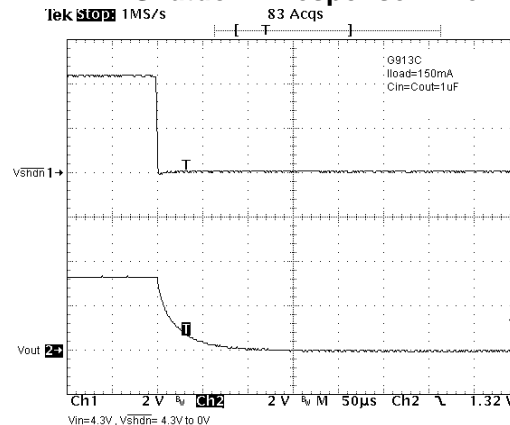

Typical Performance Characteristics

($V_{IN} = +3.6V$, $C_{IN} = 1\mu F$, $C_{OUT} = 1\mu F$, G913B, $T_A = 25^\circ C$, unless otherwise noted.)

Shutdown Supply Current

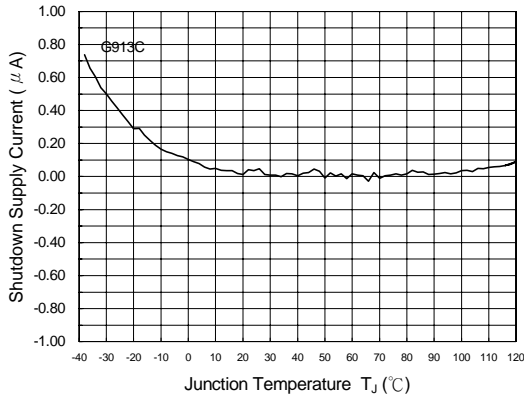

\overline{SHDN} Input Bias Current vs. Temperature

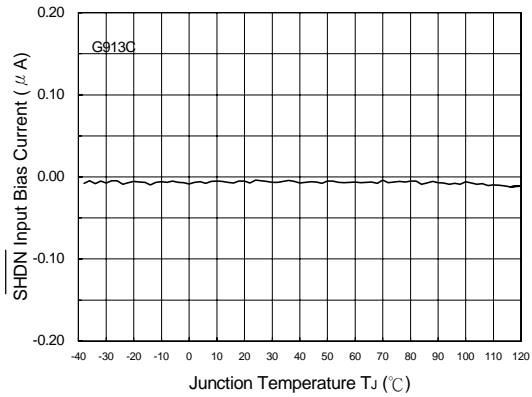

SET Input Leakage Current vs. Temperature

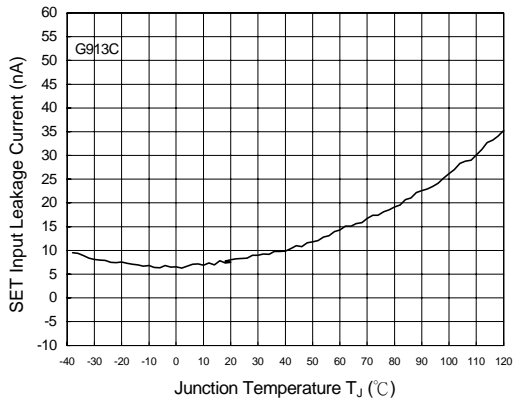

SET Reference Voltage vs. Temperature

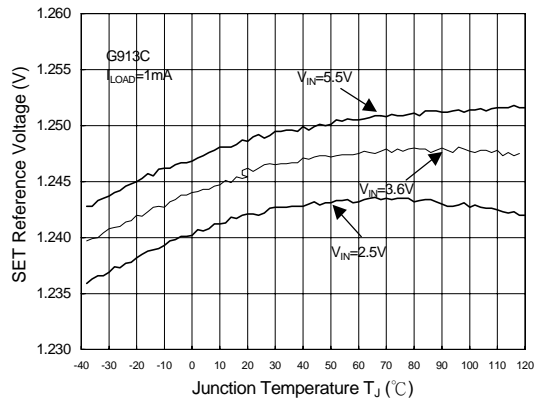

Output Voltage vs. Temperature

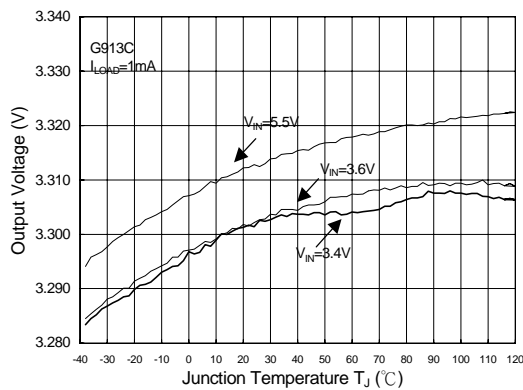

Ground Current vs. Temperature

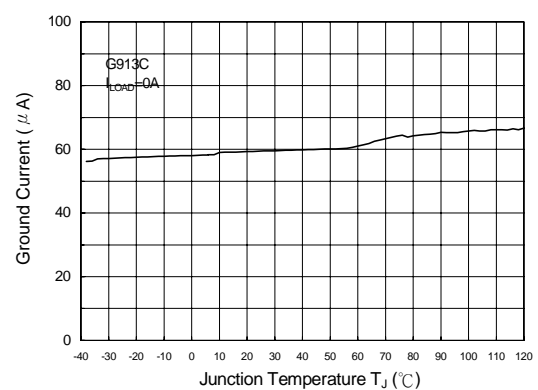

Pin Description

PIN	NAME	FUNCTION
1	$\overline{\text{SHDN}}$	Active-Low Shutdown Input. A logic low reduces the supply current to less than 1 μ A. Connect to IN for normal operation.
2	GND	Ground. This pin also functions as a heatsink. Solder to large pads or the circuit board ground plane to maximize thermal dissipation.
3	IN	Regulator Input. Supply voltage can range from +2.5V to +5.5V. Bypass with 1 μ F to GND
4	OUT	Regulator Output. Fixed or adjustable from 1.25V to +5.5V. Sources up to 150mA. Bypass with a 1 μ F, < 0.2 Ω typical ESR capacitor to GND.
5	SET	Feedback Input for Setting the Output Voltage. Connect to GND to set the output voltage to the preset 2.84V or 3.15V or 3.30V or 3.00V. Connect to an external resistor divider for adjustable-output operation.

Detailed Description

The block diagram of the G913 is shown in Figure 1. It consists of an error amplifier, 1.25V bandgap reference, PMOS output transistor, internal feedback voltage divider, mode comparator, shutdown logic, over current protection circuit, and over temperature protection circuit.

The mode comparator compares the SET pin voltage with an internal 120mV reference. If the SET pin voltage is less than 120mV, the internal feedback voltage divider's central tap is connected to the non-inverting input of the error amplifier. The error amplifier compares non-inverting input with the 1.25V bandgap reference. If the feedback voltage is higher than 1.25V, the error amplifier's output becomes higher so that the PMOS output transistor has a smaller gate-to-source voltage (V_{GS}). This reduces the current carrying capability of the PMOS output transistor, as a result the output voltage decreases until the feedback voltage is equal to 1.25V. Similarly, when the feedback voltage is less than 1.25V, the error amplifier causes the output PMOS to conductor more current to pull the feedback voltage up to 1.25V. Thus, through this feedback

action, the error amplifier, output PMOS, and the voltage divider effectively form a unity-gain amplifier with the feedback voltage force to be the same as the 1.25V bandgap reference. The output voltage, V_{OUT} , is then given by the following equation:

$$V_{OUT} = 1.25 (1 + R1/R2). \quad (1)$$

Alternatively, the relationship between R1 and R2 is given by:

$$R1 = R2 (V_{OUT} / 1.25 + 1). \quad (2)$$

For the reasons of reducing power dissipation and loop stability, R2 is chosen to be 100K Ω . For G913A, R1 is 128K Ω , and the pre-set V_{OUT} is 2.84V. For G913B, R1 is 152K Ω , and the pre-set V_{OUT} is 3.15V. For G913C, R1 is 164K Ω , and the pre-set V_{OUT} is 3.30V. For G913D, R1 is 140K Ω , and the pre-set V_{OUT} is 3.00V.

When external voltage divider is used, as shown in Figure 2, the SET pin voltage will be larger than 600mV. The non-inverting input of the amplifier will be connected to the external voltage divider. However, the operation of the feedback loop is the same, so that the conditions of Equations 1 and 2 are still true. The output voltage is still given by Equation 1.

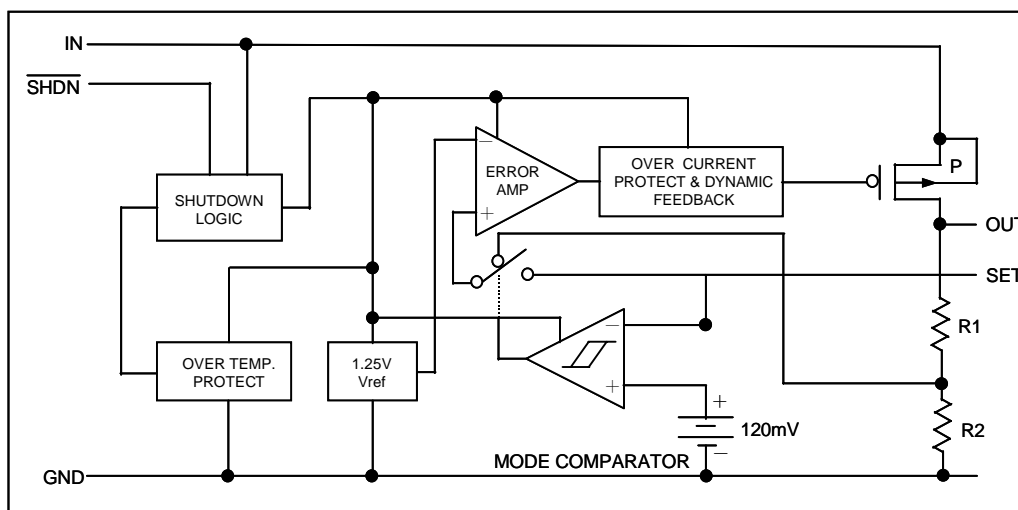

Figure 1. Functional Diagram

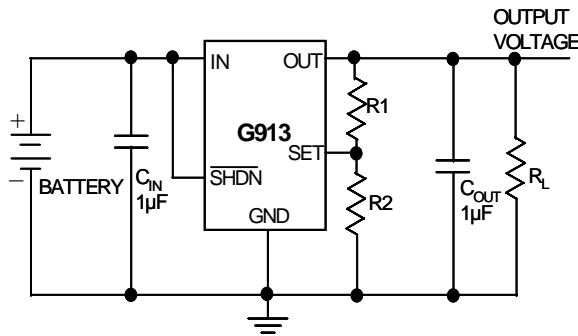

Figure 2. Adjustable Output Using External Feedback Resistors

Over Current Protection

The G913 use a current mirror to monitor the output current. A small portion of the PMOS output transistor’s current is mirrored onto a resistor such that the voltage across this resistor is proportional to the output current. This voltage is compared against the 1.25V reference. Once the output current exceeds the limit, the PMOS output transistor is turned off. Once the output transistor is turned off, the current monitoring voltage decreases to zero, and the output PMOS is turned on again. If the over current condition persist, the over current protection circuit will be triggered again. Thus, when the output is shorted to ground, the output current will be alternating between 0 and the over current limit. The typical over current limit of the G913 is set to 250mA. Note that the input bypass capacitor of 1µF must be used in this case to filter out the input voltage spike caused by the surge current due to the inductive effect of the package pin and the printed circuit board’s routing wire. Otherwise, the actual voltage at the IN pin may exceed the absolute maximum rating.

Over Temperature Protection

To prevent abnormal temperature from occurring, the G913 has a built-in temperature monitoring circuit. When it detects the temperature is above 150°C, the output transistor is turned off. When the IC is cooled down to below 135°C, the output is turned on again. In this way, the G913 will be protected against abnormal junction temperature during operation.

Shutdown Mode

When the SHDN pin is connected a logic low voltage, the G913 enters shutdown mode. All the analog circuits are turned off completely, which reduces the current consumption to only the leakage current. The output is disconnected from the input. When the output has no load at all, the output voltage will be discharged to ground through the internal resistor voltage divider.

Operating Region and Power Dissipation

Since the G913 is a linear regulator, its power dissipation is always given by $P = I_{OUT} (V_{IN} - V_{OUT})$. The maximum power dissipation is given by:

$$P_{D(MAX)} = (T_J - T_A) / \theta_{JA} = 150^\circ\text{C} - 25^\circ\text{C} / 240^\circ\text{C/W} = 520\text{mW}$$

Where $(T_J - T_A)$ is the temperature difference the G913 die and the ambient air, θ_{JA} , is the thermal resistance of the chosen package to the ambient air. For surface mount device, heat sinking is accomplished by using the heat spreading capabilities of the PC board and its copper traces. In the case of a SOT23-5 package, the thermal resistance is typically 240°C/Watt. (See Recommended Minimum Footprint) [Figure 3] Refer to Figure 4 is the G913 valid operating region (Safe Operating Area) & refer to Figure 5 is maximum power dissipation of SOT 23-5.

The die attachment area of the G913’s lead frame is connected to pin 2, which is the GND pin. Therefore, the GND pin of G913 can carry away the heat of the G913 die very effectively. To improve the power dissipation, connect the GND pin to ground using a large ground plane near the GND pin.

Applications Information

Capacitor Selection and Regulator Stability

Normally, use a 1µF capacitor on the input and a 1µF capacitor on the output of the G913. Larger input capacitor values and lower ESR provide better supply-noise rejection and transient response. A higher- value input capacitor (10µF) may be necessary if large, fast transients are anticipated and the device is located several inches from the power source.

Power-Supply Rejection and Operation from Sources Other than Batteries

The G913 is designed to deliver low dropout voltages and low quiescent currents in battery powered systems. Power-supply rejection is 42dB at low frequencies. As the frequency increases above 20kHz, the output capacitor is the major contributor to the rejection of power-supply noise.

When operating from sources other than batteries, improve supply-noise rejection and transient response by increasing the values of the input and output capacitors, and using passive filtering techniques.

Load Transient Considerations

The G913 load-transient response graphs show two components of the output response: a DC shift of the output voltage due to the different load currents, and the transient response. Typical overshoot for step changes in the load current from 0mA to 100mA is 12mV. Increasing the output capacitor’s value and decreasing its ESR attenuates transient spikes.

Input-Output (Dropout) Voltage

A regulator’s minimum input-output voltage differential (or dropout voltage) determines the lowest usable supply voltage. In battery-powered systems, this will determine the useful end-of-life battery voltage. Because the G913 use a P-channel MOSFET pass transistor, their dropout voltage is a function of $R_{DS(ON)}$ multiplied by the load current.

Layout Guide

An input capacitance of $\cong 1\mu\text{F}$ is required between the G913 input pin and ground (the amount of the capacitance may be increased without limit), This capacitor must be located a distance of not more than 1cm from the input and return to a clean analog ground.

Input capacitor can filter out the input voltage spike caused by the surge current due to the inductive effect of the package pin and the printed circuit board's routing wire. Otherwise, the actual voltage at the IN pin may exceed the absolute maximum rating.

The output capacitor also must be located a distance of not more than 1cm from output to a clean analog ground. Because it can filter out the output spike caused by the surge current due to the inductive effect of the package pin and the printed circuit board's routing wire. Figure 6 is adjustable mode of G913 PCB layout. Figure 7 is a PCB layout of G913 fixed mode.

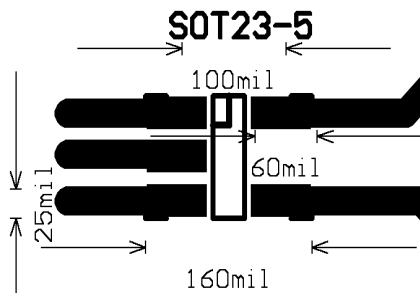

Figure 3. Recommended Minimum Footprint

Safe Operating Area of G913 [Power Dissipation Limit]

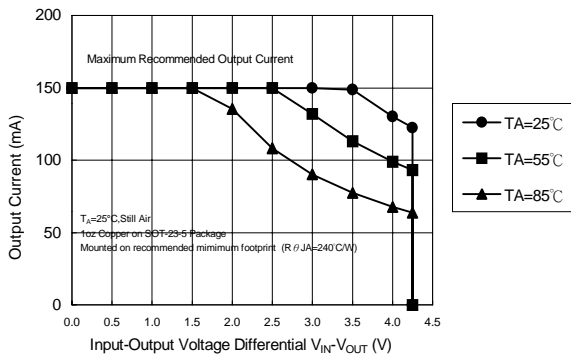

Figure 4 Safe Operating Area

Maximum Power Dissipation of SOT-23-5

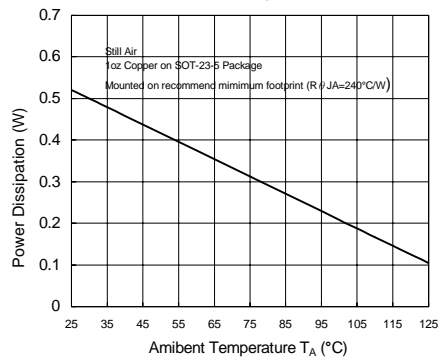

Figure 5 Power Dissipation vs. Temperature

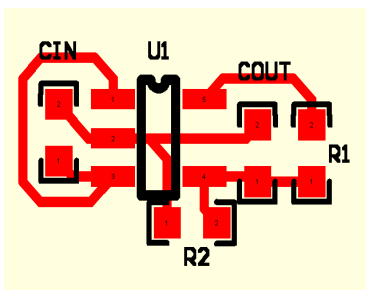

Figure 6. Adjustable Mode

*Distance between pin & capacitor must no more than 1cm

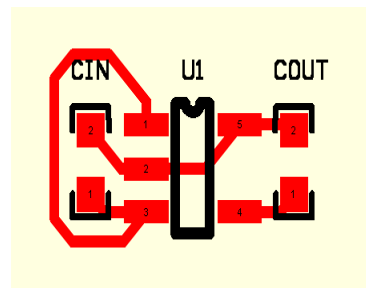
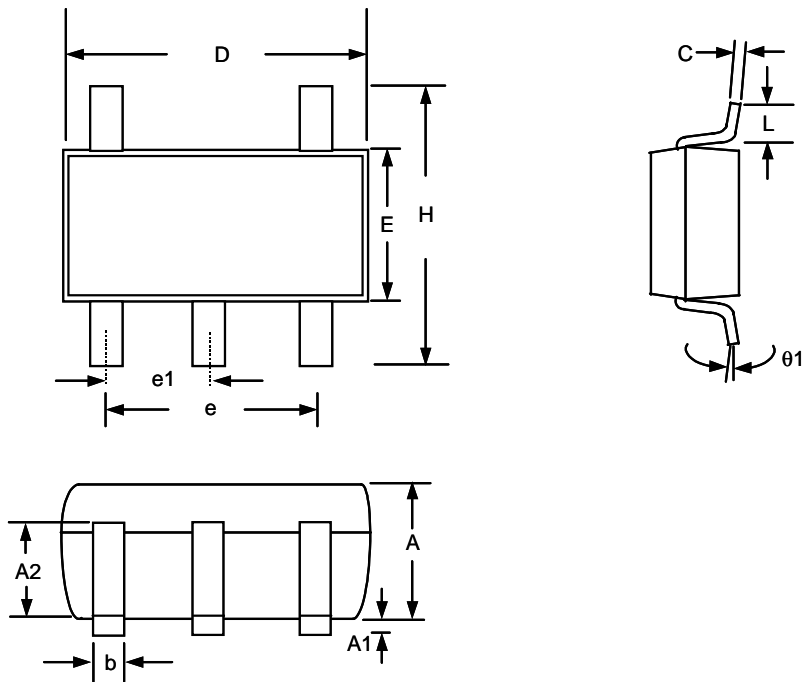

Figure 7. Fixed Mode

*Distance between pin & capacitor must no more than 1cm

Package Information



Note:

1. Package body sizes exclude mold flash protrusions or gate burrs
2. Tolerance ± 0.1000 mm (4mil) unless otherwise specified
3. Coplanarity: 0.1000mm
4. Dimension L is measured in gage plane

SYMBOLS	DIMENSIONS IN MILLIMETERS		
	MIN	NOM	MAX
A	1.00	1.10	1.30
A1	0.00	-----	0.10
A2	0.70	0.80	0.90
b	0.35	0.40	0.50
C	0.10	0.15	0.25
D	2.70	2.90	3.10
E	1.40	1.60	1.80
e	-----	1.90(TYP)	-----
e1	-----	0.95	-----
H	2.60	2.80	3.00
L	0.37	-----	-----
$\theta 1$	1°	5°	9°

Taping Specification

