

### STANDARD RECOVERY DIODES

Stud Version

#### Features

- High surge current capability
- Avalanche types available
- Stud cathode and stud anode version
- Wide current range
- Types up to 1200V  $V_{RRM}$

25 A

#### Typical Applications

- Battery charges
- Converters
- Power supplies
- Machine tool controls

#### Major Ratings and Characteristics

Parameters	25F(R)	Units
$I_{F(AV)}$	25	A
@ $T_C$	120	°C
$I_{F(RMS)}$	40	A
$I_{FSM}$ @ 50Hz	356	A
@ 60Hz	373	A
$I^2t$ @ 50Hz	636	A <sup>2</sup> s
@ 60Hz	580	A <sup>2</sup> s
$V_{RRM}$ range	100 to 1200	V
$T_J$ range	- 65 to 175	°C



**ELECTRICAL SPECIFICATIONS**

Voltage Ratings

Type number	Voltage Code	V <sub>RRM</sub> : maximum repetitive peak reverse voltage V	V <sub>RSM</sub> : maximum non-repetitive peak reverse voltage V	V <sub>R(BR)</sub> : minimum avalanche voltage V (1)	I <sub>RRM</sub> max. @ T <sub>J</sub> = 175°C mA
25F(R)	10	100	150	--	12
	20	200	275	--	
	40	400	500	500	
	60	600	725	750	
	80	800	950	950	
	100	1000	1200	1150	
	120	1200	1400	1350	

(1) Avalanche version only available from V<sub>RRM</sub> 400V to 1200V.

Forward Conduction

Parameter	25F(R)	Units	Conditions
I <sub>F(AV)</sub> Max. average forward current @ Case temperature	25	A	180° conduction, half sine wave
	120	°C	
I <sub>F(RMS)</sub> Max. RMS forward current	40	A	
P <sub>R</sub> Maximum non-repetitive peak reverse power	10	K/W	10µs square pulse, T <sub>J</sub> = T <sub>J</sub> max. <b>see note (2)</b>
I <sub>FSM</sub> Max. peak, one-cycle forward, non-repetitive surge current	356	A	t = 10ms No voltage
	373		t = 8.3ms reapplied
	300		t = 10ms 100% V <sub>RRM</sub>
	314		t = 8.3ms reapplied
I <sup>2</sup> t Maximum I <sup>2</sup> t for fusing	636	A <sup>2</sup> s	t = 10ms No voltage
	580		t = 8.3ms reapplied
	450		t = 10ms 100% V <sub>RRM</sub>
	410		t = 8.3ms reapplied
I <sup>2</sup> √t Maximum I <sup>2</sup> √t for fusing	6360	A <sup>2</sup> √s	t = 0.1 to 10ms, no voltage reapplied
	V <sub>F(TO)1</sub> Low level value of threshold voltage	0.80	V
V <sub>F(TO)2</sub> High level value of threshold voltage	0.90	(I > π × I <sub>F(AV)</sub> ), T <sub>J</sub> = T <sub>J</sub> max.	
r <sub>f1</sub> Low level value of forward slope resistance	6.80	mΩ	(16.7% × π × I <sub>F(AV)</sub> ) < I < π × I <sub>F(AV)</sub> , T <sub>J</sub> = T <sub>J</sub> max.
r <sub>f2</sub> High level value of forward slope resistance	5.70		(I > π × I <sub>F(AV)</sub> ), T <sub>J</sub> = T <sub>J</sub> max.
V <sub>FM</sub> Max. forward voltage drop	1.30	V	I <sub>pk</sub> = 78A, T <sub>J</sub> = 25°C, t <sub>p</sub> = 400µs rectangular wave

(2) Available only for Avalanche version, all other parameters the same as 25F.

Thermal and Mechanical Specifications

Parameter	25F(R)	Units	Conditions
T <sub>J</sub> Max. junction operating temperature range	-65 to 175	°C	
T <sub>stg</sub> Max. storage temperature range	-65 to 200		
R <sub>thJC</sub> Max. thermal resistance, junction to case	1.5	K/W	DC operation
R <sub>thCS</sub> Max. thermal resistance, case to heatsink	0.5		Mounting surface, smooth, flat and greased
T Mounting torque, ± 10%	1.2 (1.5)	Nm	Lubricated threads (Not lubricated threads)
wt Approximate weight	7 (0.25)	g (oz)	
Case style	DO-203AA (DO-4)		See Outline Table

$\Delta R_{thJC}$  Conduction

(The following table shows the increment of thermal resistance R<sub>thJC</sub> when devices operate at different conduction angles than DC)

Conduction angle	Sinusoidal conduction	Rectangular conduction	Units	Conditions
180°	0.28	0.24	K/W	T <sub>J</sub> = T <sub>J</sub> max.
120°	0.39	0.41		
90°	0.50	0.54		
60°	0.73	0.75		
30°	1.20	1.21		

Ordering Information Table

**Device Code**

A	25	F	R	120	M
①	②	③	④	⑤	⑥

- 1** - A = Avalanche diode  
None = Standard diode
- 2** - Current rating: Code = I<sub>F(AV)</sub>
- 3** - F = Standard device
- 4** - None = Stud Normal Polarity (Cathode to Stud)  
R = Stud Reverse Polarity (Anode to Stud)
- 5** - Voltage code: Code x 10 = V<sub>RRM</sub> (See Voltage Ratings table)
- 6** - None = Stud base DO-203AA (DO-4) 10-32UNF-2A  
M = Stud base DO-203AA (DO-4) M5 X 0.8 - (Not available for Avalanche diodes)

# 25F(R) Series

Bulletin I2018 rev. B 09/98

## Outlines Table

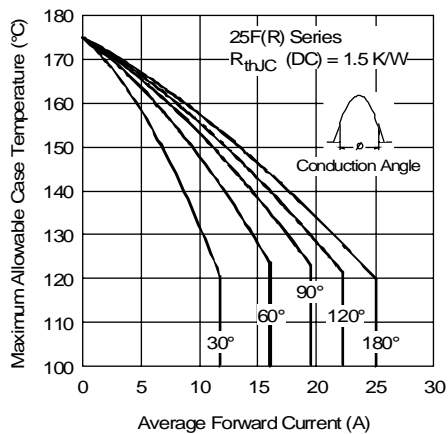
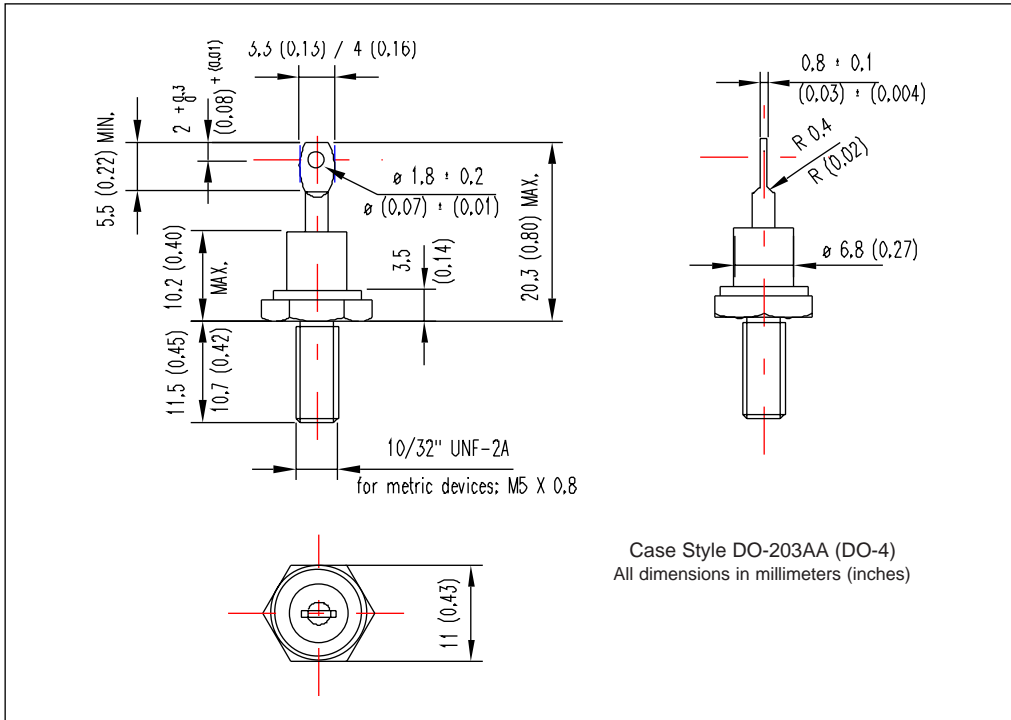

Fig. 1 - Current Ratings Characteristics

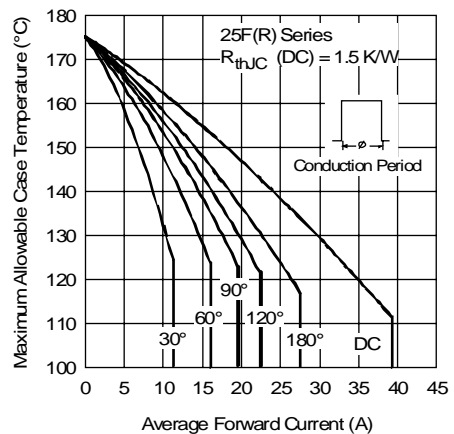

Fig. 2 - Current Ratings Characteristics

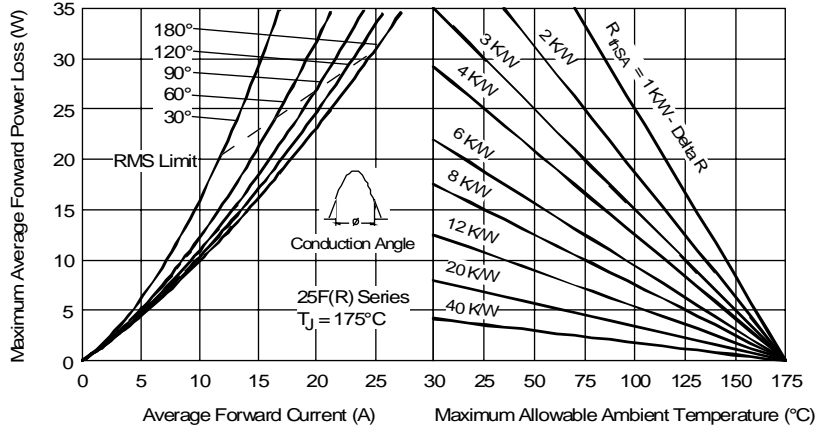

Fig. 3 - Forward Power Loss Characteristics

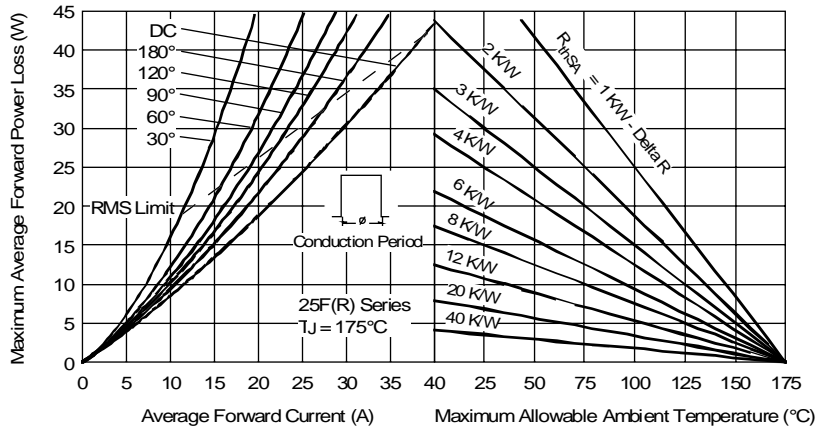

Fig. 4 - Forward Power Loss Characteristics

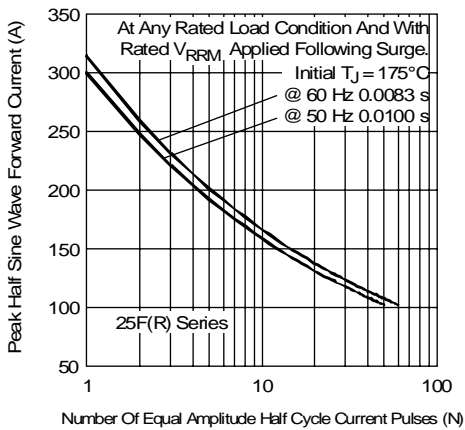

Fig. 5 - Maximum Non-Repetitive Surge Current

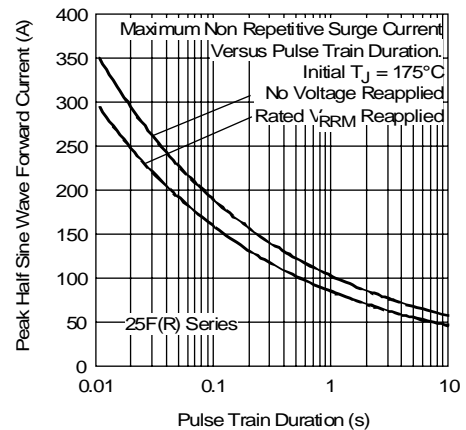

Fig. 6 - Maximum Non-Repetitive Surge Current

## 25F(R) Series

Bulletin I2018 rev. B 09/98

International  
**IR** Rectifier

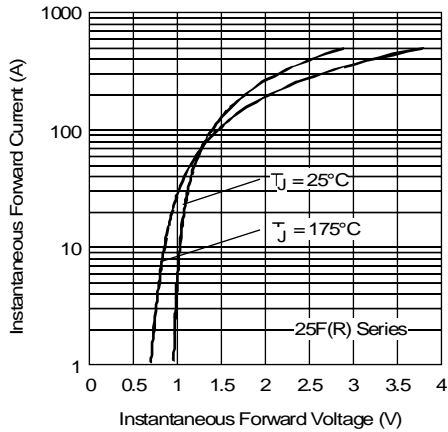

Fig. 7 - Forward Voltage Drop Characteristics

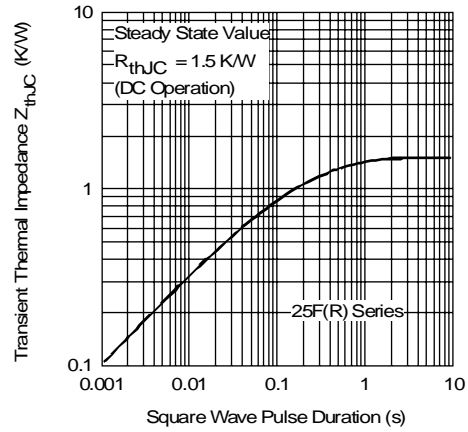

Fig. 8 - Thermal Impedance  $Z_{thJC}$  Characteristics

International  
**IR** Rectifier

**WORLDHEADQUARTERS:** 233 Kansas St., El Segundo, California 90245 U.S.A. Tel: (310) 322 3331. Fax: (310) 322 3332.  
**EUROPEANHEADQUARTERS:** Hurst Green, Oxted, Surrey RH8 9BB, U.K. Tel: ++ 44 1883 732020. Fax: ++ 44 1883 733408.

**IR CANADA:** 15 Lincoln Court, Brampton, Markham, Ontario L6T3Z2. Tel: (905) 453 2200. Fax: (905) 475 8801.

**IR GERMANY:** Saalburgstrasse 157, 61350 Bad Homburg. Tel: ++ 49 6172 96590. Fax: ++ 49 6172 965933.

**IR ITALY:** Via Liguria 49, 10071 Borgaro, Torino. Tel: ++ 39 11 4510111. Fax: ++ 39 11 4510220.

**IR FAR EAST:** K&H Bldg., 2F, 30-4 Nishi-Ikebukuro 3-Chome, Toshima-Ku, Tokyo, Japan 171. Tel: 81 3 3983 0086.

**IR SOUTHEAST ASIA:** 1 Kim Seng Promenade, Great World City West Tower, 13-11, Singapore 237994. Tel: ++ 65 838 4630.

**IR TAIWAN:** 16 Fl. Suite D.207, Sec. 2, Tun Haw South Road, Taipei, 10673, Taiwan. Tel: 886 2 2377 9936.

<http://www.irf.com>

Fax-On-Demand: +44 1883 733420

Data and specifications subject to change without notice.

This datasheet has been download from:

[www.datasheetcatalog.com](http://www.datasheetcatalog.com)

Datasheets for electronics components.