

5330H Series Variable Height LED T-1 3/4 (5mm) Lamp Assembly

DESCRIPTION AND FEATURES

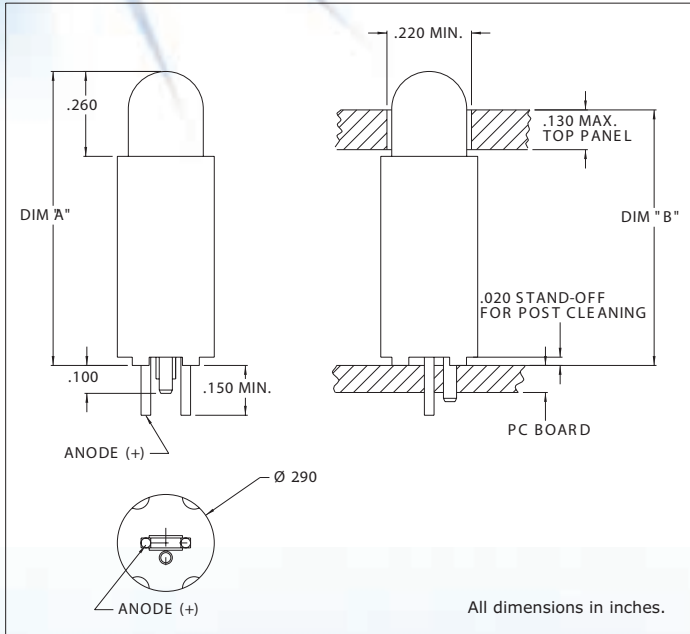

Features

- Block mounting design and spacing-alignment saves assembly cost and time.
- Super Brite T-1 3/4 diffused LED-wide angle viewing.
- Press-in mounting pin secures assembly to PC board while being soldered.
- Standoffs prevent flux entrapment.

Housing: Black Nylon, UL94V-O

Mounting hole pattern on page 1-X6.

ELECTRO-OPTICAL CHARACTERISTICS AND RATINGS

Part Number	Color	Typ. Intensity (mcd)	Rated Current (mA)	Continuous Forward Current Max. (mA)	Forward Voltage Typ. (V)	Forward Voltage Max. (V)	Peak Forward Current @ 1ms-300pps (A)	Reverse Break-down Voltage Min. (V)	Peak Wavelength (nm)	DIM A (inches)	DIM B (inches)
5330H1	Red	30	20	35	2.0	3.0	1.0	5	635	.870	.750
5330H3	Amber	20	20	35	2.0	3.0	1.0	5	608	.870	.750
5330H5	Green	30	20	30	2.2	3.0	.09	5	562	.870	.750
5330H7	Yellow	25	20	35	2.2	3.0	1.0	5	585	.870	.750
5330H1LC	Red	2.0	2	7	1.8	2.2	.007	5	635	.870	.750
5330H5LC	Green	2.5	2	7	1.8	2.2	.007	5	562	.870	.750
5330H7LC	Yellow	2.0	2	7	1.9	2.7	.007	5	585	.870	.750
5330H1-5V	Red	6.0	10	15	5	7.5	-	5	635	.870	.750
5330H3-5V	Amber	7.0	10	15	5	7.5	-	5	583	.870	.750
5330H5-5V	Green	10.0	10	15	5	7.5	-	5	565	.870	.750
5335H1	Red	30	20	35	2.0	3.0	1.0	5	635	.570	.450
5335H3	Amber	20	20	35	2.0	3.0	1.0	5	603	.570	.450
5335H5	Green	30	20	30	2.2	3.0	.09	5	562	.570	.450
5335H7	Yellow	25	20	35	2.2	3.0	1.0	5	585	.570	.450
5335H1LC	Red	2.0	2	7	1.8	3.3	.007	5	635	.570	.450
5335H5LC	Green	2.5	2	7	1.8	3.3	.007	5	562	.570	.450
5335H1LC	Yellow	2.0	2	7	1.9	3.7	.007	5	585	.570	.450
5335H1-5V	Red	6.0	10	15	5	7.5	-	5	635	.570	.450
5335H3-5V	Amber	7.0	10	15	5	7.5	-	5	583	.570	.450
5335H5-5V	Green	10.0	10	15	5	7.5	-	5	562	.570	.450