

**Ultra Low Dropout, 7.0 A
 Adjustable Positive Linear Regulator
 Surface-Mount (SMD-6)**

**OM7580SM
 5962 - 0323701MXA**

Product Summary

Part Number	Output Voltage	Current	Dropout
OM7580SM	+1.8V to +5.5V	7.0A	0.54V

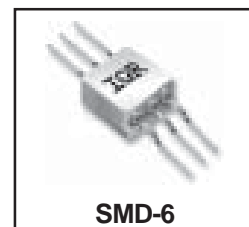

Description

The OM7580SM is a 7.0A , ultra low dropout, adjustable linear regulator specifically designed for low voltage, high current applications. Housed in a hermetic package, the dropout of this device is 540mV at full load and as low a 100mV at light loads. The low dropout is achieved by an additional low current input voltage. This unit is ideally suited for military/defense, commercial aircraft, industrial control and other harsh environments where a hermetically sealed package is required.

Features:

- Dropout Voltage of 540mV at Full Load
- Dropout Voltage of 100mV at Light Loads
- Fast Transient Response
- Adjustable Output: 1.8 to 5.5V
- Remote Sense
- Hermetic SMD-6 Package ensures High Reliability

Absolute Maximum Ratings

Parameter	Symbol	Value	Units
Output Current	I_O	7.0	A
Power Input Voltage	V_{PWR}	6.0	V
Control Input Voltage	V_{CTRL}	13	
Power Dissipation @ $T_c = 25^\circ\text{C}$	P_D	20	W
Thermal Resistance, Junction to Case	$R_{\theta JC}$	5.0	$^\circ\text{C}/\text{W}$
Operating Junction Temperature Range	T_J	-55 to +125	$^\circ\text{C}$
Storage Temperature Range	T_{STG}	-65 to +150	
Lead Temperature Soldering (10second maximum)	T_L	300	

Electrical Characteristics @T_A = 25°C (Unless Otherwise Specified)

Parameter	Test Conditions	Min.	Typ.	Max.	Units
Reference Voltage	V _{CTRL} = 2.7V, V _{PWR} = 2.0V, I _{LOAD} = 10mA	1.243	1.250	1.257	V
V _{ADJ} = 0V	V _{CTRL} = 2.7 to 12V, V _{PWR} = 1.75V to 5.5V, I _{LOAD} = 10mA to 6.0A ①	1.237	1.250	1.263	
Line Regulation	V _{CTRL} = 2.5 to 12V, V _{PWR} = 3.0V to 5.5V, I _{LOAD} = 1.0mA ①	--	1.0	3.0	mV
Load Regulation	V _{CTRL} = 2.75V, V _{PWR} = 2.1V, I _{LOAD} = 10mA to 6.0A ①	--	1.0	5.0	
Minimum Load Current	V _{CTRL} = 5.0V, V _{PWR} = 3.3V, V _{ADJ} = 0V ①②	--	5.0	10	mA
Ground Pin Current	V _{CTRL} = 5.0V, V _{PWR} = 3.3V, I _{LOAD} = 0mA ①	--	6.0	10	
Control Pin Current ③	V _{CTRL} = 2.75V, V _{PWR} = 2.05V, I _{LOAD} = 7.0A, T _J = 25°C	--	--	120	
	V _{CTRL} = 2.75V, V _{PWR} = 2.05V, I _{LOAD} = 7.0A, T _J = 125°C	--	--	120	
	V _{CTRL} = 2.75V, V _{PWR} = 2.05V, I _{LOAD} = 6.0A, T _J = -55°C	--	--	130	
Adjust Pin Current V _{ADJ} = 0V	V _{CTRL} = 2.75V, V _{PWR} = 2.05V, I _{LOAD} = 10mA	--	50	120	μA
Ripple Rejection	V _{CTRL} = V _{PWR} = 5.0V (AVG), V _{RIPPLE} = 1.0V _{P-P} , f = 120Hz I _{OUT} = 4.0A T _J = 25°C	60	80	--	dB
Current Limit	V _{CTRL} = 2.75V, V _{PWR} = 2.05V, ΔV _{OUT} = 100mV, T _J = 25°C	7.1	8.0	--	A
	V _{CTRL} = 2.75V, V _{PWR} = 2.05V, ΔV _{OUT} = 100mV, T _J = -55°C & T _J = +125°C	6.6	--	--	
Minimum V _{CONTROL}	V _{PWR} = 3.3V, I _{LOAD} = 7.0A, T _J = 25°C	--	--	1.33	V
	V _{PWR} = 3.3V, I _{LOAD} = 7.0A, T _J = 125°C	--	--	1.33	
	V _{PWR} = 3.3V, I _{LOAD} = 6.0A, T _J = -55°C	--	--	1.35	
Minimum V _{PWR}	V _{CTRL} = 2.75V, I _{LOAD} = 7.0A, T _J = 25°C	--	--	0.62	V
	V _{CTRL} = 2.75V, I _{LOAD} = 7.0A, T _J = 125°C	--	--	0.80	
	V _{CTRL} = 2.75V, I _{LOAD} = 6.0A, T _J = -55°C	--	--	0.80	
Thermal Regulation	V _{PWR} = 5.0V, I _O = 7.0A, P _D ≥ 20W, pulse width = 30ms	--	--	0.02	%/W
Dropout Voltage	Dropout is caused by either minimum control voltage or minimum power voltage. Both parameters are specified with respect to the output voltage. The specifications represent the minimum input/output voltage required to maintain 1% regulation.				

Footnotes

- ①- Denotes specifications which apply over the full operating temperature range.
- ②- The minimum load current is minimum current required to maintain regulation. Normally the current in the resistor divider used to set the output voltage is selected to meet the minimum load current requirement.
- ③- The control pin current is the drive current required for the output transistor. The control pin current is approximately 0.01% output current. The minimum value is equal to quiescent current of the device.

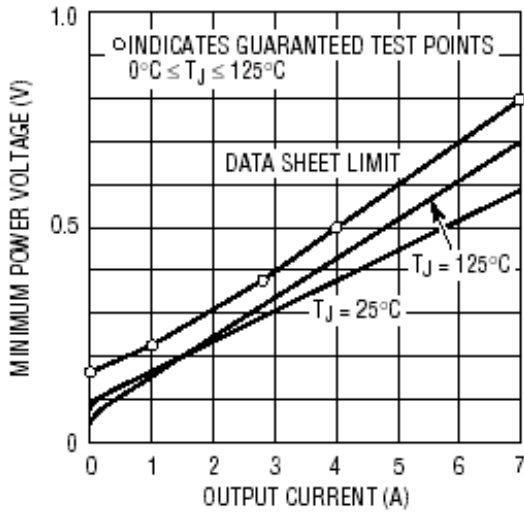

Fig 1: Typical Power Voltage Vs Output Current

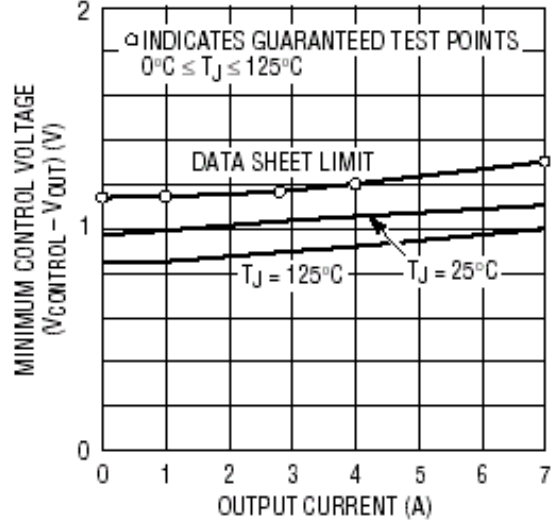

Fig 2: Typical Control Voltage Vs Output Current

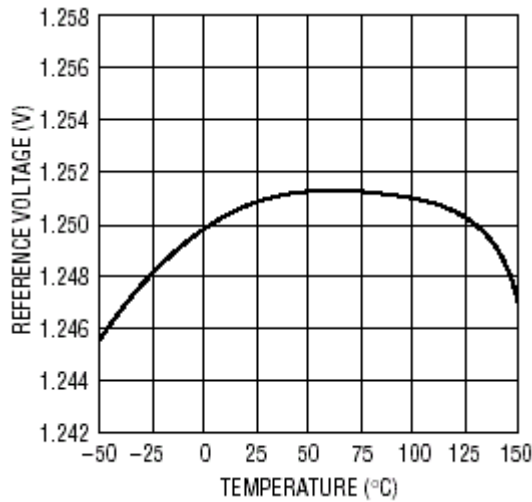

Fig 3: Typical Reference Voltage Vs Temperature

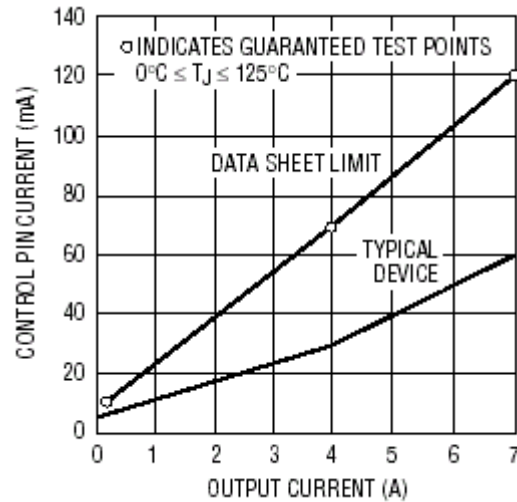
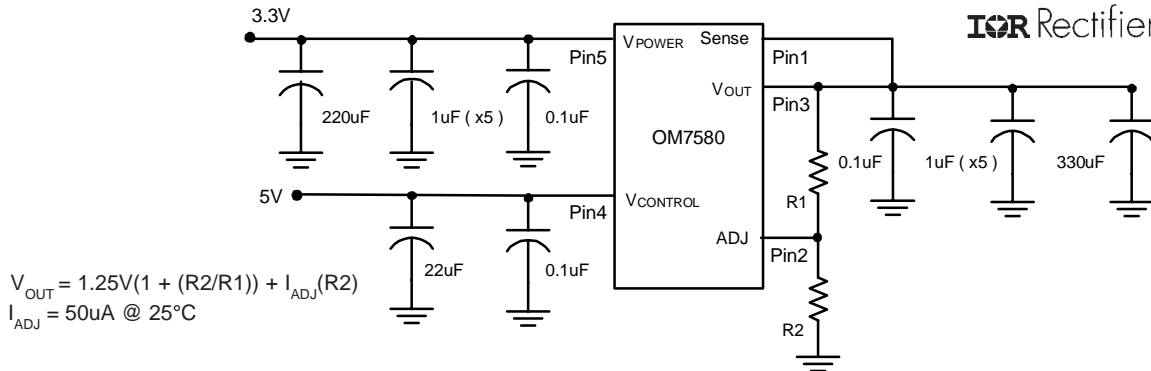

Fig 4: Typical Control Pin Current Vs Output Current

OM7580SM

International
IR Rectifier



$$V_{OUT} = 1.25V(1 + (R2/R1)) + I_{ADJ}(R2)$$

$$I_{ADJ} = 50\mu A @ 25^{\circ}C$$

Fig 5: Typical Application

Layout Consideration

It is recommended that output capacitors be located as close as possible to the V_{OUT} terminal of the device to prevent any high frequency oscillation that may result due to excessive stray inductance. Specifications for capacitors: 330μF Tantalum Low ESR, 220μF Electrolytic, 22μF Electrolytic

Case Outline and Dimensions — SMD-6

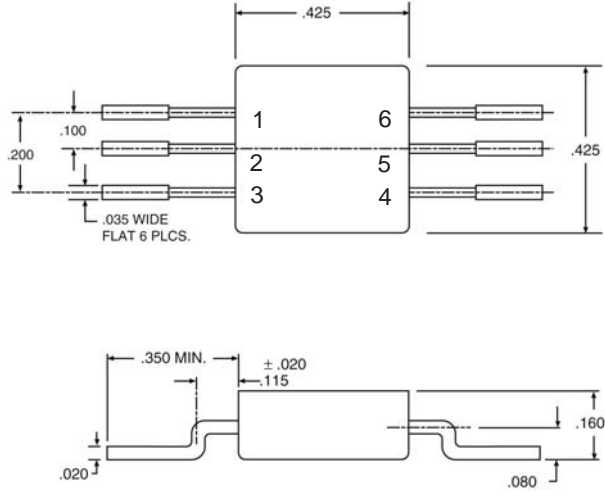

Pin Assignment

Pin #	Pin Description
1	ADJUST
2	V _{OUT}
3	V _{CTRL}
4	V _{PWR}
5	N/C
6	SENSE

Part Numbering Nomenclature

OM	7580	S	M	X
Omnirel	Device	S=Isolated	Package	Screening

International
IR Rectifier

WORLD HEADQUARTERS: 233 Kansas St., El Segundo, California 90245, Tel: (310) 252-7105
IR LEOMINSTER: 205 Crawford St., Leominster, Massachusetts 01453, Tel: (978) 534-5776
Data and specifications subject to change without notice. 08/03