

10BASE-T NETWORK COMPONENTS

960051B

- Designed for use with Level One 10Base-T chipset LXT901 LXT907, LXT914 or Texas Instruments Quad PHY (TNETE 2004)
- 1:1 or 1:√2 turns ratio on transmit, 1:1 turns ratio on receive
- Single port components, available with and without common mode chokes
- Through-hole and surface mount packaging
- Models with additional differential filtering available
- 2000 Vrms isolation

ELECTRICALS AT 25°C

Part No.	Insertion Loss (dB) Max		Return Loss (dB) Min	Crosstalk (dB) Min	Attenuation (dB) Min			CM-CM Rej (dB) Min		Package Style
	1-10MHz	OCL (μH) Min			1-10MHz	1MHz-10MHz	25	30	40	
A553-0716-00	-1.0	140	-18	-40	N/A	N/A	N/A	N/A	A	1
A553-5999-64	-1.0	200	-18	-40	N/A	N/A	N/A	N/A	A	1
S553-0716-00	-1.0	140	-18	-40	N/A	N/A	N/A	N/A	A	2
S553-5999-08	-1.0	110	-15	-40	N/A	-40	-30	B	2	
S556-5999-26	-1.0	110	-15	-40	-5	-10	-16	C	2	
S556-5999-53	-1.0	110	-15	-40	-5	-10	-16	C	3	

SCHEMATICS

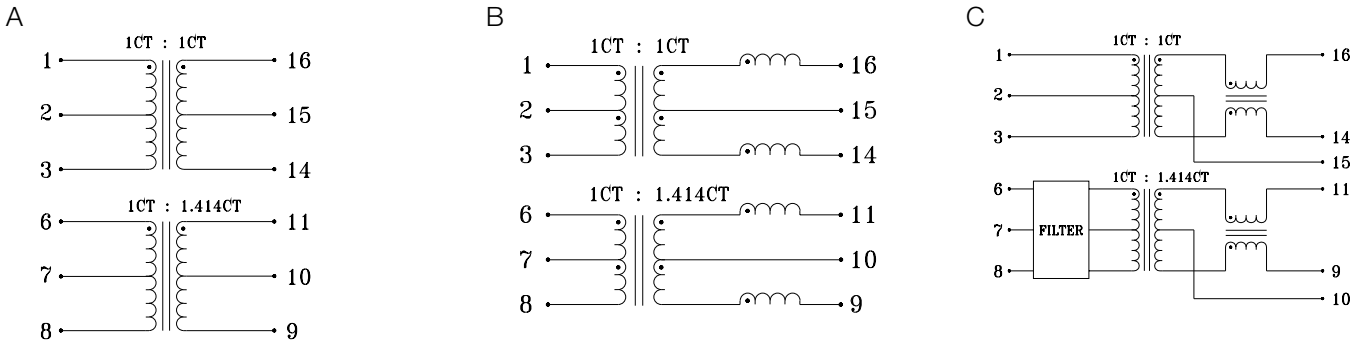

MECHANICALS

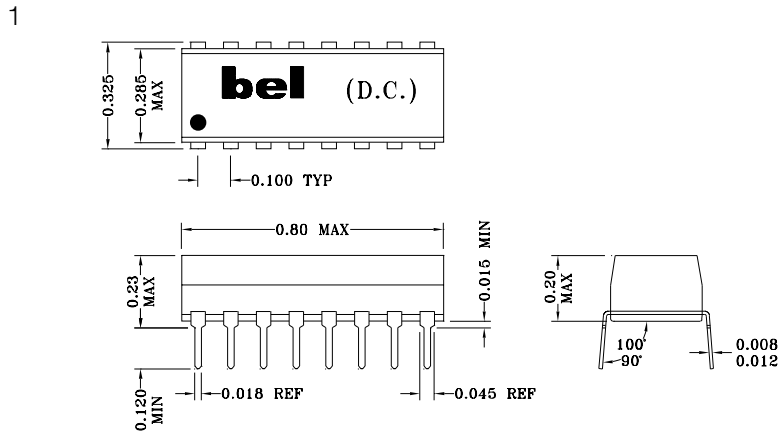

Specifications subject to change without notice.

10BASE-T NETWORK COMPONENTS

960051B

MECHANICALS (CONT'D)

2

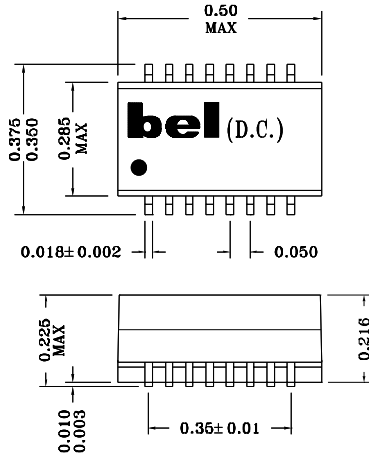

SUGGESTED PCB PAD LAYOUT

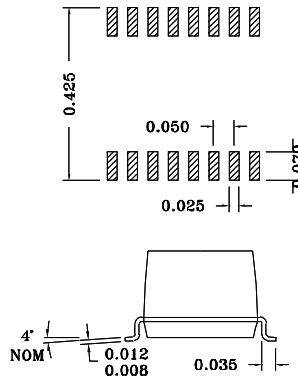

3

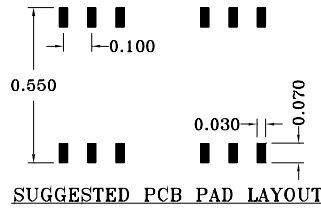
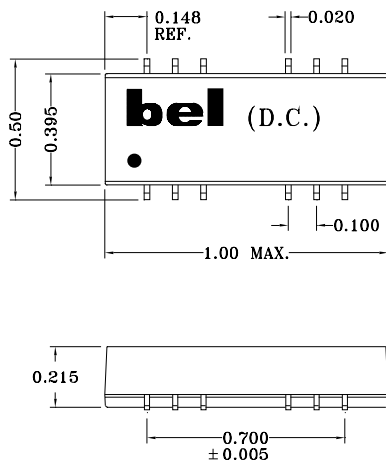

Specifications subject to change without notice.

10BASE-T NETWORK COMPONENTS

APPLICATION CIRCUIT

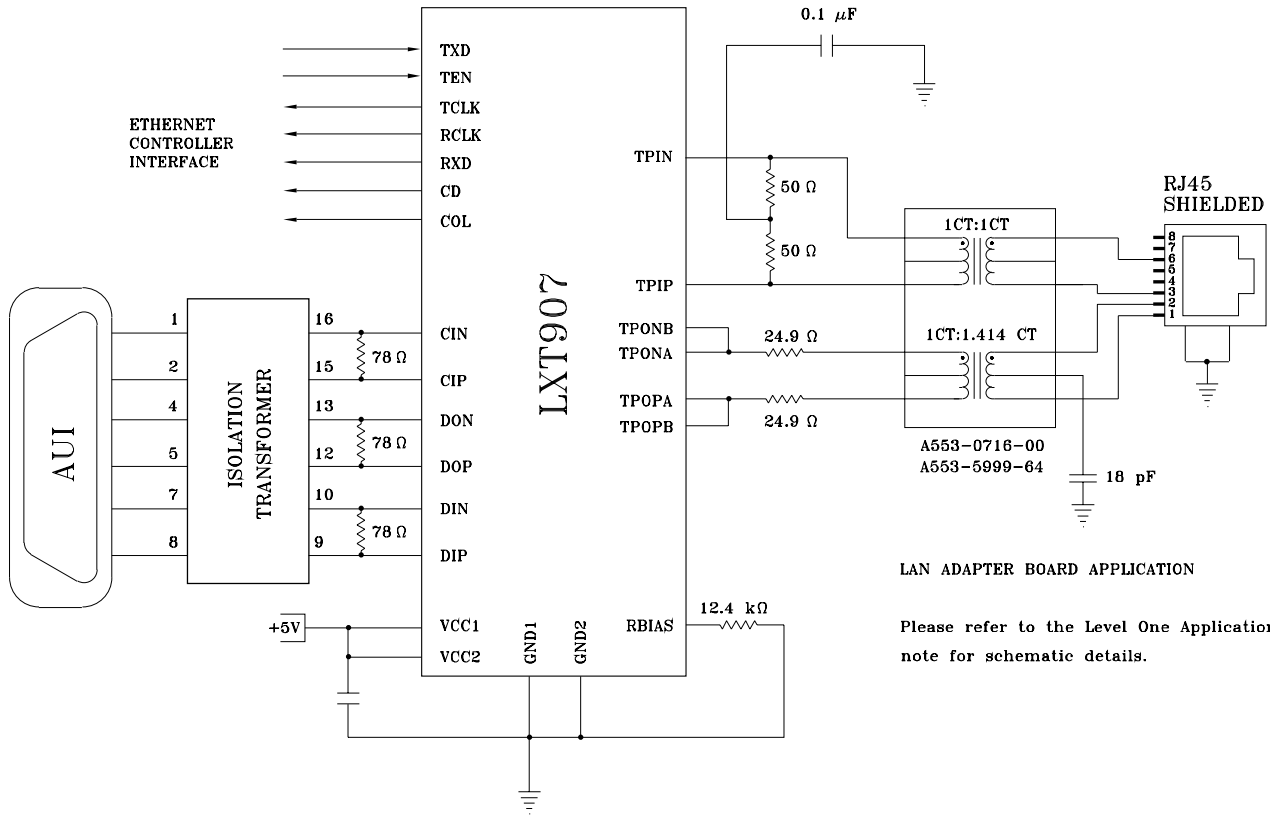

LAN ADAPTER BOARD APPLICATION

Please refer to the Level One Application note for schematic details.

Specifications subject to change without notice.



defining a degree of excellence

10BASE-T NETWORK COMPONENTS

960051B

APPLICATION NOTES

- All designs meet IEEE 802.3 standards.
- Models with additional differential filtering are typically used in high density, multi-port applications or high noise content adapter cards.
- Bel's low profile, surface mount packaging is ideal for high speed pick and place machinery. Parts can be shipped on tape and reel for high speed placement. Construction processes have been implemented for thermal compatibility with high temperature IR reflow assembly processing. Post dipping of leads assist with PC board solderability. Each part is optically inspected to meet rigid coplanarity requirements.

Corporate Office

Bel Fuse Inc.

198 Van Vorst Street, Jersey City, NJ 07302-4496

Tel: 201-432-0463

Fax: 201-432-9542

E-Mail: BelFuse@belfuse.com

Internet: <http://www.belfuse.com>

Far East Office

Bel Fuse Ltd.

8F/8 Luk Hop Street

San Po Kong

Kowloon, Hong Kong

Tel: 852-2328-5515

Fax: 852-2352-3706

European Office

Bel Fuse Europe Ltd.

Preston Technology Management Centre

Marsh Lane, Preston PR1 8UD

Lancashire, U.K.

Tel: 44-1772-556601

Fax: 44-1772-888366