

EPC3215G-X



Actual Size

- Used as Trigger Transformer in Photoflash Circuits
- Operating Temperature : -40°C to +85°C
- UL 94V-0 Recognized Components
- UL 1446 Class B Insulation System

Electrical Parameters @ 25° C

PCA Part Number	Voltage (Vdc) V in	Peak Trigger Voltage (V Min.)	Primary OCL @ 0A _{dc} (μH Typ.) @ 100 KHz, 0.1 V _{rms}	DCR (Ω Typ.)		Package/ Schematic
				Pri.	Sec.	
EPC3215G-1	300	4000	1.2	0.86	140	A/1
EPC3215G-2	300	4000	1.2	0.86	140	A/2
EPC3215G-3	300	4000	1.7	0.90	169	B/3

Package A

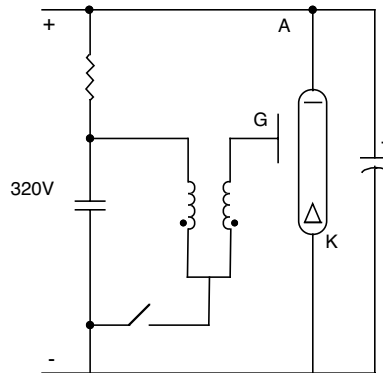
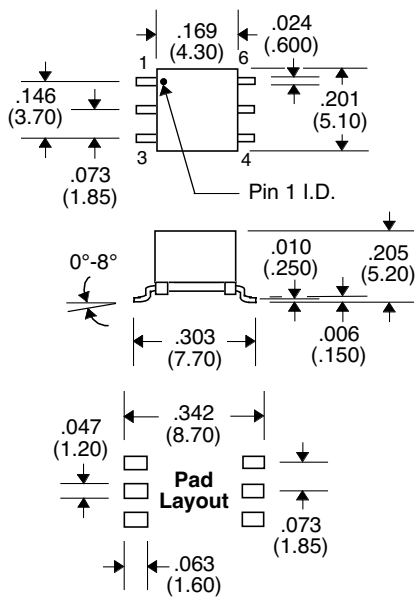

Schematic 1

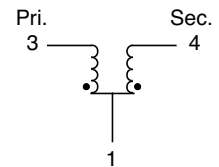

• DANGER HIGH VOLTAGE •
Operation By High Voltage
Trained Personnel Only

Schematic 2

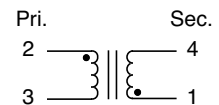

Package B

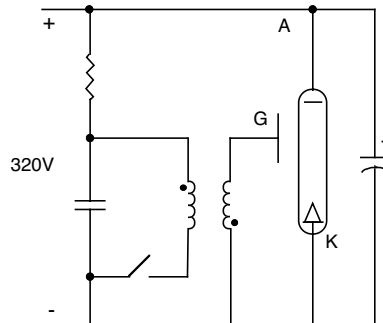
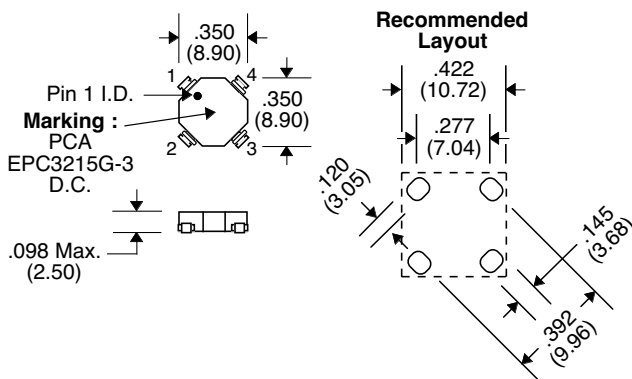

Schematic 3

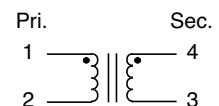

Unless Otherwise Specified Dimensions are in Inches /mm ±.010 /.25