

FEATURES

- Low power octal DAC with
 - Four 16-bit DACs
 - Four 12-bit DACs
- 14-lead/16-lead TSSOP
- On-chip 1.25 V/2.5 V, 5 ppm/°C reference
- Power down to 400 nA @ 5 V, 200 nA @ 3 V
- 2.7 V to 5.5 V power supply
- Guaranteed monotonic by design
- Power-on reset to zero scale
- 3 power-down functions
- Hardware $\overline{\text{LDAC}}$ and $\overline{\text{LDAC}}$ override function
- $\overline{\text{CLR}}$ function to programmable code
- Rail-to-rail operation

APPLICATIONS

- Process control
- Data acquisition systems
- Portable battery-powered instruments
- Digital gain and offset adjustment
- Programmable voltage current sources
- Programmable attenuators

GENERAL DESCRIPTION

The AD5678 is a low power, octal, buffered voltage-output DAC with four 12-bit DACs and four 16-bit DACs in a single package. All devices operate from a single 2.7 V to 5.5 V supply and are guaranteed monotonic by design.

The AD5678 has an on-chip reference with an internal gain of 2. The AD5678-1 has a 1.25 V 5 ppm/°C reference, giving a full-scale output of 2.5 V; the AD5678-2 has a 2.5 V 5 ppm/°C reference, giving a full-scale output of 5 V. The on-board reference is off at power-up, allowing the use of an external reference. The internal reference is enabled via a software write.

The part incorporates a power-on reset circuit that ensures that the DAC output powers up to 0 V and remains powered up at this level until a valid write takes place. The part contains a power-down feature that reduces the current consumption of the device to 400 nA at 5 V and provides software-selectable output loads while in power-down mode for any or all DAC channels.

Rev. A

Information furnished by Analog Devices is believed to be accurate and reliable. However, no responsibility is assumed by Analog Devices for its use, nor for any infringements of patents or other rights of third parties that may result from its use. Specifications subject to change without notice. No license is granted by implication or otherwise under any patent or patent rights of Analog Devices. Trademarks and registered trademarks are the property of their respective owners.

FUNCTIONAL BLOCK DIAGRAM

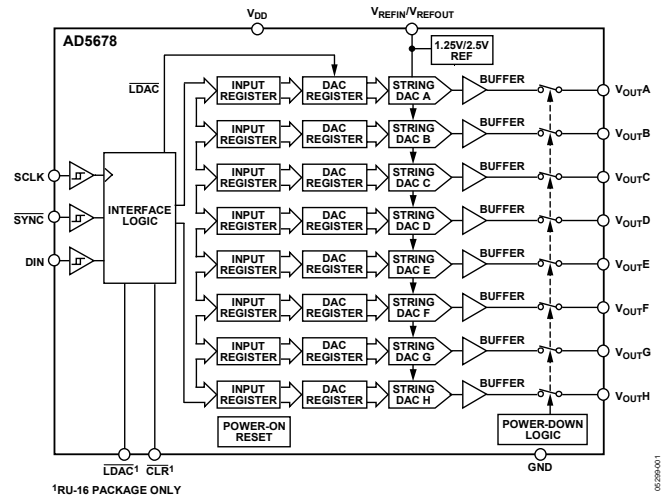

Figure 1.

The outputs of all DACs can be updated simultaneously using the $\overline{\text{LDAC}}$ function, with the added functionality of user-selectable DAC channels to simultaneously update. There is also an asynchronous $\overline{\text{CLR}}$ that clears all DACs to a software-selectable code—0 V, midscale, or full scale.

The AD5678 utilizes a versatile 3-wire serial interface that operates at clock rates of up to 50 MHz and is compatible with standard SPI®, QSPI™, MICROWIRE™, and DSP interface standards. The on-chip precision output amplifier enables rail-to-rail output swing.

PRODUCT HIGHLIGHTS

1. Octal DAC (four 12-bit DACs and four 16-bit DACs).
2. On-chip 1.25 V/2.5 V, 5 ppm/°C reference.
3. Available in 14-lead/16-lead TSSOP.
4. Power-on reset to 0 V.
5. Power-down capability. When powered down, the DAC typically consumes 200 nA at 3 V and 400 nA at 5 V.

TABLE OF CONTENTS

Features	1	D/A Section.....	20
Applications.....	1	Resistor String.....	20
Functional Block Diagram	1	Internal Reference	20
General Description	1	Output Amplifier.....	21
Product Highlights	1	Serial Interface	21
Revision History	2	Input Shift Register	22
Specifications.....	3	$\overline{\text{SYNC}}$ Interrupt	22
AC Characteristics.....	7	Internal Reference Register.....	23
Timing Characteristics	8	Power-On Reset.....	23
Absolute Maximum Ratings.....	9	Power-Down Modes	23
ESD Caution.....	9	Clear Code Register	23
Pin Configuration and Function Descriptions.....	10	$\overline{\text{LDAC}}$ Function	25
Typical Performance Characteristics	11	Power Supply Bypassing and Grounding.....	25
Terminology	18	Outline Dimensions	26
Theory of Operation	20	Ordering Guide	26

REVISION HISTORY

11/05—Rev. 0 to Rev. A

Change to General Description	1
Change to Specifications.....	3
Replaced Figure 48	22
Change to the Power-Down Modes Section	23

10/05—Revision 0: Initial Version

SPECIFICATIONS

$V_{DD} = 4.5\text{ V to }5.5\text{ V}$, $R_L = 2\text{ k}\Omega$ to GND, $C_L = 200\text{ pF}$ to GND, $V_{REFIN} = V_{DD}$. All specifications T_{MIN} to T_{MAX} , unless otherwise noted.

Table 1.

Parameter	A Grade ¹			B Grade ¹			Unit	Conditions/Comments
	Min	Typ	Max	Min	Typ	Max		
STATIC PERFORMANCE²								
AD5678 (DAC C, D, E, F)								
Resolution	12			12			Bits	
Relative Accuracy		±0.5	±2		±0.5	±1	LSB	See Figure 11
Differential Nonlinearity			±0.25			±0.25	LSB	Guaranteed monotonic by design (see Figure 12)
AD5678 (DAC A, B, G, H)								
Resolution	16			16			Bits	
Relative Accuracy		±8	±32		±8	±16	LSB	See Figure 5
Differential Nonlinearity			±1			±1	LSB	Guaranteed monotonic by design (see Figure 6)
Zero-Code Error		1	9		1	9	mV	All 0s loaded to DAC register (see Figure 17)
Zero-Code Error Drift		±2			±2		μV/°C	
Full-Scale Error		-0.2	-1		-0.2	-1	% FSR	All 1s loaded to DAC register (see Figure 18)
Gain Error			±1			±1	% FSR	
Gain Temperature Coefficient		±2.5			±2.5		ppm	Of FSR/°C
Offset Error		±1	±9		±1	±9	mV	
DC Power Supply Rejection Ratio		-80			-80		dB	$V_{DD} \pm 10\%$
DC Crosstalk (External Reference)		10			10		μV	Due to full-scale output change, $R_L = 2\text{ k}\Omega$ to GND or V_{DD}
		5			5		μV/mA	Due to load current change
		10			10		μV	Due to powering down (per channel)
DC Crosstalk (Internal Reference)		25			25		μV	Due to full-scale output change, $R_L = 2\text{ k}\Omega$ to GND or V_{DD}
		10			10		μV/mA	Due to load current change
OUTPUT CHARACTERISTICS³								
Output Voltage Range	0		V_{DD}	0		V_{DD}	V	
Capacitive Load Stability		2			2		nF	$R_L = \infty$
		10			10		nF	$R_L = 2\text{ k}\Omega$
DC Output Impedance		0.5			0.5		Ω	
Short-Circuit Current		30			30		mA	$V_{DD} = 5\text{ V}$
Power-Up Time		4			4		μs	Coming out of power-down mode; $V_{DD} = 5\text{ V}$
REFERENCE INPUTS								
Reference Input Voltage		V_{DD}			V_{DD}		V	±1% for specified performance
Reference Current		35	45		35	45	μA	$V_{REF} = V_{DD} = 5.5\text{ V}$ (per DAC channel)
Reference Input Range	0		V_{DD}	0		V_{DD}	V	
Reference Input Impedance		14.6			14.6		kΩ	Per DAC channel
REFERENCE OUTPUT								
Output Voltage								
AD5678-2	2.495		2.505	2.495		2.505	V	At ambient
Reference TC ³		±5	±10		±5	±10	ppm/°C	
Reference Output Impedance		7.5			7.5		kΩ	
LOGIC INPUTS³								
Input Current			±3			±3	μA	All digital inputs
Input Low Voltage, V_{INL}			0.8			0.8	V	$V_{DD} = 5\text{ V}$
Input High Voltage, V_{INH}	2			2			V	$V_{DD} = 5\text{ V}$
Pin Capacitance		3			3		pF	

AD5678

Parameter	A Grade ¹			B Grade ¹			Unit	Conditions/Comments
	Min	Typ	Max	Min	Typ	Max		
POWER REQUIREMENTS								
V_{DD}	4.5		5.5	4.5		5.5	V	All digital inputs at 0 or V_{DD} , DAC active, excludes load current
I_{DD} (Normal Mode) ⁴								$V_{IH} = V_{DD}$ and $V_{IL} = GND$
$V_{DD} = 4.5\text{ V to }5.5\text{ V}$		1.3	1.8		1.3	1.8	mA	Internal reference off
$V_{DD} = 4.5\text{ V to }5.5\text{ V}$		2	2.5		2	2.5	mA	Internal reference on
I_{DD} (All Power-Down Modes) ⁵								
$V_{DD} = 4.5\text{ V to }5.5\text{ V}$		0.4	1		0.4	1	μA	$V_{IH} = V_{DD}$ and $V_{IL} = GND$

¹ Temperature range is -40°C to $+105^{\circ}\text{C}$, typical at 25°C .

² Linearity calculated using a reduced code range of AD5678 12-bit DACs (Code 32 to Code 4,064) and AD5678 16-bit DACs (Code 512 to Code 65,024). Output unloaded.

³ Guaranteed by design and characterization; not production tested.

⁴ Interface inactive. All DACs active. DAC outputs unloaded.

⁵ All eight DACs powered down.

$V_{DD} = 2.7\text{ V to }3.6\text{ V}$, $R_L = 2\text{ k}\Omega\text{ to GND}$, $C_L = 200\text{ pF to GND}$, $V_{REFIN} = V_{DD}$. All specifications T_{MIN} to T_{MAX} , unless otherwise noted.

Table 2.

Parameter	A Grade ¹			B Grade ¹			Unit	Conditions/Comments
	Min	Typ	Max	Min	Typ	Max		
STATIC PERFORMANCE ²								
AD5678 (DAC C, D, E, F)								
Resolution	12			12			Bits	
Relative Accuracy		±0.5	±2		±0.5	±1	LSB	See Figure 11
Differential Nonlinearity			±1			±1	LSB	Guaranteed monotonic by design (see Figure 12)
AD5678 (DAC A, B, G, H)								
Resolution	16			16			Bits	
Relative Accuracy			±32			±16	LSB	See Figure 5
Differential Nonlinearity			±1			±1	LSB	Guaranteed monotonic by design (See Figure 6)
Zero-Code Error		1	9		1	9	mV	All 0s loaded to DAC register (See Figure 17)
Zero-Code Error Drift		±2			±2		μV/°C	
Full-Scale Error		-0.2	-1		-0.2	-1	% FSR	All 1s loaded to DAC register (See Figure 18)
Gain Error			±1			±1	% FSR	
Gain Temperature Coefficient		±2.5			±2.5		ppm	Of FSR/°C
Offset Error		±1	±9		±1	±9	mV	
Offset Temperature Coefficient		1.7			1.7		μV/°C	
DC Power Supply Rejection Ratio		-80			-80		dB	$V_{DD} \pm 10\%$
DC Crosstalk (External Reference)		10			10		μV	Due to full-scale output change, $R_L = 2\text{ k}\Omega\text{ to GND or }V_{DD}$
		4.5			4.5		μV/mA	Due to load current change
		10			10		μV	Due to powering down (per channel)
DC Crosstalk (Internal Reference)		25			25		μV	Due to full-scale output change, $R_L = 2\text{ k}\Omega\text{ to GND or }V_{DD}$
		4.5			4.5		μV/mA	Due to load current change
OUTPUT CHARACTERISTICS ³								
Output Voltage Range	0		V_{DD}	0		V_{DD}	V	
Capacitive Load Stability		2			2		nF	$R_L = \infty$
		10			10		nF	$R_L = 2\text{ k}\Omega$
DC Output Impedance		0.5			0.5		Ω	
Short-Circuit Current		30			30		mA	$V_{DD} = 3\text{ V}$
Power-Up Time		4			4		μs	Coming out of power-down mode; $V_{DD} = 3\text{ V}$
REFERENCE INPUTS								
Reference Input Voltage		V_{DD}			V_{DD}		V	±1% for specified performance
Reference Current		20	20		20	20	μA	$V_{REF} = V_{DD} = 3.6\text{ V}$ (per DAC channel)
Reference Input Range	0		V_{DD}	0		V_{DD}	V	
Reference Input Impedance		14.6			14.6		kΩ	Per DAC channel
REFERENCE OUTPUT								
Output Voltage AD5678-1	1.247		1.253	1.247		1.253	V	At ambient
Reference TC ³		±5	±15		±5	±15	ppm/°C	
Reference Output Impedance		7.5			7.5		kΩ	

AD5678

Parameter	A Grade ¹			B Grade ¹			Unit	Conditions/Comments
	Min	Typ	Max	Min	Typ	Max		
LOGIC INPUTS³								
Input Current			±3			±3	μA	All digital inputs V _{DD} = 3 V V _{DD} = 3 V
Input Low Voltage, V _{INL}			0.8			0.8	V	
Input High Voltage, V _{INH}	2			2			V	
Pin Capacitance		3			3		pF	
POWER REQUIREMENTS								
V _{DD}	2.7		3.6	2.7		3.6	V	All digital inputs at 0 or V _{DD} , DAC active, excludes load current V _{IH} = V _{DD} and V _{IL} = GND
I _{DD} (Normal Mode) ⁴								
V _{DD} = 2.7 V to 3.6 V		1.2	1.5		1.2	1.5	mA	Internal reference off
V _{DD} = 2.7 V to 3.6 V		1.7	2.25		1.7	2.25	mA	Internal reference on
I _{DD} (All Power-Down Modes) ⁵								V _{IH} = V _{DD} and V _{IL} = GND
V _{DD} = 2.7 V to 3.6 V		0.2	1		0.2	1	μA	

¹ Temperature range is -40°C to +105°C, typical at 25°C.

² Linearity calculated using a reduced code range of AD5678 12-bit DACs (Code 32 to Code 4,064) and AD5678 16-bit DACs (Code 512 to Code 65,024). Output unloaded.

³ Guaranteed by design and characterization; not production tested.

⁴ Interface inactive. All DACs active. DAC outputs unloaded.

⁵ All eight DACs powered down.

AC CHARACTERISTICS

$V_{DD} = 2.7\text{ V to }5.5\text{ V}$, $R_L = 2\text{ k}\Omega$ to GND, $C_L = 200\text{ pF}$ to GND, $V_{REFIN} = V_{DD}$. All specifications T_{MIN} to T_{MAX} , unless otherwise noted.

Table 3.

Parameter ^{1,2}	Min	Typ	Max	Unit	Conditions/Comments ³
Output Voltage Settling Time		6	10	μs	$\frac{1}{4}$ to $\frac{3}{4}$ scale settling to ± 2 LSB
Slew Rate		1.5		$\text{V}/\mu\text{s}$	
Digital-to-Analog Glitch Impulse		4		$\text{nV}\cdot\text{s}$	1 LSB change around major carry (see Figure 34)
Digital Feedthrough		0.1		$\text{nV}\cdot\text{s}$	
Reference Feedthrough		-90		dB	$V_{REF} = 2\text{ V} \pm 0.1\text{ V p-p}$, frequency = 10 Hz to 20 MHz
Digital Crosstalk		0.5		$\text{nV}\cdot\text{s}$	
Analog Crosstalk		2.5		$\text{nV}\cdot\text{s}$	
DAC-to-DAC Crosstalk		3		$\text{nV}\cdot\text{s}$	
Multiplying Bandwidth		340		kHz	$V_{REF} = 2\text{ V} \pm 0.2\text{ V p-p}$
Total Harmonic Distortion		-80		dB	$V_{REF} = 2\text{ V} \pm 0.1\text{ V p-p}$, frequency = 10 kHz
Output Noise Spectral Density		120		$\text{nV}/\sqrt{\text{Hz}}$	DAC code = 0x8400, 1 kHz
		100		$\text{nV}/\sqrt{\text{Hz}}$	DAC code = 0x8400, 10 kHz
Output Noise		15		$\mu\text{V p-p}$	0.1 Hz to 10 Hz

¹ Guaranteed by design and characterization; not production tested.

² See the Terminology section.

³ Temperature range is -40°C to $+105^\circ\text{C}$, typical at 25°C .

TIMING CHARACTERISTICS

All input signals are specified with $t_r = t_f = 1 \text{ ns/V}$ (10% to 90% of V_{DD}) and timed from a voltage level of $(V_{IL} + V_{IH})/2$. See Figure 2. $V_{DD} = 2.7 \text{ V}$ to 5.5 V . All specifications T_{MIN} to T_{MAX} , unless otherwise noted.

Table 4.

Parameter	Limit at T_{MIN} , T_{MAX} $V_{DD} = 2.7 \text{ V}$ to 5.5 V	Unit	Conditions/Comments
t_1^1	20	ns min	SCLK cycle time
t_2	8	ns min	SCLK high time
t_3	8	ns min	SCLK low time
t_4	13	ns min	$\overline{\text{SYNC}}$ to SCLK falling edge set-up time
t_5	4	ns min	Data set-up time
t_6	4	ns min	Data hold time
t_7	0	ns min	SCLK falling edge to $\overline{\text{SYNC}}$ rising edge
t_8	15	ns min	Minimum $\overline{\text{SYNC}}$ high time
t_9	13	ns min	$\overline{\text{SYNC}}$ rising edge to SCLK fall ignore
t_{10}	0	ns min	SCLK falling edge to $\overline{\text{SYNC}}$ fall ignore
t_{11}	10	ns min	$\overline{\text{LDAC}}$ pulse width low
t_{12}	15	ns min	SCLK falling edge to $\overline{\text{LDAC}}$ rising edge
t_{13}	5	ns min	$\overline{\text{CLR}}$ pulse width low
t_{14}	0	ns min	SCLK falling edge to $\overline{\text{LDAC}}$ falling edge
t_{15}	300	ns typ	$\overline{\text{CLR}}$ pulse activation time

¹ Maximum SCLK frequency is 50 MHz at $V_{DD} = 2.7 \text{ V}$ to 5.5 V . Guaranteed by design and characterization; not production tested.

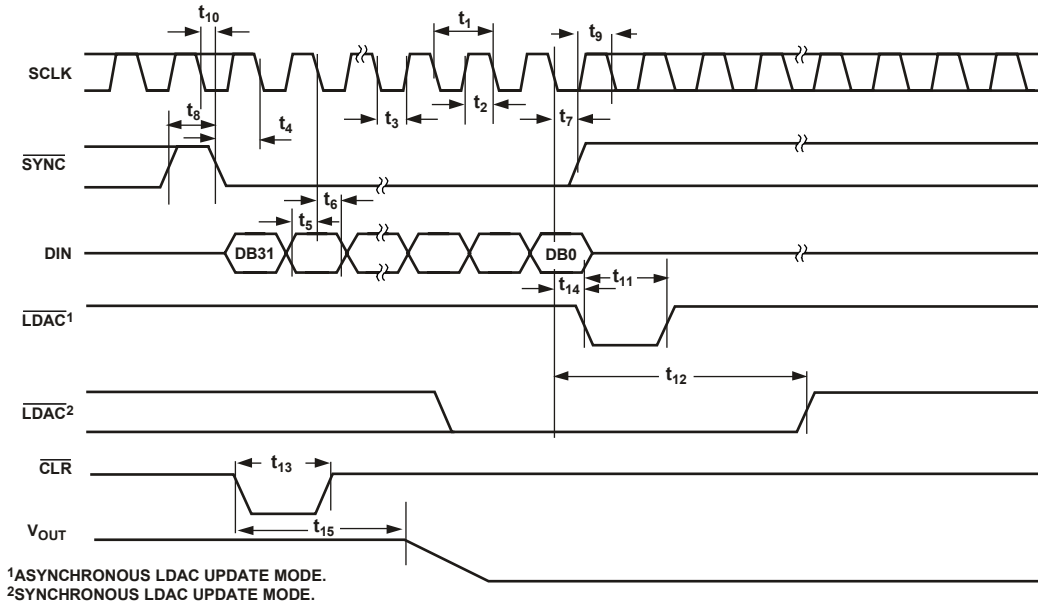

Figure 2. Serial Write Operation

ABSOLUTE MAXIMUM RATINGS

$T_A = 25^\circ\text{C}$, unless otherwise noted.

Table 5.

Parameter	Rating
V_{DD} to GND	-0.3 V to +7 V
Digital Input Voltage to GND	-0.3 V to $V_{DD} + 0.3$ V
V_{REFIN}/V_{REFOUT} to GND	-0.3 V to $V_{DD} + 0.3$ V
Operating Temperature Range	
Industrial (B Version)	-40°C to +105°C
Storage Temperature Range	-65°C to +150°C
Junction Temperature ($T_{J\text{ MAX}}$)	+150°C
TSSOP Package	
Power Dissipation	$(T_{J\text{ MAX}} - T_A)/\theta_{JA}$
θ_{JA} Thermal Impedance	150.4°C/W
Lead Temperature, Soldering	
SnPb	240°C
Pb Free	260°C

Stresses above those listed under Absolute Maximum Ratings may cause permanent damage to the device. This is a stress rating only; functional operation of the device at these or any other conditions above those indicated in the operational section of this specification is not implied. Exposure to absolute maximum rating conditions for extended periods may affect device reliability.

ESD CAUTION

ESD (electrostatic discharge) sensitive device. Electrostatic charges as high as 4000 V readily accumulate on the human body and test equipment and can discharge without detection. Although this product features proprietary ESD protection circuitry, permanent damage may occur on devices subjected to high energy electrostatic discharges. Therefore, proper ESD precautions are recommended to avoid performance degradation or loss of functionality.



PIN CONFIGURATION AND FUNCTION DESCRIPTIONS

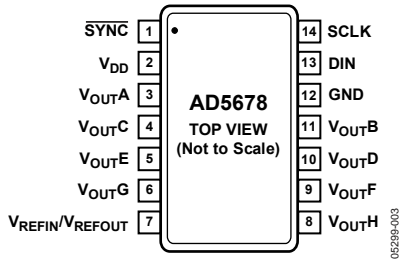

Figure 3. 14-Lead TSSOP (RU-14)

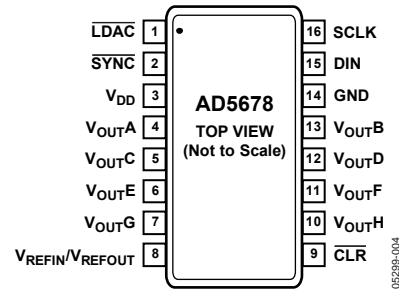

Figure 4. 16-Lead TSSOP (RU-16)

Table 6. Pin Function Descriptions

Pin No.		Mnemonic	Description
14-Lead TSSOP	16-Lead TSSOP		
–	1	$\overline{\text{LDAC}}$	Pulsing this pin low allows any or all DAC registers to be updated if the input registers have new data. This allows all DAC outputs to simultaneously update. Alternatively, this pin can be tied permanently low.
1	2	$\overline{\text{SYNC}}$	Active Low Control Input. This is the frame synchronization signal for the input data. When $\overline{\text{SYNC}}$ goes low, it powers on the SCLK and DIN buffers and enables the input shift register. Data is transferred in on the falling edges of the next 32 clocks. If $\overline{\text{SYNC}}$ is taken high before the 32 nd falling edge, the rising edge of $\overline{\text{SYNC}}$ acts as an interrupt and the write sequence is ignored by the device.
2	3	V_{DD}	Power Supply Input. These parts can be operated from 2.7 V to 5.5 V, and the supply should be decoupled with a 10 μF capacitor in parallel with a 0.1 μF capacitor to GND.
3	4	V_{OUTA}	Analog Output Voltage from DAC A. The output amplifier has rail-to-rail operation.
11	13	V_{OUTB}	Analog Output Voltage from DAC B. The output amplifier has rail-to-rail operation.
4	5	V_{OUTC}	Analog Output Voltage from DAC C. The output amplifier has rail-to-rail operation.
10	12	V_{OUTD}	Analog Output Voltage from DAC D. The output amplifier has rail-to-rail operation.
7	8	$V_{\text{REFIN}}/V_{\text{REFOUT}}$	The AD5678 has a common pin for reference input and reference output. When using the internal reference, this is the reference output pin. When using an external reference, this is the reference input pin. The default for this pin is as a reference input.
–	9	$\overline{\text{CLR}}$	Asynchronous Clear Input. The $\overline{\text{CLR}}$ input is falling edge sensitive. When $\overline{\text{CLR}}$ is low, all $\overline{\text{LDAC}}$ pulses are ignored. When $\overline{\text{CLR}}$ is activated, the input register and the DAC register are updated with the data contained in the $\overline{\text{CLR}}$ code register—zero, midscale, or full scale. Default setting clears the output to 0 V.
5	6	V_{OUTE}	Analog Output Voltage from DAC E. The output amplifier has rail-to-rail operation.
9	11	V_{OUTF}	Analog Output Voltage from DAC F. The output amplifier has rail-to-rail operation.
6	7	V_{OUTG}	Analog Output Voltage from DAC G. The output amplifier has rail-to-rail operation.
8	10	V_{OUTH}	Analog Output Voltage from DAC H. The output amplifier has rail-to-rail operation.
12	14	GND	Ground Reference Point for All Circuitry on the Part.
13	15	DIN	Serial Data Input. This device has a 32-bit shift register. Data is clocked into the register on the falling edge of the serial clock input.
14	16	SCLK	Serial Clock Input. Data is clocked into the input shift register on the falling edge of the serial clock input. Data can be transferred at rates of up to 50 MHz.

TYPICAL PERFORMANCE CHARACTERISTICS

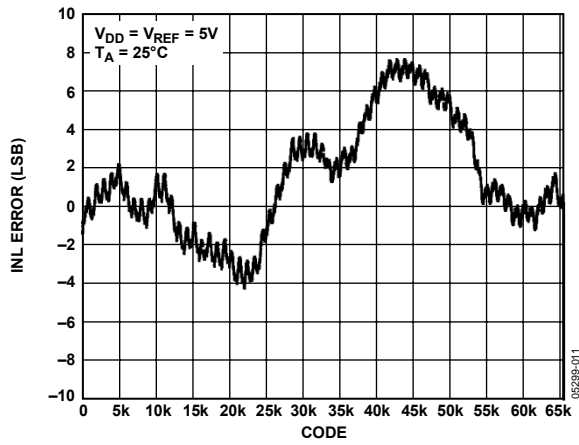

Figure 5. INL—16-Bit DAC

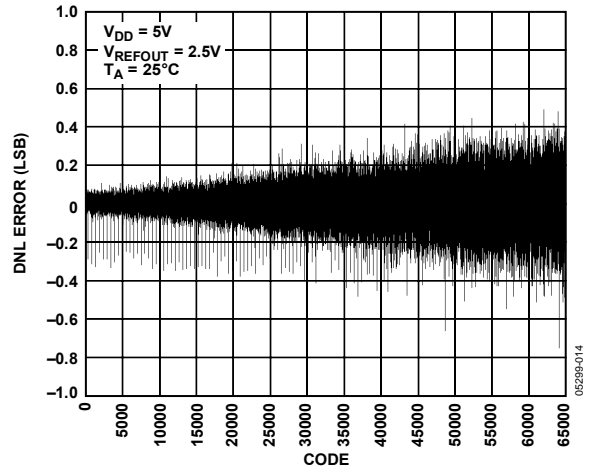

Figure 8. DNL 16-Bit DAC, 2.5 V Internal Reference

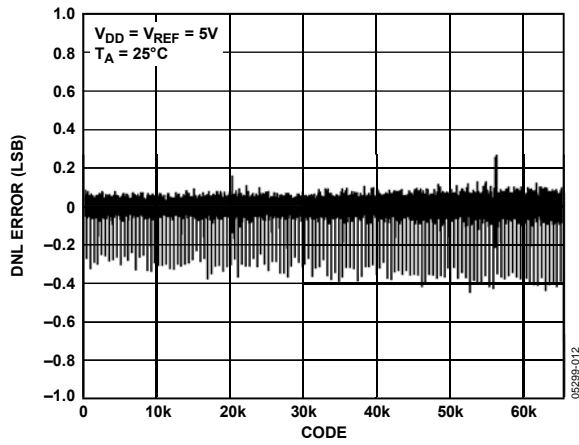

Figure 6. DNL—16-Bit DAC

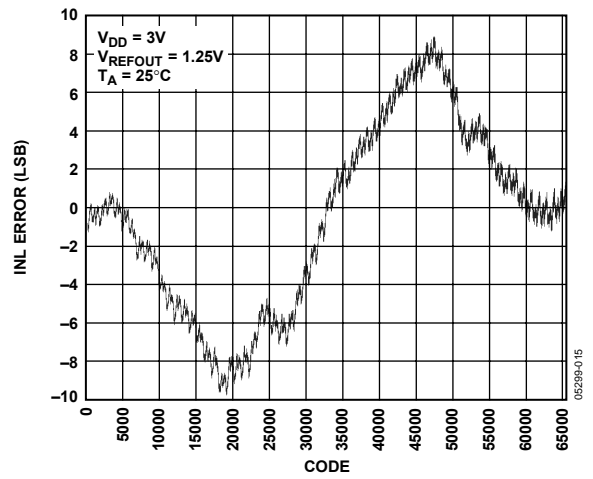

Figure 9. INL—16-Bit DAC, 1.25 V Internal Reference

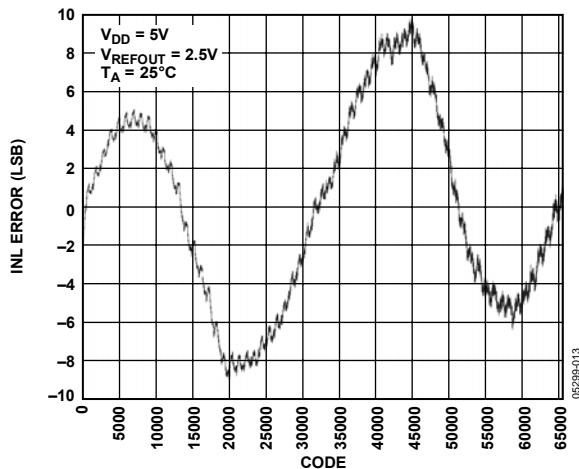

Figure 7. INL—16-Bit DAC, 2.5 V Internal Reference

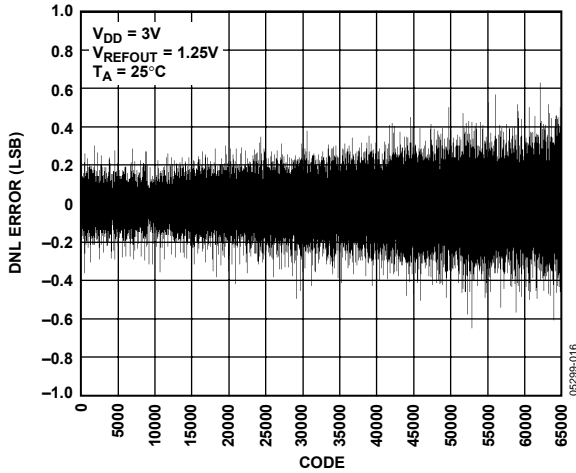

Figure 10. DNL—16-Bit DAC, 1.25 V Internal Reference

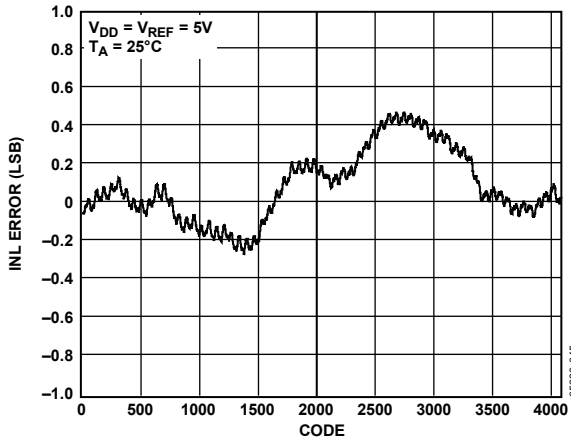

Figure 11. INL—12-Bit DAC

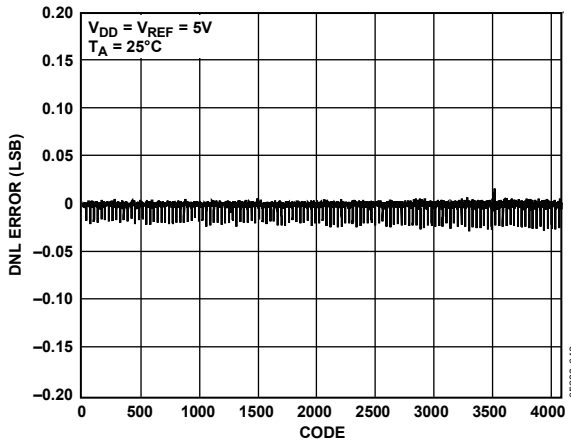

Figure 12. DNL—12-Bit DAC

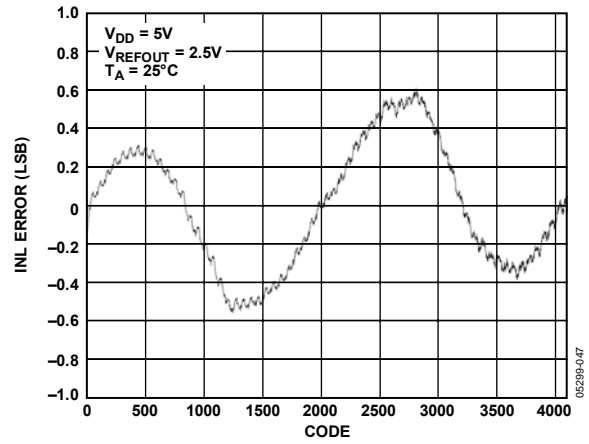

Figure 13. INL—12-Bit DAC, 2.5 V Internal Reference

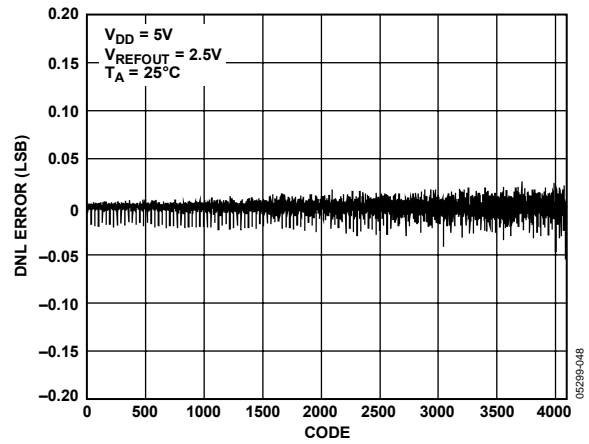

Figure 14. DNL 12-Bit DAC, 2.5 V Internal Reference

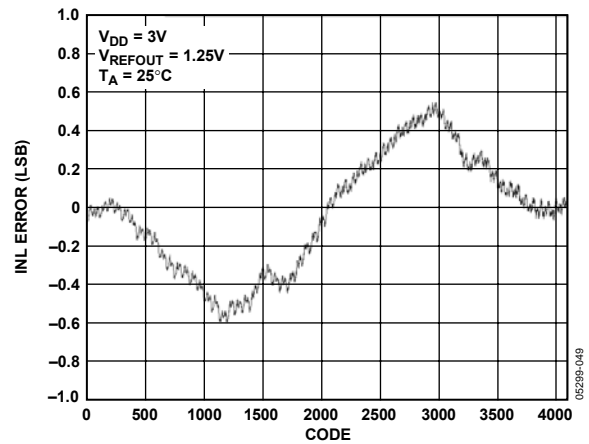

Figure 15. INL—12-Bit DAC, 1.25 V Internal Reference

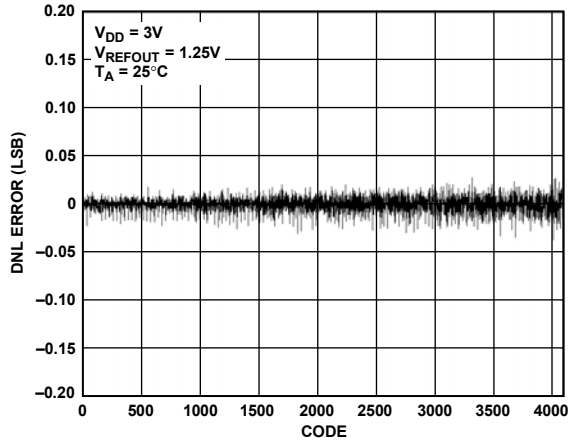

Figure 16. DNL—12-Bit DAC, 1.25 V Internal Reference

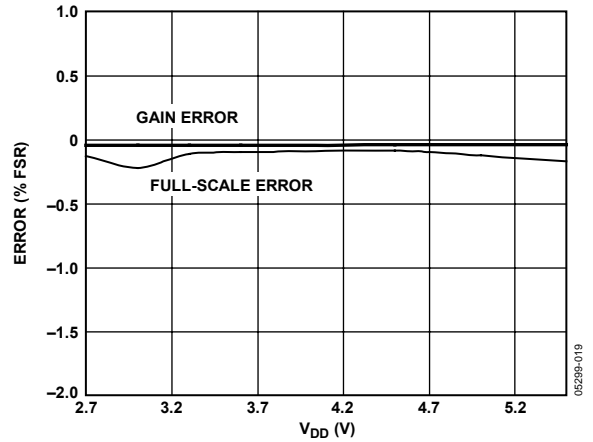

Figure 19. Gain Error and Full-Scale Error vs. Supply Voltage

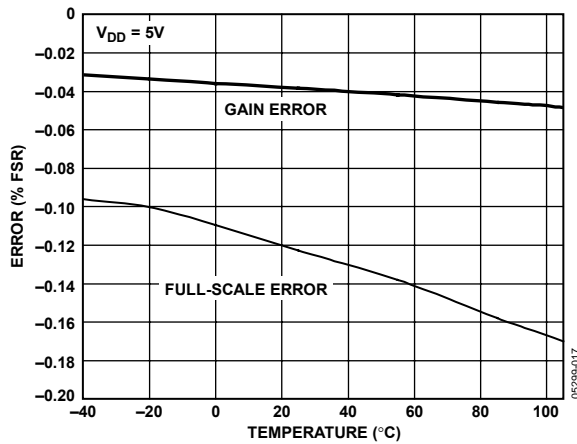

Figure 17. Gain Error and Full-Scale Error vs. Temperature

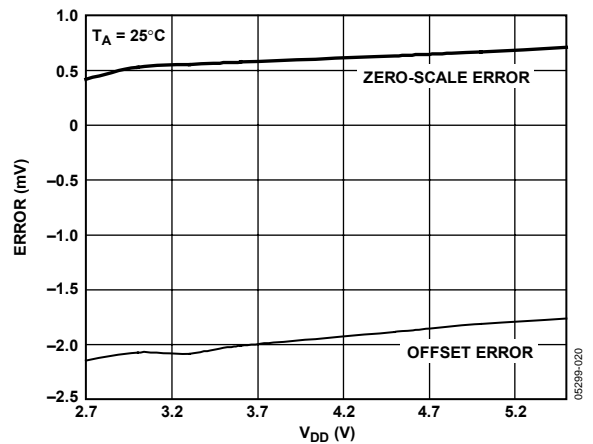

Figure 20. Zero-Scale Error and Offset Error vs. Supply Voltage

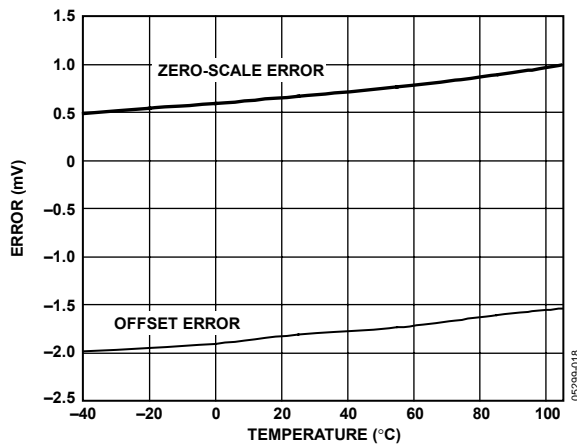

Figure 18. Zero-Scale Error and Offset Error vs. Temperature

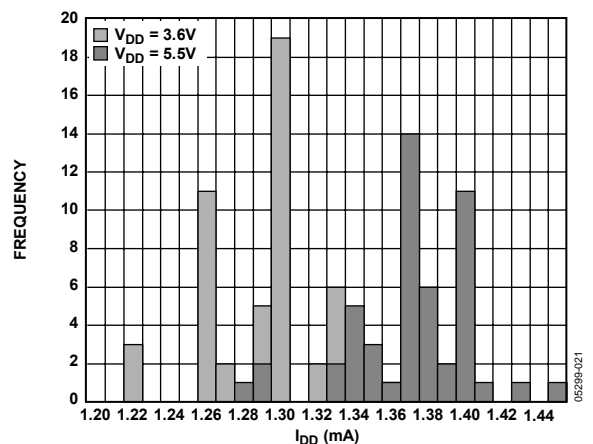

Figure 21. I_{DD} Histogram with External Reference

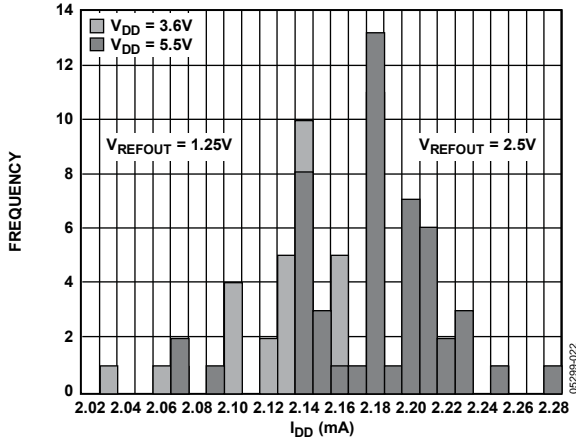

Figure 22. I_{DD} Histogram with Internal Reference

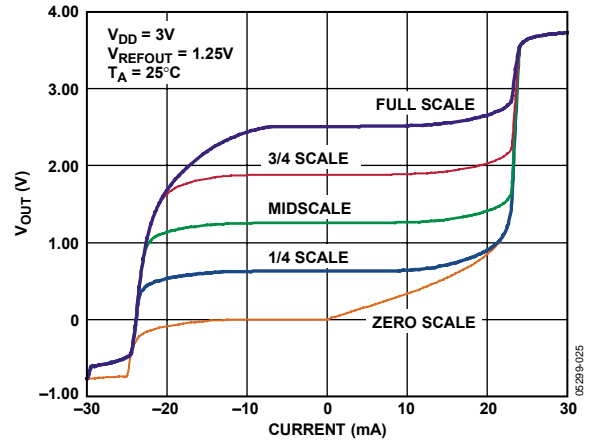

Figure 25. AD5678-1 Source and Sink Capability

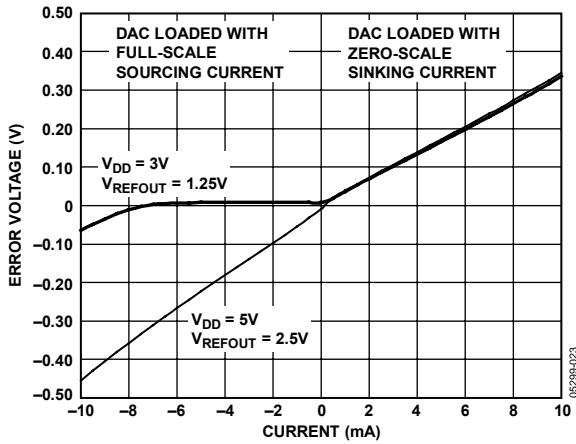

Figure 23. Headroom at Rails vs. Source and Sink

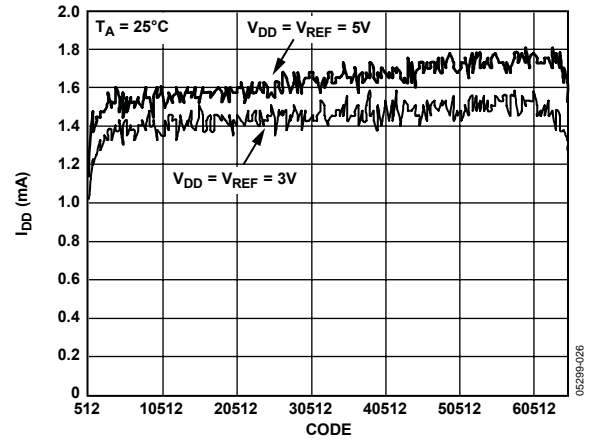

Figure 26. Supply Current vs. Code

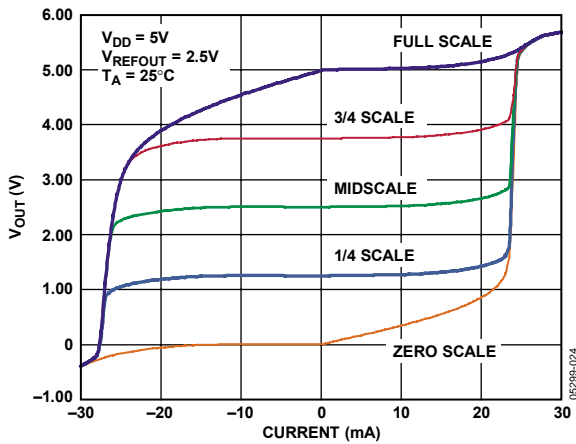

Figure 24. AD5678-2 Source and Sink Capability

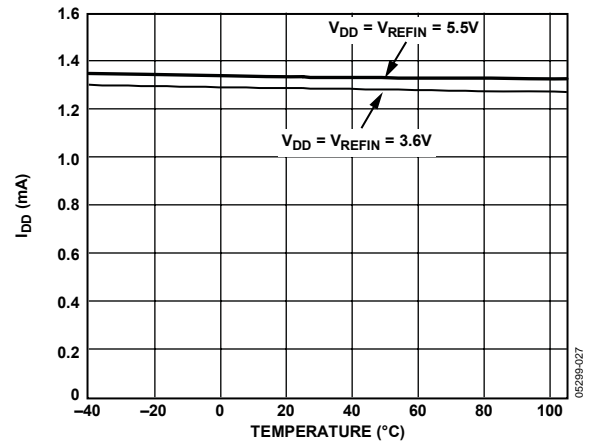

Figure 27. Supply Current vs. Temperature

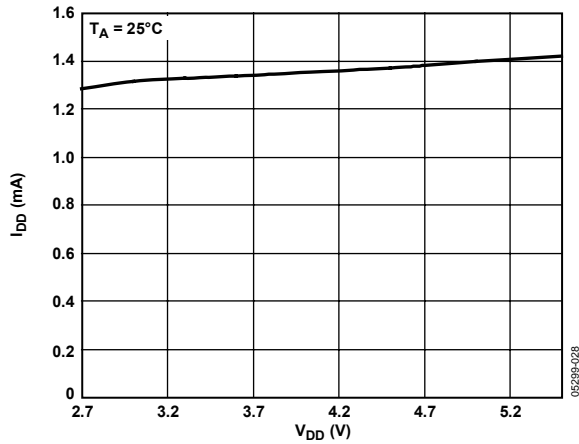

Figure 28. Supply Current vs. Supply Voltage

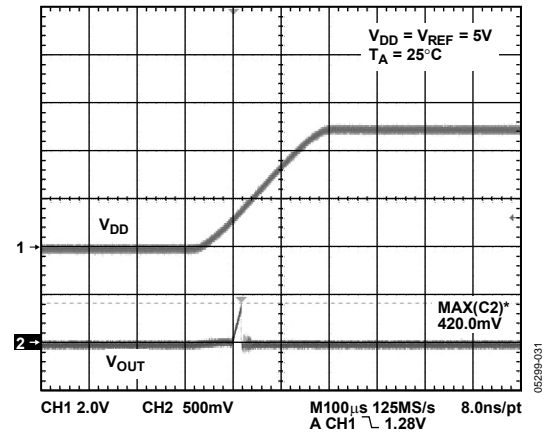

Figure 31. Power-On Reset to 0 V

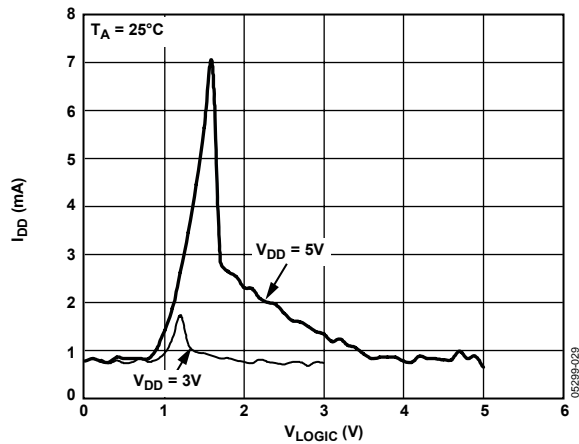

Figure 29. Supply Current vs. Logic Input Voltage

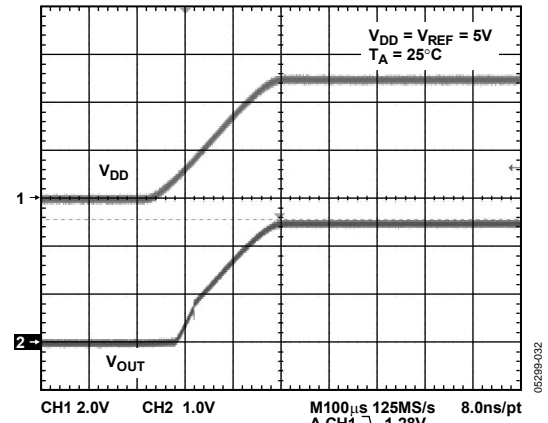

Figure 32. Power-On Reset to Midscale

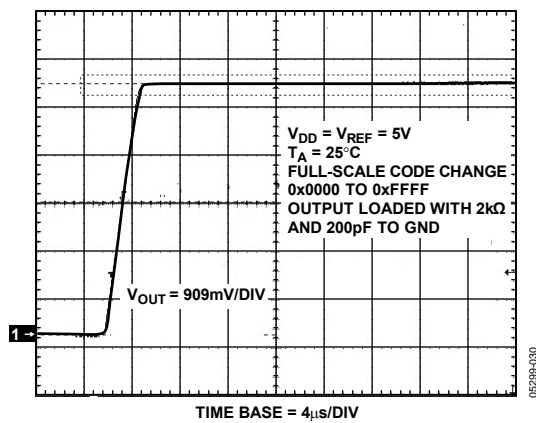

Figure 30. Full-Scale Settling Time, 5 V

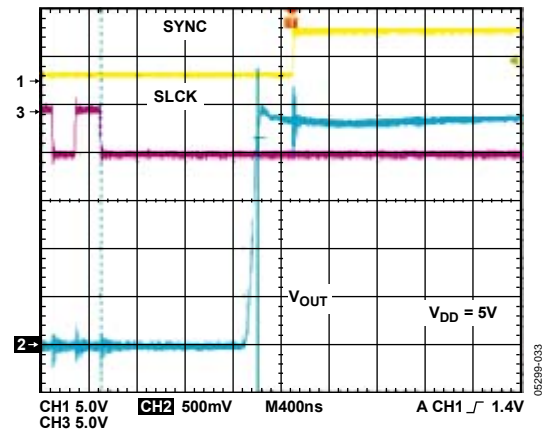

Figure 33. Exiting Power-Down to Midscale

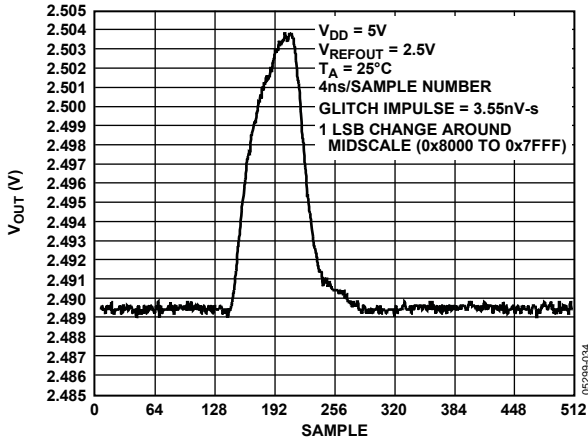

Figure 34. Digital-to-Analog Glitch Impulse (Negative)

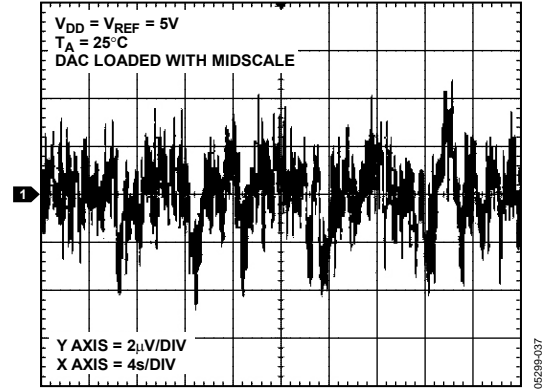

Figure 37. 0.1 Hz to 10 Hz Output Noise Plot, External Reference

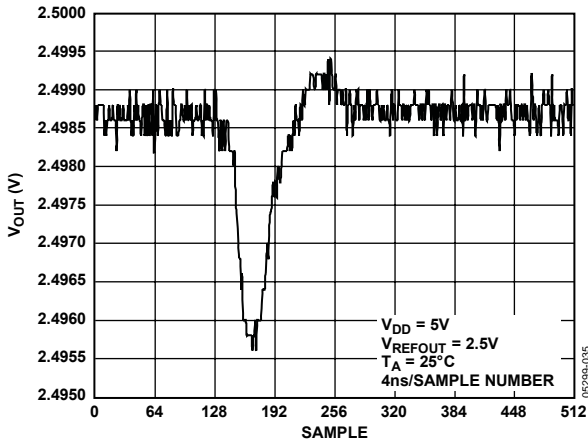

Figure 35. Analog Crosstalk

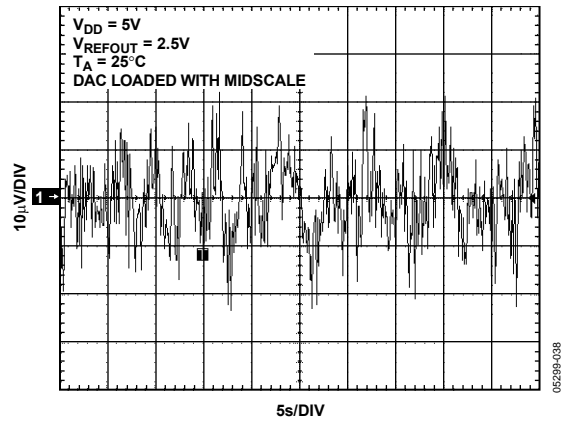

Figure 38. 0.1 Hz to 10 Hz Output Noise Plot, Internal Reference

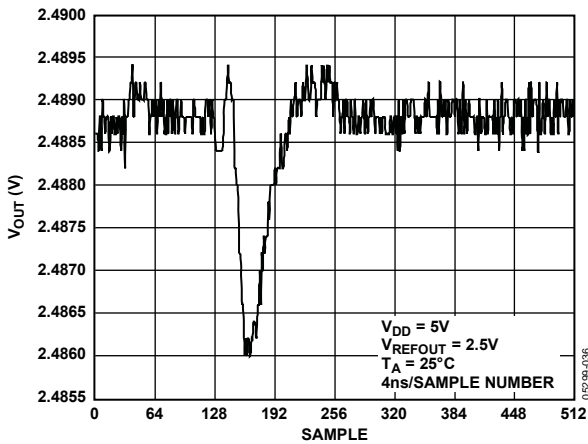

Figure 36. DAC-to-DAC Crosstalk

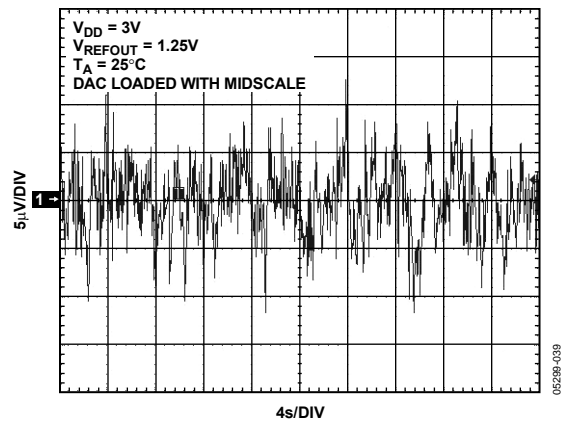

Figure 39. 0.1 Hz to 10 Hz Output Noise Plot, Internal Reference

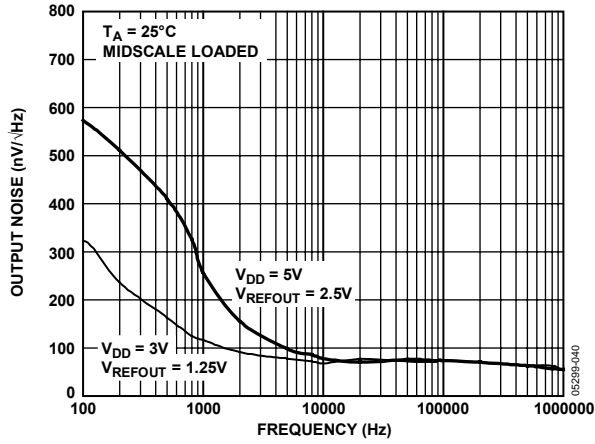

Figure 40. Noise Spectral Density, Internal Reference

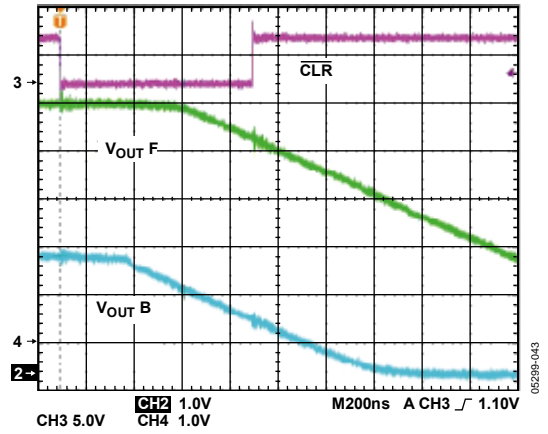

Figure 43. Hardware \overline{CLR}

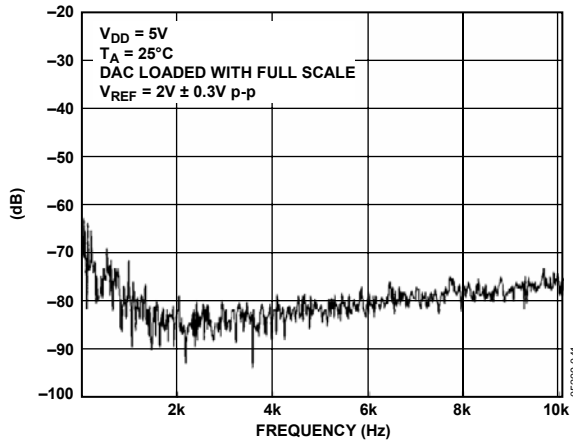

Figure 41. Total Harmonic Distortion

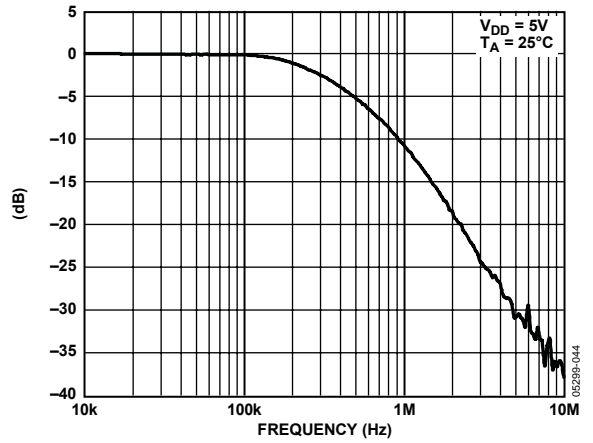

Figure 44. Multiplying Bandwidth

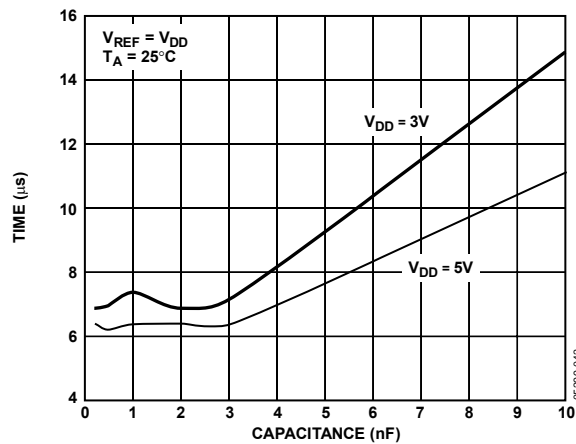

Figure 42. Settling Time vs. Capacitive Load

TERMINOLOGY

Relative Accuracy

For the DAC, relative accuracy, or integral nonlinearity (INL), is a measure of the maximum deviation in LSBs from a straight line passing through the endpoints of the DAC transfer function. Figure 5, Figure 7, and Figure 9 show plots of typical INL vs. code.

Differential Nonlinearity

Differential nonlinearity (DNL) is the difference between the measured change and the ideal 1 LSB change between any two adjacent codes. A specified differential nonlinearity of ± 1 LSB maximum ensures monotonicity. This DAC is guaranteed monotonic by design. Figure 6, Figure 8, and Figure 10 show plots of typical DNL vs. code.

Offset Error

Offset error is a measure of the difference between the actual V_{OUT} and the ideal V_{OUT} , expressed in millivolts in the linear region of the transfer function. Offset error is measured on the AD5678 with Code 512 loaded into the DAC register. It can be negative or positive and is expressed in millivolts.

Zero-Code Error

Zero-code error is a measure of the output error when zero code (0x0000) is loaded into the DAC register. Ideally, the output should be 0 V. The zero-code error is always positive in the AD5678, because the output of the DAC cannot go below 0 V. It is due to a combination of the offset errors in the DAC and output amplifier. Zero-code error is expressed in millivolts. Figure 18 shows a plot of typical zero-code error vs. temperature.

Gain Error

Gain error is a measure of the span error of the DAC. It is the deviation in slope of the DAC transfer characteristic from the ideal, expressed as a percentage of the full-scale range.

Zero-Code Error Drift

Zero-code error drift is a measure of the change in zero-code error with a change in temperature. It is expressed in $\mu V/^{\circ}C$.

Gain Error Drift

Gain error drift is a measure of the change in gain error with changes in temperature. It is expressed in (ppm of full-scale range)/ $^{\circ}C$.

Full-Scale Error

Full-scale error is a measure of the output error when full-scale code (0xFFFF) is loaded into the DAC register. Ideally, the output should be $V_{DD} - 1$ LSB. Full-scale error is expressed as a percentage of the full-scale range. Figure 17 shows a plot of typical full-scale error vs. temperature.

Digital-to-Analog Glitch Impulse

Digital-to-analog glitch impulse is the impulse injected into the analog output when the input code in the DAC register changes state. It is normally specified as the area of the glitch in nV-s and is measured when the digital input code is changed by 1 LSB at the major carry transition (0x7FFF to 0x8000). See Figure 34.

DC Power Supply Rejection Ratio (PSRR)

PSRR indicates how the output of the DAC is affected by changes in the supply voltage. PSRR is the ratio of the change in V_{OUT} to a change in V_{DD} for full-scale output of the DAC. It is measured in decibels. V_{REF} is held at 2 V, and V_{DD} is varied $\pm 10\%$.

DC Crosstalk

DC crosstalk is the dc change in the output level of one DAC in response to a change in the output of another DAC. It is measured with a full-scale output change on one DAC (or soft power-down and power-up) while monitoring another DAC. It is expressed in microvolts.

DC crosstalk due to load current change is a measure of the impact that a change in load current on one DAC has to another DAC kept at midscale. It is expressed in microvolts per milliamp.

Reference Feedthrough

Reference feedthrough is the ratio of the amplitude of the signal at the DAC output to the reference input when the DAC output is not being updated (that is, \overline{LDAC} is high). It is expressed in decibels.

Channel-to-Channel Isolation

Channel-to-channel isolation is the ratio of the amplitude of the signal at the output of one DAC to a sine wave on the reference input of another DAC. It is measured in decibels.

Digital Feedthrough

Digital feedthrough is a measure of the impulse injected into the analog output of a DAC from the digital input pins of the device, but is measured when the DAC is not being written to (\overline{SYNC} held high). It is specified in nV-s and measured with a full-scale change on the digital input pins, that is, from all 0s to all 1s or vice versa.

Digital Crosstalk

Digital crosstalk is the glitch impulse transferred to the output of one DAC at midscale in response to a full-scale code change (all 0s to all 1s or vice versa) in the input register of another DAC. It is measured in standalone mode and is expressed in nV-s.

Analog Crosstalk

Analog crosstalk is the glitch impulse transferred to the output of one DAC due to a change in the output of another DAC. It is measured by loading one of the input registers with a full-scale code change (all 0s to all 1s or vice versa) while keeping $\overline{\text{LDAC}}$ high, and then pulsing $\overline{\text{LDAC}}$ low and monitoring the output of the DAC whose digital code has not changed. The area of the glitch is expressed in nV-s.

DAC-to-DAC Crosstalk

DAC-to-DAC crosstalk is the glitch impulse transferred to the output of one DAC due to a digital code change and subsequent output change of another DAC. This includes both digital and analog crosstalk. It is measured by loading one of the DACs with a full-scale code change (all 0s to all 1s or vice versa) with $\overline{\text{LDAC}}$ low and monitoring the output of another DAC. The energy of the glitch is expressed in nV-s.

Multiplying Bandwidth

The amplifiers within the DAC have a finite bandwidth. The multiplying bandwidth is a measure of this. A sine wave on the reference (with full-scale code loaded to the DAC) appears on the output. The multiplying bandwidth is the frequency at which the output amplitude falls to 3 dB below the input.

Total Harmonic Distortion (THD)

Total harmonic distortion is the difference between an ideal sine wave and its attenuated version using the DAC. The sine wave is used as the reference for the DAC, and the THD is a measure of the harmonics present on the DAC output. It is measured in decibels.

THEORY OF OPERATION

D/A SECTION

The AD5678 DAC is fabricated on a CMOS process. The architecture consists of a string of DACs followed by an output buffer amplifier. The parts include an internal 1.25 V/2.5 V, 5 ppm/°C reference with an internal gain of 2. Figure 45 shows a block diagram of the DAC architecture.

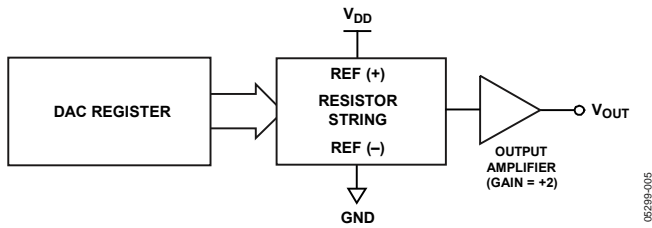

Figure 45. DAC Architecture

Because the input coding to the DAC is straight binary, the ideal output voltage when using an external reference is given by

$$V_{OUT} = V_{REFIN} \times \left(\frac{D}{2^N} \right)$$

the ideal output voltage when using an internal reference is given by

$$V_{OUT} = 2 \times V_{REFOUT} \times \left(\frac{D}{2^N} \right)$$

where:

D = decimal equivalent of the binary code that is loaded to the DAC register.

0 to 4,095 for AD5678 DAC C, D, E, F (12 bits).

0 to 65,535 for AD5678 DAC A, B, G, H (16 bits).

N = the DAC resolution.

RESISTOR STRING

The resistor string section is shown in Figure 46. It is simply a string of resistors, each of value R . The code loaded into the DAC register determines at which node on the string the voltage is tapped off to be fed into the output amplifier. The voltage is tapped off by closing one of the switches connecting the string to the amplifier. Because it is a string of resistors, it is guaranteed monotonic.

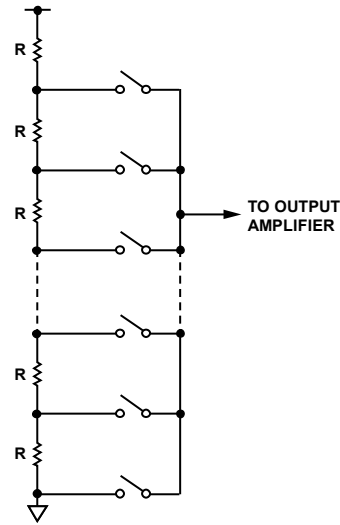

Figure 46. Resistor String

INTERNAL REFERENCE

The AD5678 has an on-chip reference with an internal gain of 2. The AD5678-1 has a 1.25 V 5 ppm/°C reference, giving a full-scale output of 2.5 V. The AD5678-2 has a 2.5 V 5 ppm/°C reference, giving a full-scale output of 5 V. The on-board reference is off at power-up, allowing the use of an external reference. The internal reference is enabled via a write to a control register. See Table 7.

The internal reference associated with each part is available at the V_{REFOUT} pin. A buffer is required if the reference output is used to drive external loads. When using the internal reference, it is recommended that a 100 nF capacitor be placed between the reference output and GND for reference stability.

Individual channel power-down is not supported while using the internal reference.

OUTPUT AMPLIFIER

The output buffer amplifier can generate rail-to-rail voltages on its output, which gives an output range of 0 V to V_{DD} . The amplifier is capable of driving a load of 2 k Ω in parallel with 1,000 pF to GND. The source and sink capabilities of the output amplifier can be seen in Figure 24 and Figure 25. The slew rate is 1.5 V/ μ s with a $\frac{1}{4}$ to $\frac{3}{4}$ scale settling time of 10 μ s.

SERIAL INTERFACE

The AD5678 has a 3-wire serial interface ($\overline{\text{SYNC}}$, SCLK, and DIN) that is compatible with SPI, QSPI, and MICROWIRE interface standards as well as most DSPs. See Figure 2 for a timing diagram of a typical write sequence.

The write sequence begins by bringing the $\overline{\text{SYNC}}$ line low. Data from the DIN line is clocked into the 32-bit shift register on the falling edge of SCLK. The serial clock frequency can be as high as 50 MHz, making the AD5678 compatible with high speed DSPs. On the 32nd falling clock edge, the last data bit is clocked in and the programmed function is executed, that is, a change in DAC register contents and/or a change in the mode of operation. At this stage, the $\overline{\text{SYNC}}$ line can be kept low or be brought high. In either case, it must be brought high for a minimum of 15 ns before the next write sequence so that a falling edge of $\overline{\text{SYNC}}$ can initiate the next write sequence. Because the $\overline{\text{SYNC}}$ buffer draws more current when $V_{IN} = 2$ V than it does when $V_{IN} = 0.8$ V, $\overline{\text{SYNC}}$ should be idled low between write sequences for even lower power operation of the part. As is mentioned previously, however, $\overline{\text{SYNC}}$ must be brought high again just before the next write sequence.

Table 7. Command Definitions

Command				Description
C3	C2	C1	C0	
0	0	0	0	Write to Input Register n
0	0	0	1	Update DAC Register n
0	0	1	0	Write to Input Register n, update all (software LDAC)
0	0	1	1	Write to and update DAC Channel n
0	1	0	0	Power down/power up DAC
0	1	0	1	Load clear code register
0	1	1	0	Load LDAC register
0	1	1	1	Reset (power-on reset)
1	0	0	0	Set up internal REF register
1	0	0	1	Reserved
–	–	–	–	Reserved
1	1	1	1	Reserved

Table 8. Address Commands

Address (n)				Selected DAC Channel
A3	A2	A1	A0	
0	0	0	0	DAC A (16 bits)
0	0	0	1	DAC B (16 bits)
0	0	1	0	DAC C (12 bits)
0	0	1	1	DAC D (12 bits)
0	1	0	0	DAC E (12 bits)
0	1	0	1	DAC F (12 bits)
0	1	1	0	DAC G (16 bits)
0	1	1	1	DAC H (16 bits)
1	1	1	1	All DACs

AD5678

INPUT SHIFT REGISTER

The input shift register is 32 bits wide. The first four bits are don't cares. The next four bits are the command bits, C3 to C0 (see Table 7), followed by the 4-bit DAC address bits, A3 to A0 (see Table 8), and finally the 16-/12-bit data-word. The data-word comprises the 16-/12-bit input code followed by four or eight don't care bits for the AD5678 DAC A, B, G, H and AD5678 DAC C, D, E, F, respectively (See Figure 47 and Figure 48). These data bits are transferred to the DAC register on the 32nd falling edge of SCLK.

SYNC INTERRUPT

In a normal write sequence, the $\overline{\text{SYNC}}$ line is kept low for 32 falling edges of SCLK, and the DAC is updated on the 32nd falling edge and rising edge of $\overline{\text{SYNC}}$. However, if $\overline{\text{SYNC}}$ is brought high before the 32nd falling edge, this acts as an interrupt to the write sequence. The shift register is reset, and the write sequence is seen as invalid. Neither an update of the DAC register contents nor a change in the operating mode occurs—see Figure 49.

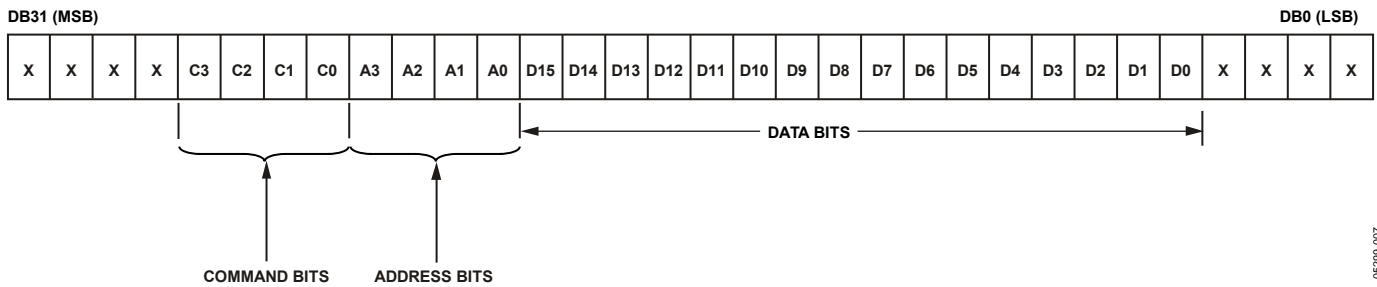

Figure 47. AD5678 Input Register Content for DAC A, B, G, H

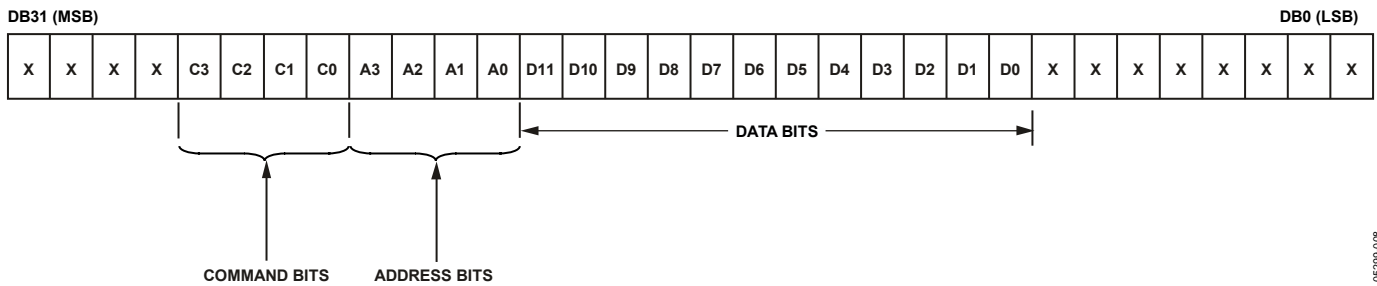

Figure 48. AD5678 Input Register Content for DAC C, D, E, F

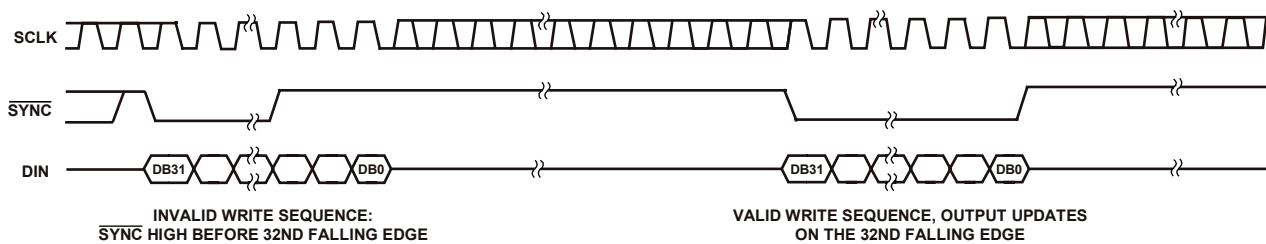

Figure 49. $\overline{\text{SYNC}}$ Interrupt Facility

INTERNAL REFERENCE REGISTER

The on-board reference is off at power-up by default. This allows the use of an external reference if the application requires it. The on-board reference can be turned on/off by a user-programmable internal REF register by setting Bit DB0 high or low (see Table 9). Command 1000 is reserved for this internal REF set-up command (see Table 7). Table 11 shows the state of the bits in the input shift register corresponds to the mode of operation of the device.

POWER-ON RESET

The AD5678 contains a power-on reset circuit that controls the output voltage during power-up. The AD5678 output powers up to 0 V, and the output remains powered up at this level until a valid write sequence is made to the DAC. This is useful in applications where it is important to know the state of the output of the DAC while it is in the process of powering up. There is also a software executable reset function that resets the DAC to the power-on reset code. Command 0111 is reserved for this reset function—see Table 7. Any events on $\overline{\text{LDAC}}$ or $\overline{\text{CLR}}$ during power-on reset are ignored.

POWER-DOWN MODES

The AD5678 contains four separate modes of operation. Command 0100 is reserved for the power-down function. See Table 7. These modes are software-programmable by setting two bits, Bit DB9 and Bit DB8, in the control register.

Table 11 shows how the state of the bits corresponds to the mode of operation of the device. Any or all DACs (DAC H to DAC A) can be powered down to the selected mode by setting the corresponding eight bits (DB7 to DB0) to 1. See Table 12 for the contents of the input shift register during power-down/power-up operation. When using the internal reference, only all channel power-down to the selected modes is supported.

When both bits are set to 0, the part works normally with its normal power consumption of 1.3 mA at 5 V. However, for the three power-down modes, the supply current falls to 400 nA at 5 V (200 nA at 3 V). Not only does the supply current fall, but the output stage is also internally switched from the output of the amplifier to a resistor network of known values. This has the advantage that the output impedance of the part is known while

the part is in power-down mode. There are three different options. The output is connected internally to GND through either a 1 k Ω or a 100 k Ω resistor, or it is left open-circuited (three-state). The output stage is illustrated in Figure 50.

The bias generator of the selected DAC(s), output amplifier, resistor string, and other associated linear circuitry are shut down when the power-down mode is activated. However, the contents of the DAC register are unaffected when in power-down. The time to exit power-down is typically 5 μs for $V_{\text{DD}} = 5 \text{ V}$ and for $V_{\text{DD}} = 3 \text{ V}$, see Figure 33.

Any combination of DACs can be powered up by setting PD1 and PD0 to 0 (normal operation). The output powers up to the value in the input register ($\overline{\text{LDAC}}$ low) or to the value in the DAC register before powering down ($\overline{\text{LDAC}}$ high).

CLEAR CODE REGISTER

The AD5678 has a hardware $\overline{\text{CLR}}$ pin that is an asynchronous clear input. The $\overline{\text{CLR}}$ input is falling edge sensitive. Bringing the $\overline{\text{CLR}}$ line low clears the contents of the input register and the DAC registers to the data contained in the user-configurable $\overline{\text{CLR}}$ register and sets the analog outputs accordingly. This function can be used in system calibration to load zero scale, midscale, or full scale to all channels together. These clear code values are user-programmable by setting two bits, Bit DB1 and Bit DB0, in the $\overline{\text{CLR}}$ control register. See Table 13. The default setting clears the outputs to 0 V. Command 0101 is reserved for loading the clear code register, see Table 7.

The part exits clear code mode on the 32nd falling edge of the next write to the part. If $\overline{\text{CLR}}$ is activated during a write sequence, the write is aborted.

The $\overline{\text{CLR}}$ pulse activation time—the falling edge of $\overline{\text{CLR}}$ to when the output starts to change—is typically 280 ns. However, if the value is outside the linear region, it typically takes 520 ns after executing $\overline{\text{CLR}}$ for the output to start changing. See Figure 43.

See Table 14 for contents of the input shift register during the loading clear code register operation.

AD5678

Table 9. Internal Reference Register

Internal REF Register (DB0)	Action
0	Reference off (default)
1	Reference on

Table 10. 32-Bit Input Shift Register Contents for Reference Set-Up Function

MSB										LSB	
DB31 to DB28	DB27	DB26	DB25	DB24	DB23	DB22	DB21	DB20	DB19 to DB1	DB0	
X	1	0	0	0	X	X	X	X	X	1/0	
Don't cares	Command bits (C3 to C0)				Address bits (A3 to A0)				Don't cares	Internal REF register	

Table 11. Power-Down Modes of Operation

DB9	DB8	Operating Mode
0	0	Normal operation
0	1	Power-down modes
1	0	1 kΩ to GND
1	1	100 kΩ to GND
1	1	Three-state

Table 12. 32-Bit Input Shift Register Contents for Power-Down/Power-Up Function

MSB																			LSB	
DB31 to DB28	DB27	DB26	DB25	DB24	DB23	DB22	DB21	DB20	DB19 to DB10	DB9	DB8	DB7	DB6	DB5	DB4	DB3	DB2	DB1	DB0	
X	0	1	0	0	X	X	X	X	X	PD1	PD0	DAC H	DAC G	DAC F	DAC E	DAC D	DAC C	DAC B	DAC A	
Don't cares	Command bits (C3 to C0)				Address bits (A3 to A0)—don't cares				Don't cares	Power-down mode	Power-down/power-up channel selection—set bit to 1 to select									

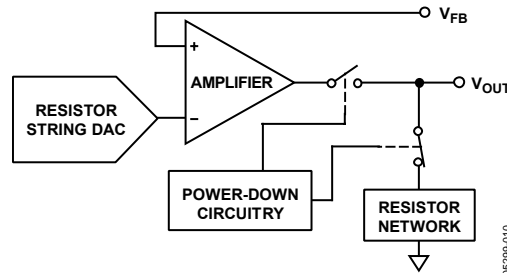

Figure 50. Output Stage During Power-Down

Table 13. Clear Code Register

Clear Code Register		Clears to Code
DB1	DB0	
CR1	CR0	
0	0	0x0000
0	1	0x8000
1	0	0xFFFF
1	1	No operation

Table 14. 32-Bit Input Shift Register Contents for Clear Code Function

MSB										LSB	
DB31 to DB28	DB27	DB26	DB25	DB24	DB23	DB22	DB21	DB20	DB19 to DB2	DB1	DB0
X	0	1	0	1	X	X	X	X	X	CR1	CR0
Don't cares	Command bits (C3 to C0)				Address bits (A3 to A0)—don't cares				Don't cares	Clear code register	

LDAC FUNCTION

The outputs of all DACs can be updated simultaneously using the hardware $\overline{\text{LDAC}}$ pin.

Synchronous $\overline{\text{LDAC}}$: After new data is read, the DAC registers are updated on the falling edge of the 32nd SCLK pulse. $\overline{\text{LDAC}}$ can be permanently low or pulsed as in Figure 2.

Asynchronous $\overline{\text{LDAC}}$: The outputs are not updated at the same time that the input registers are written to. When $\overline{\text{LDAC}}$ goes low, the DAC registers are updated with the contents of the input register.

Alternatively, the outputs of all DACs can be updated simultaneously using the software $\overline{\text{LDAC}}$ function by writing to Input Register n and updating all DAC registers. Command 0011 is reserved for this software LDAC function.

An $\overline{\text{LDAC}}$ register gives the user extra flexibility and control over the hardware $\overline{\text{LDAC}}$ pin. This register allows the user to select which combination of channels to simultaneously update when the hardware $\overline{\text{LDAC}}$ pin is executed. Setting the $\overline{\text{LDAC}}$ bit register to 0 for a DAC channel means that this channel's update is controlled by the $\overline{\text{LDAC}}$ pin. If this bit is set to 1, this channel updates synchronously; that is, the DAC register is updated after new data is read, regardless of the state of the $\overline{\text{LDAC}}$ pin. It effectively sees the $\overline{\text{LDAC}}$ pin as being tied low. (See Table 15 for the $\overline{\text{LDAC}}$ register mode of operation.) This flexibility is useful in applications where the user wants to simultaneously update select channels while the rest of the channels are synchronously updating.

Writing to the DAC using command 0110 loads the 8-bit $\overline{\text{LDAC}}$ register (DB7 to DB0). The default for each channel is 0; that is, the $\overline{\text{LDAC}}$ pin works normally. Setting the bits to 1 means the DAC channel is updated regardless of the state of the $\overline{\text{LDAC}}$

pin. See Table 16 for the contents of the input shift register during the load $\overline{\text{LDAC}}$ register mode of operation.

POWER SUPPLY BYPASSING AND GROUNDING

When accuracy is important in a circuit, it is helpful to carefully consider the power supply and ground return layout on the board. The printed circuit board containing the AD5678 should have separate analog and digital sections. If the AD5678 is in a system where other devices require an AGND-to-DGND connection, the connection should be made at one point only. This ground point should be as close as possible to the AD5678.

The power supply to the AD5678 should be bypassed with 10 μF and 0.1 μF capacitors. The capacitors should physically be as close as possible to the device, with the 0.1 μF capacitor ideally right up against the device. The 10 μF capacitors are the tantalum bead type. It is important that the 0.1 μF capacitor has low effective series resistance (ESR) and low effective series inductance (ESI), such as is typical of common ceramic types of capacitors. This 0.1 μF capacitor provides a low impedance path to ground for high frequencies caused by transient currents due to internal logic switching.

The power supply line should have as large a trace as possible to provide a low impedance path and reduce glitch effects on the supply line. Clocks and other fast switching digital signals should be shielded from other parts of the board by digital ground. Avoid crossover of digital and analog signals if possible. When traces cross on opposite sides of the board, ensure that they run at right angles to each other to reduce feedthrough effects through the board. The best board layout technique is the microstrip technique, where the component side of the board is dedicated to the ground plane only and the signal traces are placed on the solder side. However, this is not always possible with a 2-layer board.

Table 15. $\overline{\text{LDAC}}$ Register

Load DAC Register		$\overline{\text{LDAC}}$ Operation
$\overline{\text{LDAC}}$ Bits (DB7 to DB0)	$\overline{\text{LDAC}}$ Pin	
0	1/0	Determined by $\overline{\text{LDAC}}$ pin
1	X—don't care	DAC channels update, overriding the $\overline{\text{LDAC}}$ pin. DAC channels see $\overline{\text{LDAC}}$ as 0.

Table 16. 32-Bit Input Shift Register Contents for $\overline{\text{LDAC}}$ Overwrite Function

MSB																	LSB
DB31 to DB28	DB27	DB26	DB25	DB24	DB23	DB22	DB21	DB20	DB19 to DB8	DB7	DB6	DB5	DB4	DB3	DB2	DB1	DB0
X	0	1	1	0	X	X	X	X	X	DAC H	DAC G	DAC F	DAC E	DAC D	DAC C	DAC B	DAC A
Don't cares	Command bits (C3 to C0)				Address bits (A3 to A0)—don't cares				Don't cares	Setting $\overline{\text{LDAC}}$ bit to 1 overrides $\overline{\text{LDAC}}$ pin							

OUTLINE DIMENSIONS

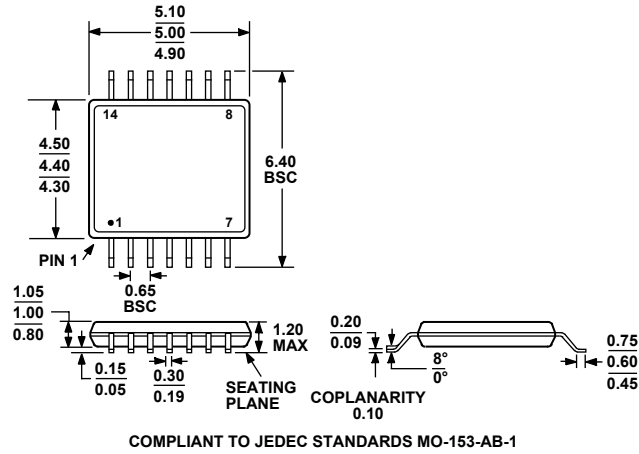

Figure 51. 14-Lead Thin Shrink Small Outline Package [TSSOP] (RU-14)
Dimensions shown in millimeters

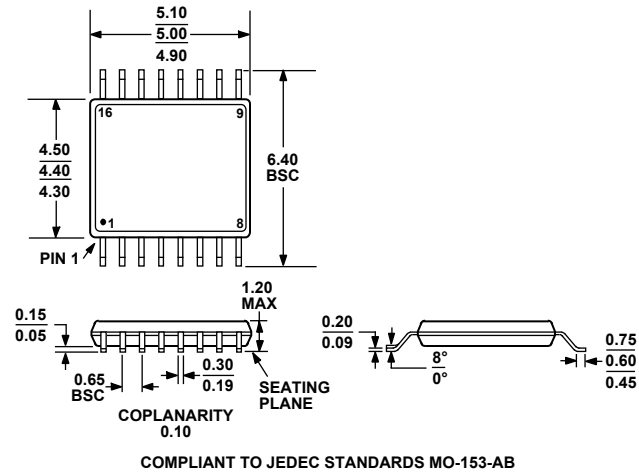

Figure 52. 16-Lead Thin Shrink Small Outline Package [TSSOP] (RU-16)
Dimensions shown in millimeters

ORDERING GUIDE

Model	Temperature Range	Package Description	Package Option	Power-On Reset to Code	Accuracy	Internal Reference
AD5678BRUZ-1 ¹	-40°C to +105°C	14-Lead TSSOP	RU-14	Zero	±16 LSB INL	1.25 V
AD5678BRUZ-1REEL7 ¹	-40°C to +105°C	14-Lead TSSOP	RU-14	Zero	±16 LSB INL	1.25 V
AD5678BRUZ-2 ¹	-40°C to +105°C	16-Lead TSSOP	RU-16	Zero	±16 LSB INL	2.5 V
AD5678BRUZ-2REEL7 ¹	-40°C to +105°C	16-Lead TSSOP	RU-16	Zero	±16 LSB INL	2.5 V
AD5678ARUZ-2 ¹	-40°C to +105°C	16-Lead TSSOP	RU-16	Zero	±32 LSB INL	2.5 V
AD5678ARUZ-2REEL7 ¹	-40°C to +105°C	16-Lead TSSOP	RU-16	Zero	±32 LSB INL	2.5 V

¹ Z = Pb-free part.

NOTES

AD5678

NOTES