

## CASCADABLE BROADBAND GaAs MMIC AMPLIFIER DC TO 12GHz

### Typical Applications

- Narrow and Broadband Commercial and Military Radio Designs
- Linear and Saturated Amplifiers
- Gain Stage or Driver Amplifiers for MWRadio/Optical Designs (PTP/PMP/LMDS/UNII/VSAT/WLAN/Cellular/DWDM)

### Product Description

The NBB-312 cascadable broadband InGaP/GaAs MMIC amplifier is a low-cost, high-performance solution for general purpose RF and microwave amplification needs. This 50Ω gain block is based on a reliable HBT proprietary MMIC design, providing unsurpassed performance for small-signal applications. Designed with an external bias resistor, the NBB-312 provides flexibility and stability. The NBB-310 is packaged in a low-cost, surface-mount ceramic package, providing ease of assembly for high-volume tape-and-reel requirements. It is available in either 1,000 or 3,000 piece-per-reel quantities. Connectorized evaluation board designs optimized for high frequency are also available for characterization purposes.

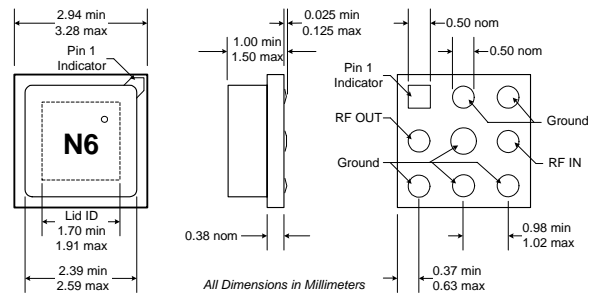

- Notes:  
 1. Solder pads are coplanar to within ±0.025 mm.  
 2. Lid will be centered relative to frontside metallization with a tolerance of ±0.13 mm.  
 3. Mark to include two characters and dot to reference pin 1.

### Optimum Technology Matching® Applied

- |   |                                   |                                       |
|---|-----------------------------------|---------------------------------------|
| <input type="checkbox"/> Si BJT               | <input type="checkbox"/> GaAs HBT | <input type="checkbox"/> GaAs MESFET  |
| <input type="checkbox"/> Si Bi-CMOS           | <input type="checkbox"/> SiGe HBT | <input type="checkbox"/> Si CMOS      |
| <input checked="" type="checkbox"/> InGaP/HBT | <input type="checkbox"/> GaN HEMT | <input type="checkbox"/> SiGe Bi-CMOS |

### Package Style: MPGA, Bowtie, 3x3, Ceramic

### Features

- Reliable, Low-Cost HBT Design
  - 12.5dB Gain
  - High P1dB of +15.8dBm at 6GHz
  - Single Power Supply Operation
  - 50Ω I/O Matched for High Frequency
- Use

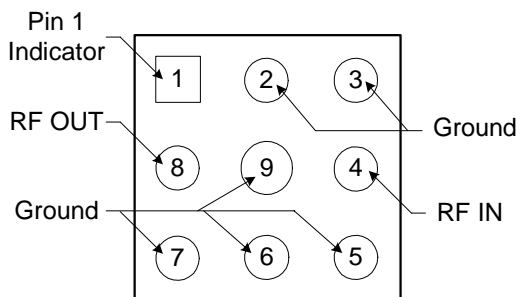

Functional Block Diagram

### Ordering Information

NBB-312	Cascadable Broadband GaAs MMIC Amplifier DC to 12GHz
NBB-312-T1 or -T3	Tape & Reel, 1000 or 3000 Pieces (respectively)
NBB-312-E	Fully Assembled Evaluation Board
NBB-X-K1	Extended Frequency InGaP Amp Designer's Tool Kit
RF Micro Devices, Inc.	Tel (336) 664 1233
7628 Thorndike Road	Fax (336) 664 0454
Greensboro, NC 27409, USA	http://www.rfmd.com

# NBB-312

## Absolute Maximum Ratings

Parameter	Rating	Unit
RF Input Power	+20	dBm
Power Dissipation	350	mW
Device Current	70	mA
Channel Temperature	200	°C
Operating Temperature	-45 to +85	°C
Storage Temperature	-65 to +150	°C

Exceeding any one or a combination of these limits may cause permanent damage.



**Caution!** ESD sensitive device.

RF Micro Devices believes the furnished information is correct and accurate at the time of this printing. However, RF Micro Devices reserves the right to make changes to its products without notice. RF Micro Devices does not assume responsibility for the use of the described product(s).

Parameter	Specification			Unit	Condition
	Min.	Typ.	Max.		
<b>Overall</b>					$V_D=+5V, I_{CC}=50mA, Z_0=50\Omega, T_A=+25^\circ C$
Small Signal Power Gain, S21	12.5	12.9		dB	f=0.1GHz to 1.0GHz
	12.0	12.9		dB	f=1.0GHz to 4.0GHz
	11.4	11.7		dB	f=4.0GHz to 8.0GHz
	9.0	9.7		dB	f=8.0GHz to 12.0GHz
Gain Flatness, GF		+0.6		dB	f=0.1GHz to 8.0GHz
Input VSWR		1.2:1			f=0.1GHz to 7.0GHz
		1.65:1			f=7.0GHz to 10.0GHz
Output VSWR		2.0:1			f=10.0GHz to 12.0GHz
Bandwidth, BW		11.0		GHz	f=0.1GHz to 12.0GHz
Output Power @ -1dB Compression, P1dB		14.9		dBm	BW3 (3dB)
		15.8		dBm	f=2.0GHz
		15.0		dBm	f=6.0GHz
		12.0		dBm	f=8.0GHz
Noise Figure, NF		4.9		dB	f=12.0GHz
Third Order Intercept, IP3		+24.0		dBm	f=3.0GHz
Reverse Isolation, S12		-15.6		dB	f=2.0GHz
Device Voltage, $V_D$	4.7	5.0	5.3	V	f=0.1GHz to 12.0GHz
Gain Temperature Coefficient, $\delta G_T/\delta T$		-0.0015		dB/°C	
<b>MTTF versus Temperature @ <math>I_{CC}=50mA</math></b>					
Case Temperature		85		°C	
Junction Temperature		123		°C	
MTTF		>1,000,000		hours	
<b>Thermal Resistance</b>					
$\theta_{JC}$		152		°C/W	$\frac{J_T - T_{CASE}}{V_D \cdot I_{CC}} = \theta_{JC} (^\circ C/Watt)$

Pin	Function	Description	Interface Schematic
1	GND	Ground connection. For best performance, keep traces physically short and connect immediately to ground plane.	
2	GND	Same as pin 1.	
3	GND	Same as pin 1.	
4	RF IN	RF input pin. This pin is NOT internally DC blocked. A DC blocking capacitor, suitable for the frequency of operation, should be used in most applications. DC coupling of the input is not allowed, because this will override the internal feedback loop and cause temperature instability.	
5	GND	Same as pin 1.	
6	GND	Same as pin 1.	
7	GND	Same as pin 1.	
8	RF OUT	<p>RF output and bias pin. Biasing is accomplished with an external series resistor and choke inductor to <math>V_{CC}</math>. The resistor is selected to set the DC current into this pin to a desired level. The resistor value is determined by the following equation:</p> $R = \frac{(V_{CC} - V_{DEVICE})}{I_{CC}}$ <p>Care should also be taken in the resistor selection to ensure that the current into the part never exceeds maximum datasheet operating current over the planned operating temperature. This means that a resistor between the supply and this pin is always required, even if a supply near 8.0V is available, to provide DC feedback to prevent thermal runaway. Alternatively, a constant current supply circuit may be implemented. Because DC is present on this pin, a DC blocking capacitor, suitable for the frequency of operation, should be used in most applications. The supply side of the bias network should also be well bypassed.</p>	
9	GND	Same as pin 1.	

# NBB-312

## Typical Bias Configuration

Application notes related to biasing circuit, device footprint, and thermal considerations are available on request.

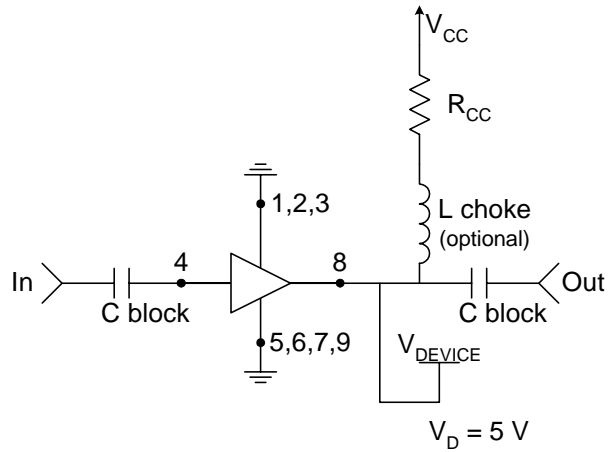

### Recommended Bias Resistor Values

Supply Voltage, $V_{CC}$ (V)	8	10	12	15	20
Bias Resistor, $R_{CC}$ ( $\Omega$ )	60	100	140	200	300

## Application Notes

### Bonding Temperature (Wedge or Ball)

It is recommended that the heater block temperature be set to  $160^{\circ}\text{C} \pm 10^{\circ}\text{C}$ .

## **Extended Frequency InGaP Amplifier Designer's Tool Kit NBB-X-K1**

This tool kit was created to assist in the design-in of the RFMD NBB- and NLB-series InGaP HBT gain block amplifiers. Each tool kit contains the following.

- 5 each NBB-300, NBB-310 and NBB-400 Ceramic Micro-X Amplifiers
- 5 each NLB-300, NLB-310 and NLB-400 Plastic Micro-X Amplifiers
- 2 Broadband Evaluation Boards and High Frequency SMA Connectors
- Broadband Bias Instructions and Specification Summary Index for ease of operation



## Tape and Reel Dimensions

All Dimensions in Millimeters

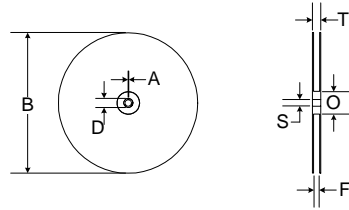

330 mm (13") REEL			Micro-X, MPGA	
	ITEMS	SYMBOL	SIZE (mm)	SIZE (inches)
FLANGE	Diameter	B	330 +0.25/-4.0	13.0 +0.079/-0.158
	Thickness	T	18.4 MAX	0.724 MAX
	Space Between Flange	F	12.4 +2.0	0.488 +0.08
HUB	Outer Diameter	O	102.0 REF	4.0 REF
	Spindle Hole Diameter	S	13.0 +0.5/-0.2	0.512 +0.020/-0.008
	Key Slit Width	A	1.5 MIN	0.059 MIN
	Key Slit Diameter	D	20.2 MIN	0.795 MIN

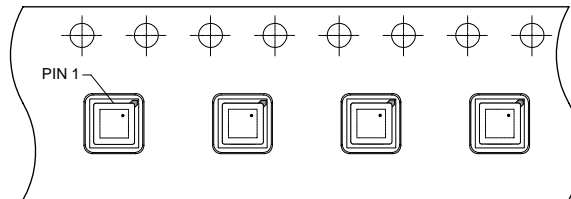

User Direction of Feed

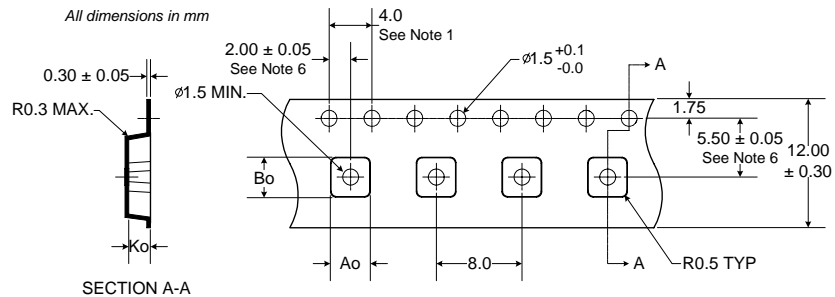

### NOTES:

- 10 sprocket hole pitch cumulative tolerance  $\pm 0.2$ .
- Camber not to exceed 1 mm in 100 mm.
- Material: PS+C
- Ao and Bo measured on a plane 0.3 mm above the bottom of the pocket.
- Ko measured from a plane on the inside bottom of the pocket to the surface of the carrier.
- Pocket position relative to sprocket hole measured as true position of pocket, not pocket hole.

Ao = 3.6 MM  
Bo = 3.6 MM  
Ko = 1.7 MM

**P1dB versus Frequency at 25°C**

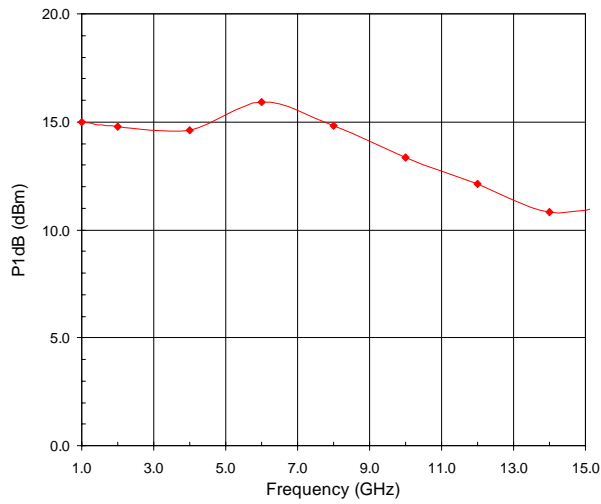

**P<sub>OUT</sub>/Gain versus P<sub>IN</sub> at 6 GHz**

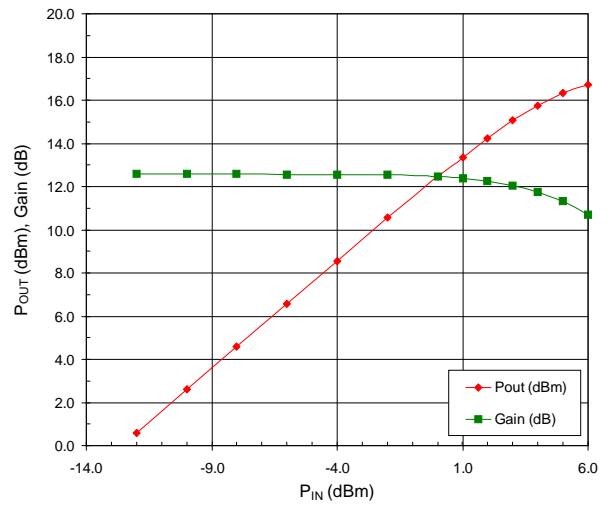

**P<sub>OUT</sub>/Gain versus P<sub>IN</sub> at 14 GHz**

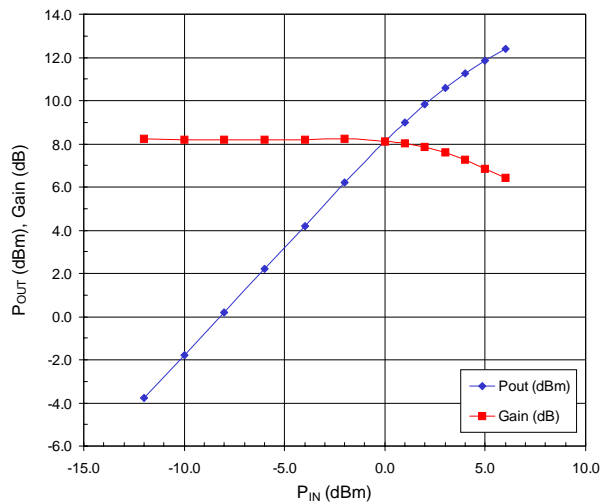

**Third Order Intercept versus Frequency at 25°C**

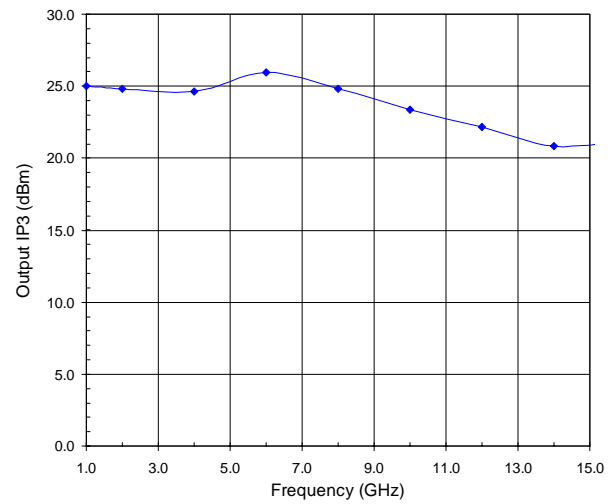

# NBB-312

Note: The s-parameter gain results shown below include device performance as well as evaluation board and connector loss variations. The insertion losses of the evaluation board and connectors are as follows:

- 1 GHz to 4 GHz=-0.06dB
- 5 GHz to 9GHz=-0.22dB
- 10GHz to 14GHz=-0.50dB
- 15GHz to 20GHz=-1.08dB

**S11 versus Frequency at +25°C**

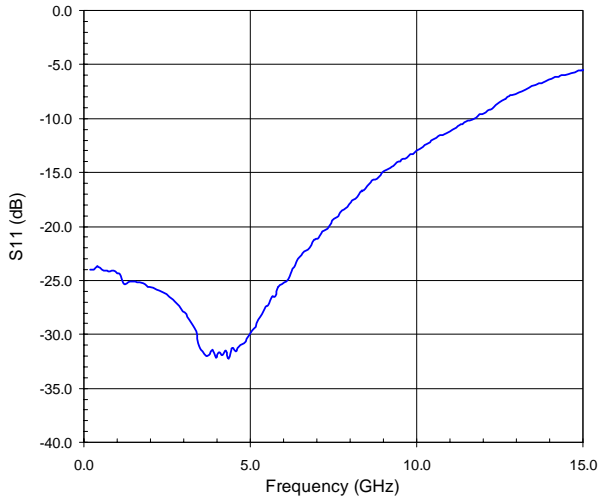

**S12 versus Frequency at +25°C**

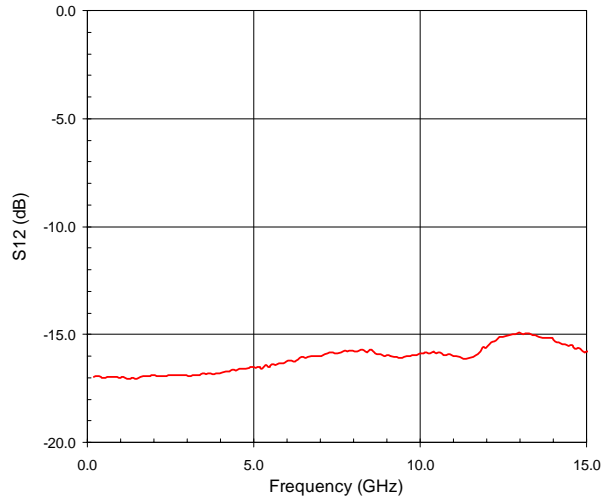

**S21 versus Frequency at +25°C**

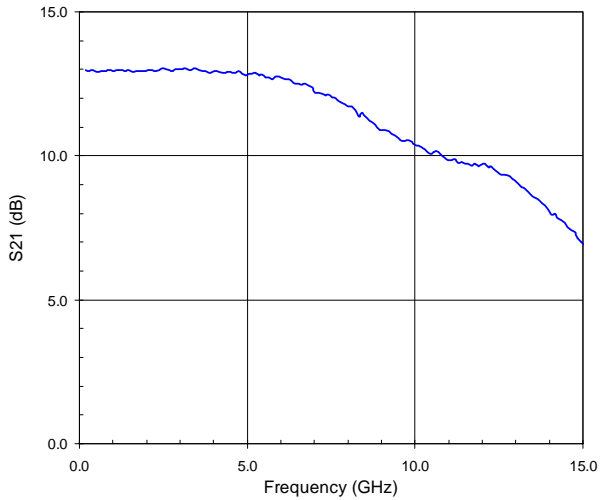

**S22 versus Frequency at +25°C**

