

# SA58632

2 × 2.2 W BTL audio amplifier

Rev. 01 — 27 June 2006

Product data sheet

## 1. General description

---

The SA58632 is a two-channel audio amplifier in an HVQFN20 package. It provides power output of 2.2 W per channel with an 8 Ω load at 9 V supply. The internal circuit is comprised of two BTL (Bridge-Tied Load) amplifiers with a complementary PNP-NPN output stage and standby/mute logic. The SA58632 is housed in a 20-pin HVQFN package, which has an exposed die attach paddle enabling reduced thermal resistance and increased power dissipation.

## 2. Features

---

- Low junction-to-ambient thermal resistance using exposed die attach paddle
- Gain can be fixed with external resistors from 6 dB to 30 dB
- Standby mode controlled by CMOS-compatible levels
- Low standby current < 10 μA
- No switch-on/switch-off plops
- High power supply ripple rejection: 50 dB minimum
- ElectroStatic Discharge (ESD) protection
- Output short circuit to ground protection
- Thermal shutdown protection

## 3. Applications

---

- Professional and amateur mobile radio
- Portable consumer products: toys and games
- Personal computer remote speakers

**PHILIPS**

## 4. Quick reference data

**Table 1. Quick reference data**

$V_{CC} = 6\text{ V}$ ;  $T_{amb} = 25\text{ °C}$ ;  $R_L = 8\ \Omega$ ;  $V_{MODE} = 0\text{ V}$ ; measured in test circuit [Figure 3](#); unless otherwise specified.

Symbol	Parameter	Conditions	Min	Typ	Max	Unit
$V_{CC}$	supply voltage	operating	2.2	9	18	V
$I_q$	quiescent current	$R_L = \infty\ \Omega$	[1] -	15	22	mA
$I_{stb}$	standby current	$V_{MODE} = V_{CC}$	-	-	10	$\mu\text{A}$
$P_o$	output power	THD+N = 10 %	1.2	1.5	-	W
		THD+N = 0.5 %	0.9	1.1	-	W
		THD+N = 10 %; $V_{CC} = 9\text{ V}$	-	2.2	-	W
THD+N	total harmonic distortion-plus-noise	$P_o = 0.5\text{ W}$	-	0.15	0.3	%
PSRR	power supply rejection ratio		[2] 50	-	-	dB
			[3] 40	-	-	dB

- [1] With a load connected at the outputs the quiescent current will increase, the maximum of this increase being equal to the DC output offset voltage divided by  $R_L$ .
- [2] Supply voltage ripple rejection is measured at the output with a source impedance of  $R_s = 0\ \Omega$  at the input. The ripple voltage is a sine wave with a frequency of 1 kHz and an amplitude of 100 mV (RMS), which is applied to the positive supply rail.
- [3] Supply voltage ripple rejection is measured at the output, with a source impedance of  $R_s = 0\ \Omega$  at the input. The ripple voltage is a sine wave with a frequency between 100 Hz and 20 kHz and an amplitude of 100 mV (RMS), which is applied to the positive supply rail.

## 5. Ordering information

**Table 2. Ordering information**

Type number	Package		Version
	Name	Description	
SA58632BS	HVQFN20	plastic thermal enhanced very thin quad flat package; no leads; 20 terminals; body $6 \times 5 \times 0.85\text{ mm}$	SOT910-1

6. Block diagram

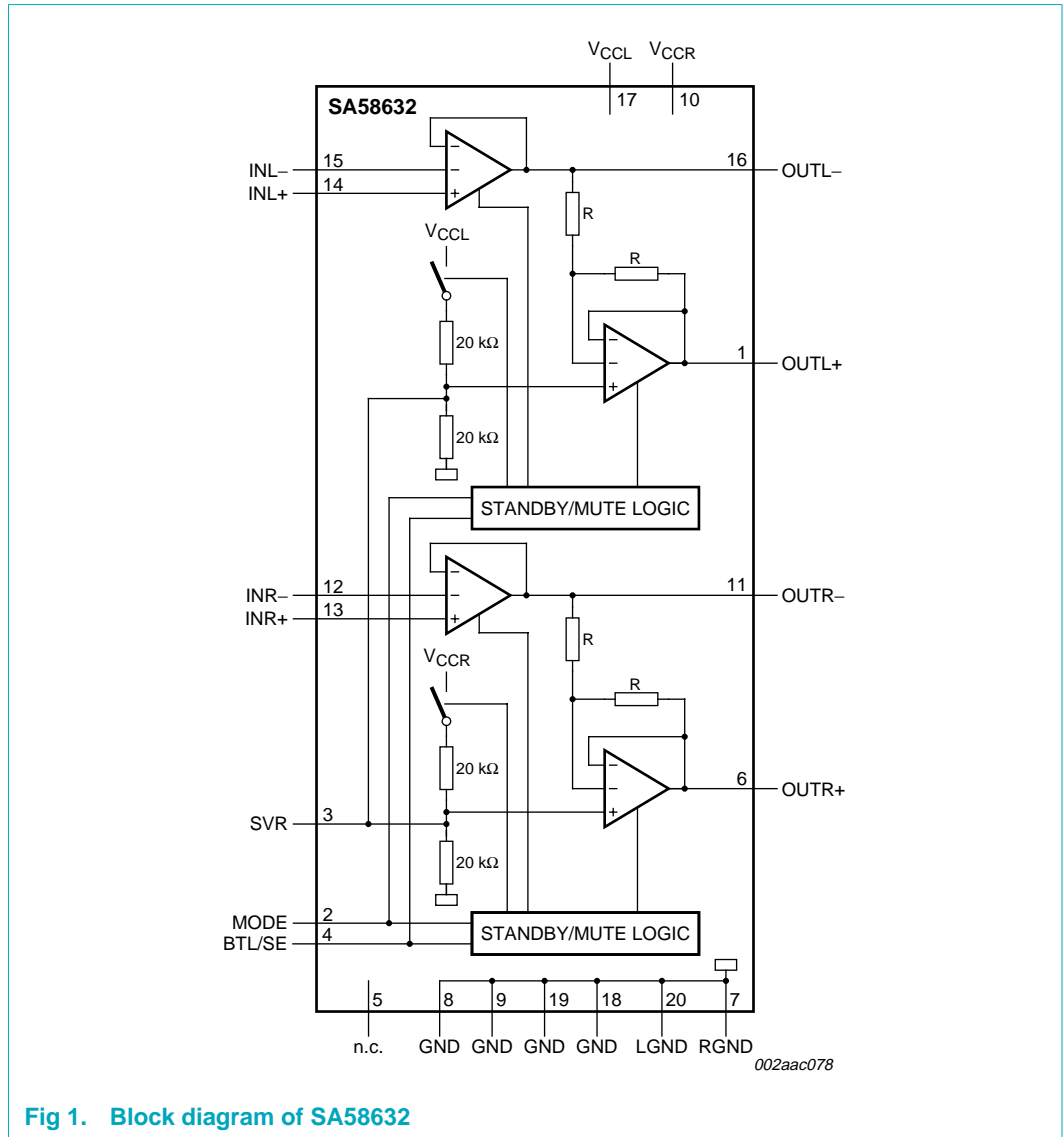
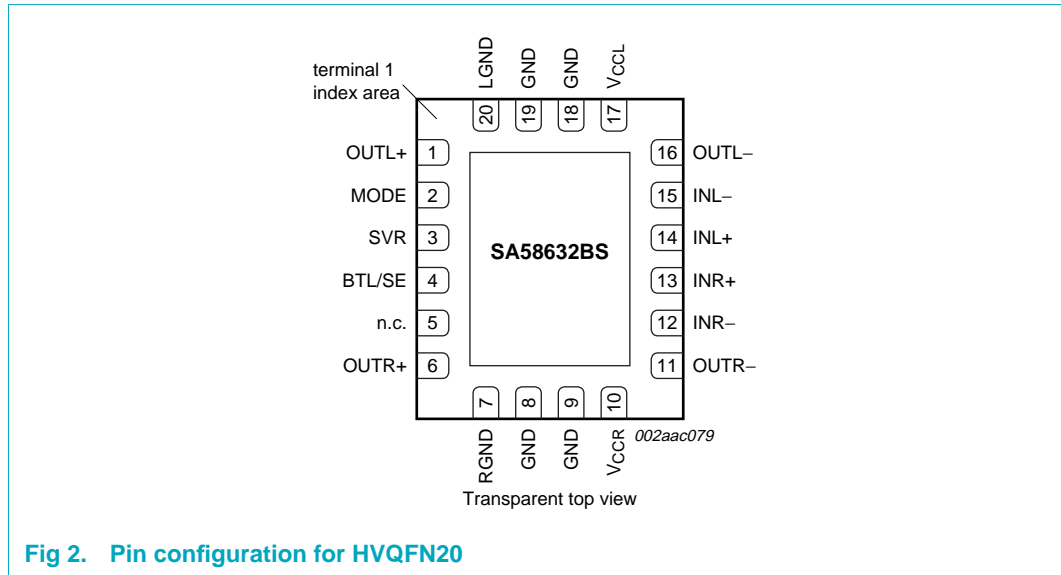

Fig 1. Block diagram of SA58632

## 7. Pinning information

### 7.1 Pinning



### 7.2 Pin description

Table 3. Pin description

Symbol	Pin	Description
OUTL+	1	positive loudspeaker terminal, left channel
MODE	2	operating mode select (standby, mute, operating)
SVR	3	half supply voltage, decoupling ripple rejection
BTL/SE	4	BTL loudspeaker or SE headphone operation
n.c.	5	not connected
OUTR+	6	positive loudspeaker terminal, right channel
RGND	7	ground, right channel
GND	8, 9, 18, 19	ground <sup>[1]</sup>
VCCR	10	supply voltage; right channel
OUTR-	11	negative loudspeaker terminal, right channel
INR-	12	negative input, right channel
INR+	13	positive input, right channel
INL+	14	positive input, left channel
INL-	15	negative input, left channel
OUTL-	16	negative output terminal, left channel
VCCL	17	supply voltage, left channel
LGND	20	ground, left channel

[1] Pins 8, 9, 18 and 19 are connected to the lead frame and also to the substrate. They may be kept floating. When connected to the ground plane, the PCB can be used as heatsink.

## 8. Functional description

The SA58632 is a two-channel BTL audio amplifier capable of delivering  $2 \times 1.5$  W output power to an  $8 \Omega$  load at THD+N = 10 % using a 6 V power supply. It is also capable of delivering  $2 \times 2.2$  W output power to an  $8 \Omega$  load at THD+N = 10 % using a 9 V power supply. Using the MODE pin, the device can be switched to standby and mute condition. The device is protected by an internal thermal shutdown protection mechanism. The gain can be set within a range of 6 dB to 30 dB by external feedback resistors.

### 8.1 Power amplifier

The power amplifier is a Bridge-Tied Load (BTL) amplifier with a complementary PNP-NPN output stage. The voltage loss on the positive supply line is the saturation voltage of a PNP power transistor, on the negative side the saturation voltage of an NPN power transistor. The total voltage loss is  $< 1$  V. With a supply voltage of 6 V and an  $8 \Omega$  loudspeaker, an output power of 1.5 W can be delivered to the load, and with a 9 V supply voltage and an  $8 \Omega$  loudspeaker an output power of 2.2 W can be delivered.

### 8.2 Mode select pin (MODE)

The device is in Standby mode (with a very low current consumption) if the voltage at the MODE pin is greater than  $V_{CC} - 0.5$  V, or if this pin is floating. At a MODE voltage in the range between 1.5 V and  $V_{CC} - 1.5$  V the amplifier is in a mute condition. The mute condition is useful to suppress pop noise at the output, caused by charging of the input capacitor. The device is in Active mode if the MODE pin is grounded or less than 0.5 V (see [Figure 6](#)).

### 8.3 BTL/SE output configuration

To invoke the BTL configuration (see [Figure 3](#)), the BTL/SE pin is taken to logic HIGH or not connected. The output differentially drives the speakers, so there is no need for coupling capacitors. The headphone can be connected to the amplifier negative outputs using a coupling capacitor for each channel. The headphone common ground is connected to the amplifier ground.

To invoke the Single-Ended (SE) configuration (see [Figure 15](#)), the BTL/SE pin is taken to logic LOW or connected to ground. The positive outputs are muted with a DC level of  $0.5V_{CC}$ . Using a coupling capacitor for each channel, speakers can be connected to the amplifier negative outputs. The speaker common ground is connected to the amplifier ground. Headphones can be connected to the negative outputs without using output coupling capacitors. The headphone common ground pin is connected to one of the amplifier positive output pins.

## 9. Limiting values

**Table 4. Limiting values**

In accordance with the Absolute Maximum Rating System (IEC 60134).

Symbol	Parameter	Conditions	Min	Max	Unit
$V_{CC}$	supply voltage	operating	-0.3	+18	V
$V_I$	input voltage		-0.3	$V_{CC} + 0.3$	V
$I_{ORM}$	repetitive peak output current		-	1	A
$T_{stg}$	storage temperature	non-operating	-55	+150	°C
$T_{amb}$	ambient temperature	operating	-40	+85	°C
$V_{P(sc)}$	short-circuit supply voltage		-	10	V
$P_{tot}$	total power dissipation	HVQFN20	-	2.2	W

## 10. Thermal characteristics

**Table 5. Thermal characteristics**

Symbol	Parameter	Conditions	Typ	Unit
$R_{th(j-a)}$	thermal resistance from junction to ambient	in free air	80	K/W
		64.5 mm <sup>2</sup> (10 square inch) heat spreader <a href="#">[1]</a>	22	K/W
$R_{th(j-sp)}$	thermal resistance from junction to solder point		3	K/W

[1] Thermal resistance is 22 K/W with DAP soldered to 64.5 mm<sup>2</sup> (10 square inch), 1 ounce copper heat spreader.

## 11. Static characteristics

**Table 6. Static characteristics**

$V_{CC} = 6$  V;  $T_{amb} = 25$  °C;  $R_L = 8$  Ω;  $V_{MODE} = 0$  V; measured in test circuit [Figure 3](#); unless otherwise specified.

Symbol	Parameter	Conditions	Min	Typ	Max	Unit
$V_{CC}$	supply voltage	operating	2.2	9	18	V
$I_q$	quiescent current	$R_L = \infty$ Ω	<a href="#">[1]</a> -	15	22	mA
$I_{stb}$	standby current	$V_{MODE} = V_{CC}$	-	-	10	μA
$V_O$	output voltage		<a href="#">[2]</a> -	2.2	-	V
$\Delta V_{O(offset)}$	differential output voltage offset		-	-	50	mV
$I_{IB}$	input bias current	pins INL+, INR+	-	-	500	nA
		pins INL-, INR-	-	-	500	nA
$V_{MODE}$	voltage on pin MODE	operating	0	-	0.5	V
		mute	1.5	-	$V_{CC} - 1.5$	V
		standby	$V_{CC} - 0.5$	-	$V_{CC}$	V
$I_{MODE}$	current on pin MODE	$0$ V < $V_{MODE}$ < $V_{CC}$	-	-	20	μA
$V_{I(SE)}$	input voltage on pin BTL/SE	single-ended (SE)	0	-	0.6	V
$V_{I(BTL)}$	input voltage on pin BTL/SE	BTL	2	-	$V_{CC}$	V
$I_{I(SE)}$	input current on pin BTL/SE	$V_{I(SE)} = 0$ V; pin connected to ground in SE mode	-	-	100	μA

- [1] With a load connected at the outputs the quiescent current will increase, the maximum of this increase being equal to the DC output offset voltage divided by  $R_L$ .
- [2] The DC output voltage with respect to ground is approximately  $0.5 \times V_{CC}$ .

## 12. Dynamic characteristics

**Table 7. Dynamic characteristics**

$V_{CC} = 6\text{ V}$ ;  $T_{amb} = 25\text{ °C}$ ;  $R_L = 8\ \Omega$ ;  $f = 1\text{ kHz}$ ;  $V_{MODE} = 0\text{ V}$ ; measured in test circuit [Figure 3](#); unless otherwise specified.

Symbol	Parameter	Conditions	Min	Typ	Max	Unit
$P_o$	output power	THD+N = 10 %	1.2	1.5	-	W
		THD+N = 0.5 %	0.9	1.1	-	W
		THD+N = 10 %; $V_{CC} = 9\text{ V}$ ; application demo board	-	2.2	-	W
THD+N	total harmonic distortion-plus-noise	$P_o = 0.5\text{ W}$	-	0.15	0.3	%
$G_{v(cl)}$	closed-loop voltage gain		[1] 6	-	30	dB
$\Delta Z_i$	differential input impedance		-	100	-	k $\Omega$
$V_{n(o)}$	noise output voltage		[2] -	-	100	$\mu\text{V}$
PSRR	power supply rejection ratio		[3] 50	-	-	dB
			[4] 40	-	-	dB
$V_{O(mute)}$	mute output voltage	mute condition	[5] -	-	200	$\mu\text{V}$
$\alpha_{cs}$	channel separation		40	-	-	dB

- [1] Gain of the amplifier is  $2 \times (R_2 / R_1)$  in test circuit of [Figure 3](#).
- [2] The noise output voltage is measured at the output in a frequency range from 20 Hz to 20 kHz (unweighted), with a source impedance of  $R_s = 0\ \Omega$  at the input.
- [3] Supply voltage ripple rejection is measured at the output with a source impedance of  $R_s = 0\ \Omega$  at the input. The ripple voltage is a sine wave with a frequency of 1 kHz and an amplitude of 100 mV (RMS), which is applied to the positive supply rail.
- [4] Supply voltage ripple rejection is measured at the output, with a source impedance of  $R_s = 0\ \Omega$  at the input. The ripple voltage is a sine wave with a frequency between 100 Hz and 20 kHz and an amplitude of 100 mV (RMS), which is applied to the positive supply rail.
- [5] Output voltage in mute position is measured with an input voltage of 1 V (RMS) in a bandwidth of 20 kHz, which includes noise.

### 13. Application information

#### 13.1 BTL application

$T_{amb} = 25\text{ }^\circ\text{C}$ ,  $V_{CC} = 9\text{ V}$ ,  $f = 1\text{ kHz}$ ,  $R_L = 8\text{ }\Omega$ ,  $G_V = 20\text{ dB}$ , audio band-pass 22 Hz to 22 kHz. The BTL diagram is shown in [Figure 3](#).

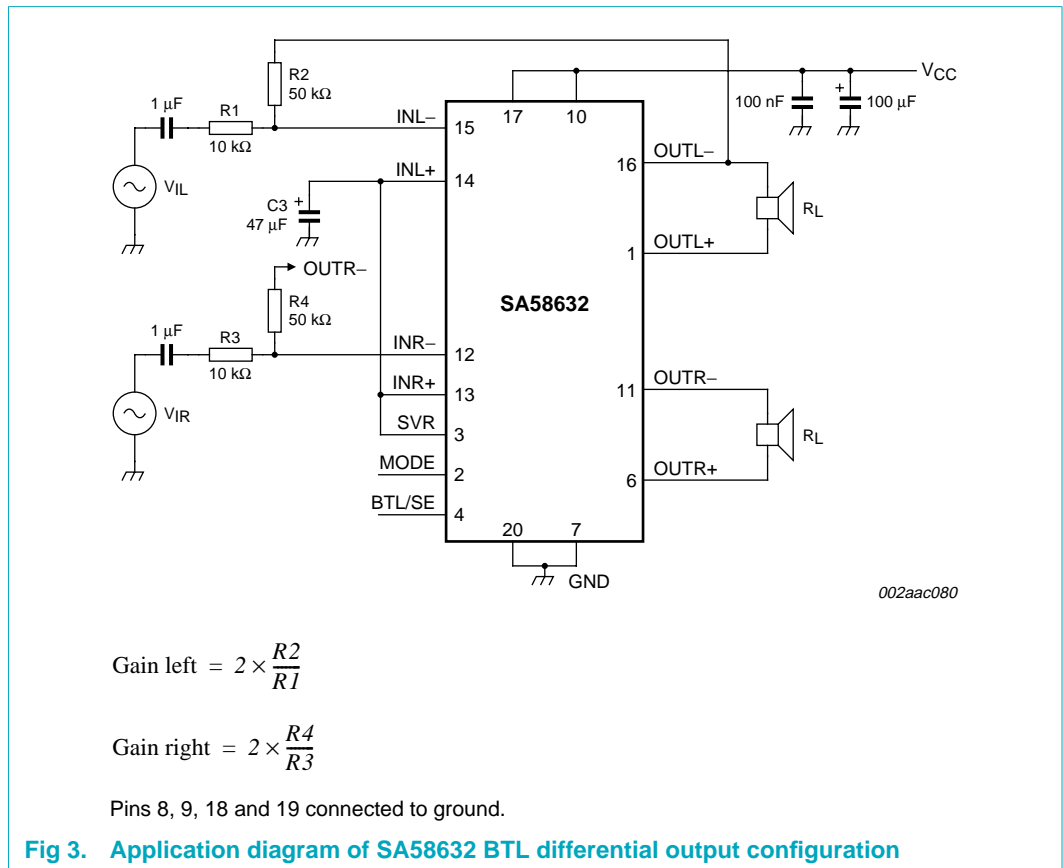



## 14. Test information

### 14.1 Static characterization

The quiescent current has been measured without any load impedance (Figure 4). Figure 6 shows three areas: operating, mute and standby. It shows that the DC switching levels of the mute and standby respectively depends on the supply voltage level.

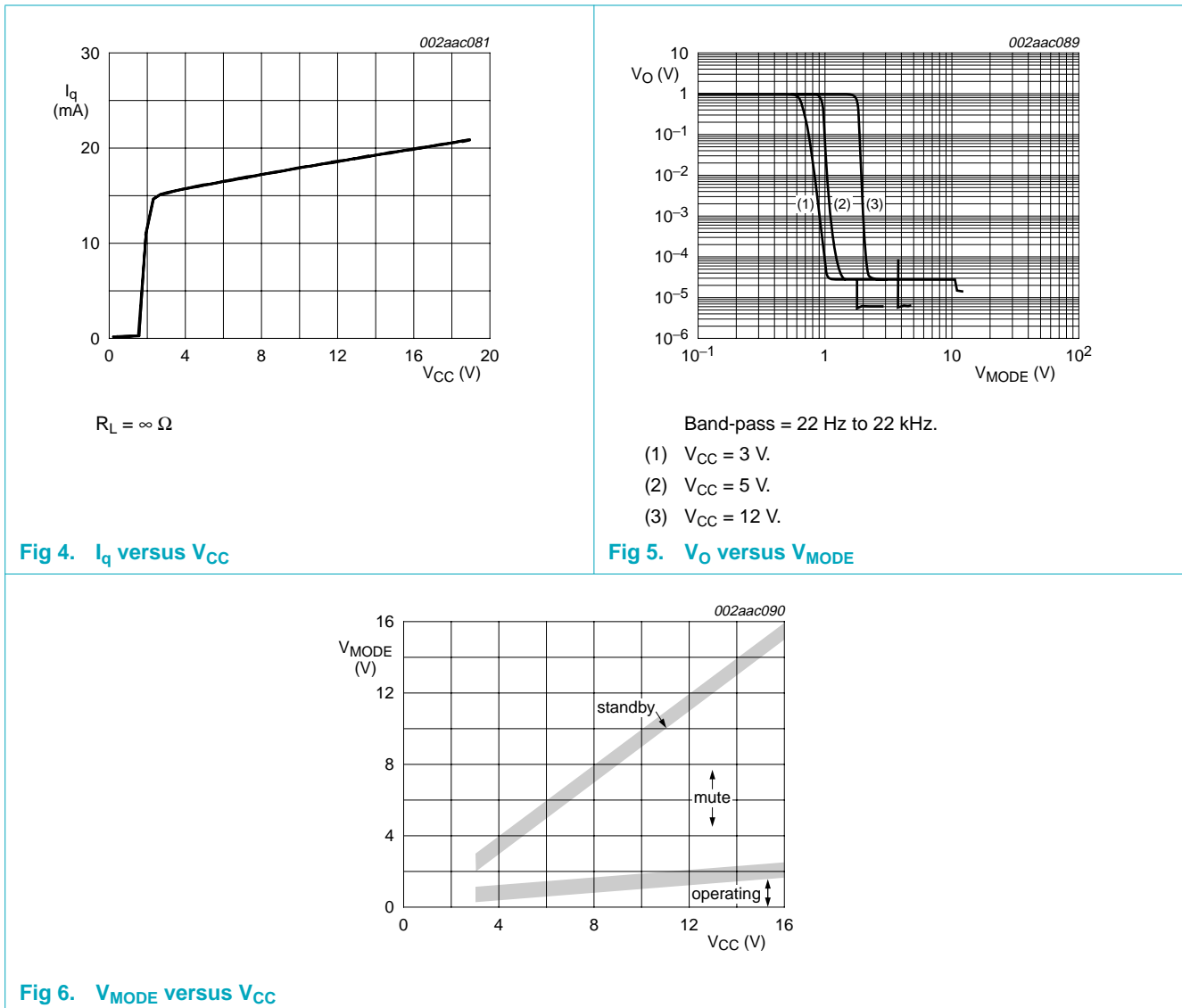

14.2 BTL dynamic characterization

The total harmonic distortion-plus-noise (THD+N) as a function of frequency (Figure 7) was measured with a low-pass filter of 80 kHz. The value of capacitor C2 influences the behavior of PSRR at low frequencies; increasing the value of C2 increases the performance of PSRR.

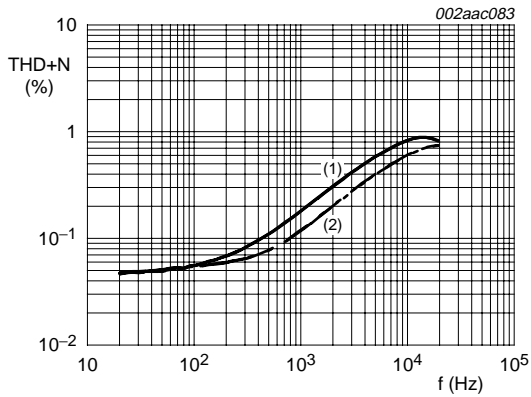

$P_o = 0.5 \text{ W}; G_v = 20 \text{ dB}.$   
 (1)  $V_{CC} = 6 \text{ V}; R_L = 8 \Omega.$   
 (2)  $V_{CC} = 7.5 \text{ V}; R_L = 16 \Omega.$

Fig 7. THD+N versus frequency

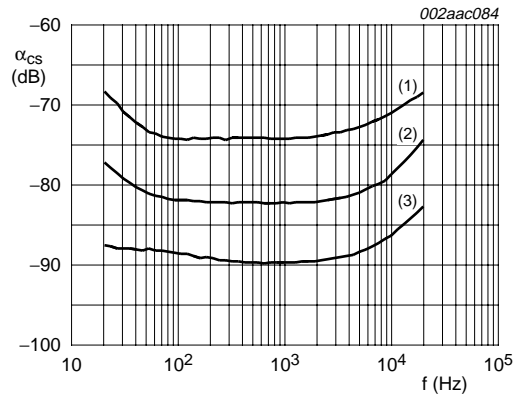

$V_{CC} = 6 \text{ V}; V_O = 2 \text{ V}; R_L = 8 \Omega.$   
 (1)  $G_v = 30 \text{ dB}.$   
 (2)  $G_v = 20 \text{ dB}.$   
 (3)  $G_v = 6 \text{ dB}.$

Fig 8. Channel separation versus frequency

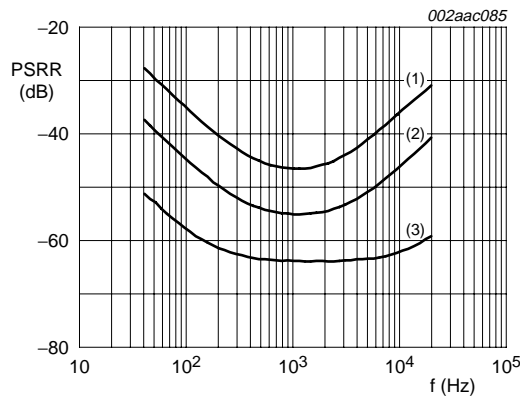

$V_{CC} = 6 \text{ V}; R_s = 0 \Omega; V_{\text{ripple}} = 100 \text{ mV}.$   
 (1)  $G_v = 30 \text{ dB}.$   
 (2)  $G_v = 20 \text{ dB}.$   
 (3)  $G_v = 6 \text{ dB}.$

Fig 9. PSRR versus frequency

### 14.3 Thermal behavior

The measured thermal performance of the HVQFN20 package is highly dependent on the configuration and size of the heat spreader on the application demo board. Data may not be comparable between different semiconductor manufacturers because the application demo boards and test methods are not standardized. Also, the thermal performance of packages for a specific application may be different than presented here, because of the configuration of the copper heat spreader of the application boards may be significantly different.

Philips Semiconductors uses FR-4 type application boards with 1 ounce copper traces with solder coating.

The demo board (see [Figure 23](#)) has a 1 ounce copper heat spreader that runs under the IC and provides a mounting pad to solder to the die attach paddle of the HVQFN20 package. The heat spreader is symmetrical and provides a heat spreader on both top and bottom of the PCB. The heat spreader on top and bottom side of the demo board is connected through 2 mm diameter plated through holes. Directly under the DAP (Die Attach Paddle), the top and bottom side of the PCB are connected by four vias. The total top and bottom heat spreader area is 64.5 mm<sup>2</sup> (10 in<sup>2</sup>).

The junction to ambient thermal resistance,  $R_{th(j-a)} = 22$  K/W for the HVQFN20 package when the exposed die attach paddle is soldered to 5 square inch area of 1 ounce copper heat spreader on the demo PCB. The maximum sine wave power dissipation for  $T_{amb} = 25$  °C is:

$$\frac{150 - 25}{22} = 5.7 \text{ W}$$

Thus, for  $T_{amb} = 60$  °C the maximum total power dissipation is:

$$\frac{150 - 60}{22} = 4.1 \text{ W}$$

The power dissipation versus ambient temperature curve ([Figure 10](#)) shows the power derating profiles with ambient temperature for three sizes of heat spreaders. For a more modest heat spreader using 5 square inch area on the top or bottom side of the PCB, the  $R_{th(j-a)}$  is 31 K/W. When the package is not soldered to a heat spreader, the  $R_{th(j-a)}$  increases to 60 K/W.

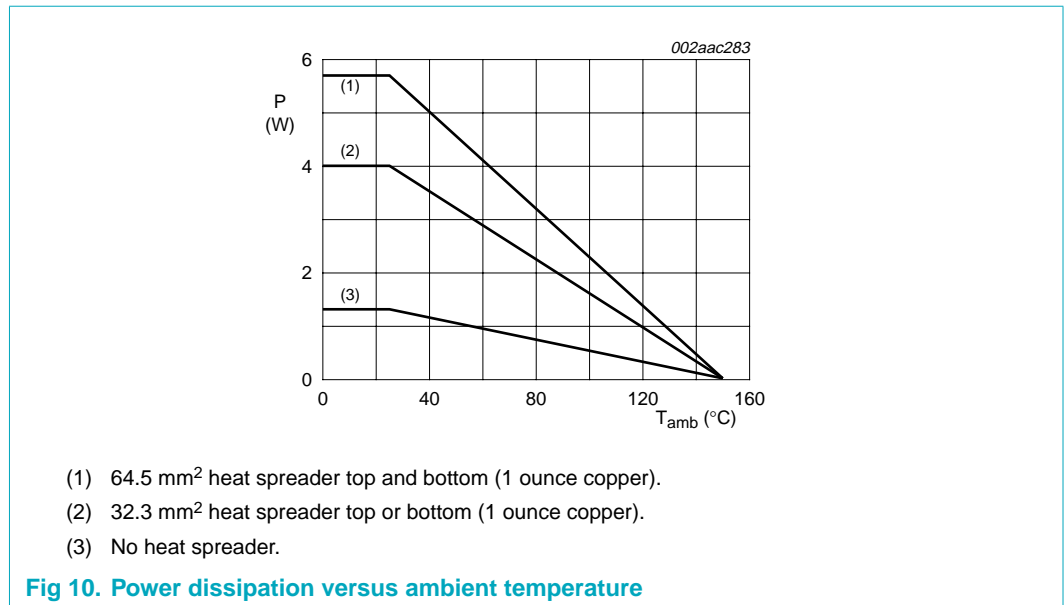

The characteristics curves ([Figure 11a](#) and [Figure 11b](#), [Figure 12](#), [Figure 13a](#) and [Figure 13b](#), and [Figure 14](#)) show the room temperature performance for SA58632 using the demo PCB shown in [Figure 23](#). For example, [Figure 11](#) “Power dissipation versus output power” (a and b) show the performance as a function of load resistance and supply voltage. Worst case power dissipation is shown in [Figure 12](#). [Figure 13a](#) shows that the part delivers typically 2.8 W per channel for THD+N = 10 % using 8 Ω load at 9 V supply, while [Figure 13b](#) shows that the part delivers 3.3 W per channel at 12 V supply and 16 Ω load, THD+N = 10 %.

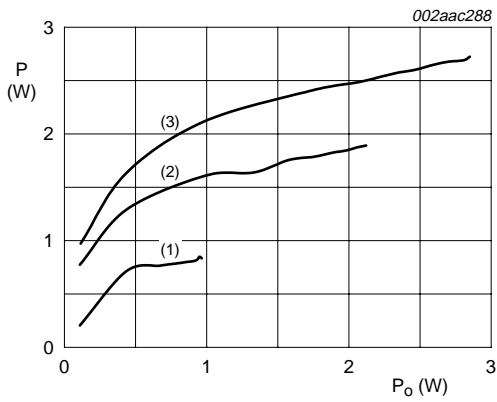

- (1)  $V_{CC} = 6\text{ V}$ .
- (2)  $V_{CC} = 7.5\text{ V}$ .
- (3)  $V_{CC} = 9\text{ V}$ .

a.  $R_L = 8\ \Omega$ ;  $f = 1\text{ kHz}$ ;  $G_v = 20\text{ dB}$

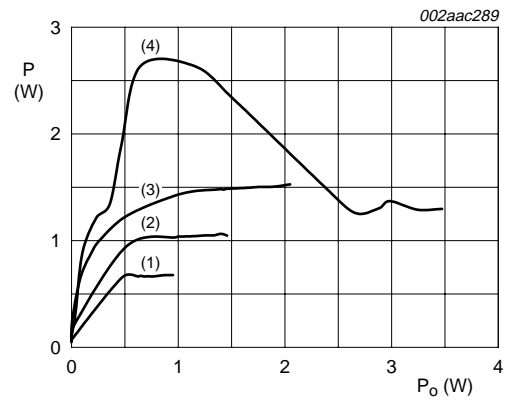

- (1)  $V_{CC} = 6\text{ V}$ .
- (2)  $V_{CC} = 7.5\text{ V}$ .
- (3)  $V_{CC} = 9\text{ V}$ .
- (4)  $V_{CC} = 12\text{ V}$ .

b.  $R_L = 16\ \Omega$ ;  $f = 1\text{ kHz}$ ;  $G_v = 20\text{ dB}$

Fig 11. Power dissipation versus output power

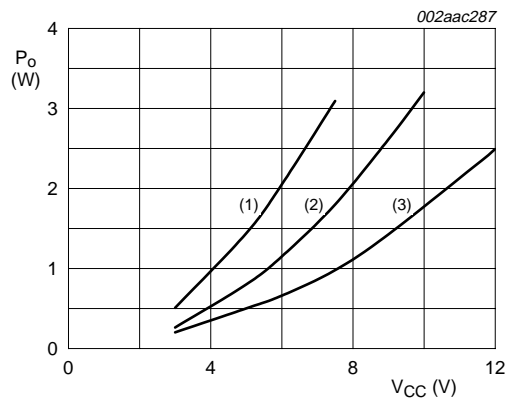

- (1)  $R_L = 4\ \Omega$ .
- (2)  $R_L = 8\ \Omega$ .
- (3)  $R_L = 16\ \Omega$ .

Fig 12. Worst case power dissipation versus  $V_{CC}$

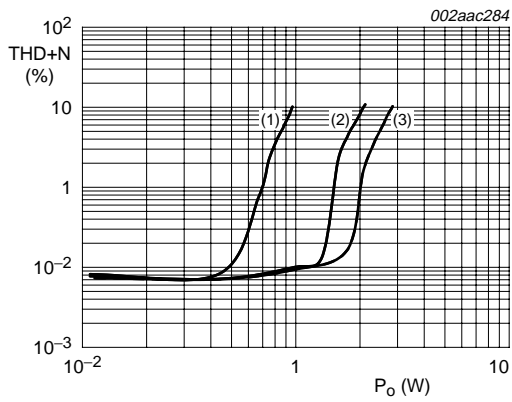

- (1)  $V_{CC} = 6\text{ V}$ .
- (2)  $V_{CC} = 7.5\text{ V}$ .
- (3)  $V_{CC} = 9\text{ V}$ .

a.  $R_L = 8\ \Omega$ ;  $f = 1\text{ kHz}$ ;  $G_v = 20\text{ dB}$

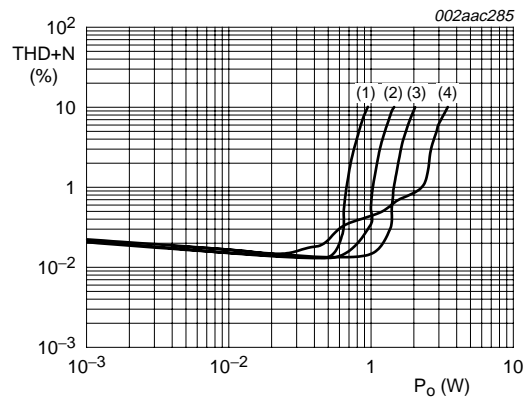

- (1)  $V_{CC} = 6\text{ V}$ .
- (2)  $V_{CC} = 7.5\text{ V}$ .
- (3)  $V_{CC} = 9\text{ V}$ .
- (4)  $V_{CC} = 12\text{ V}$ .

b.  $R_L = 16\ \Omega$ ;  $f = 1\text{ kHz}$ ;  $G_v = 20\text{ dB}$

Fig 13. THD+N versus output power

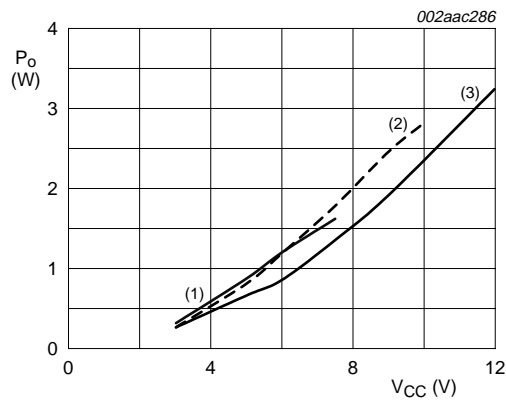

THD+N = 10 %;  $f = 1\text{ kHz}$ ;  $G_v = 20\text{ dB}$ .

- (1)  $R_L = 4\ \Omega$ .
- (2)  $R_L = 8\ \Omega$ .
- (3)  $R_L = 16\ \Omega$ .

Fig 14. Output power versus  $V_{CC}$

14.4 Single-ended application

T<sub>amb</sub> = 25 °C; V<sub>CC</sub> = 7.5 V; f = 1 kHz; R<sub>L</sub> = 8 Ω; G<sub>v</sub> = 20 dB; audio band-pass 20 Hz to 20 kHz.

The single-ended application diagram is shown in [Figure 15](#).

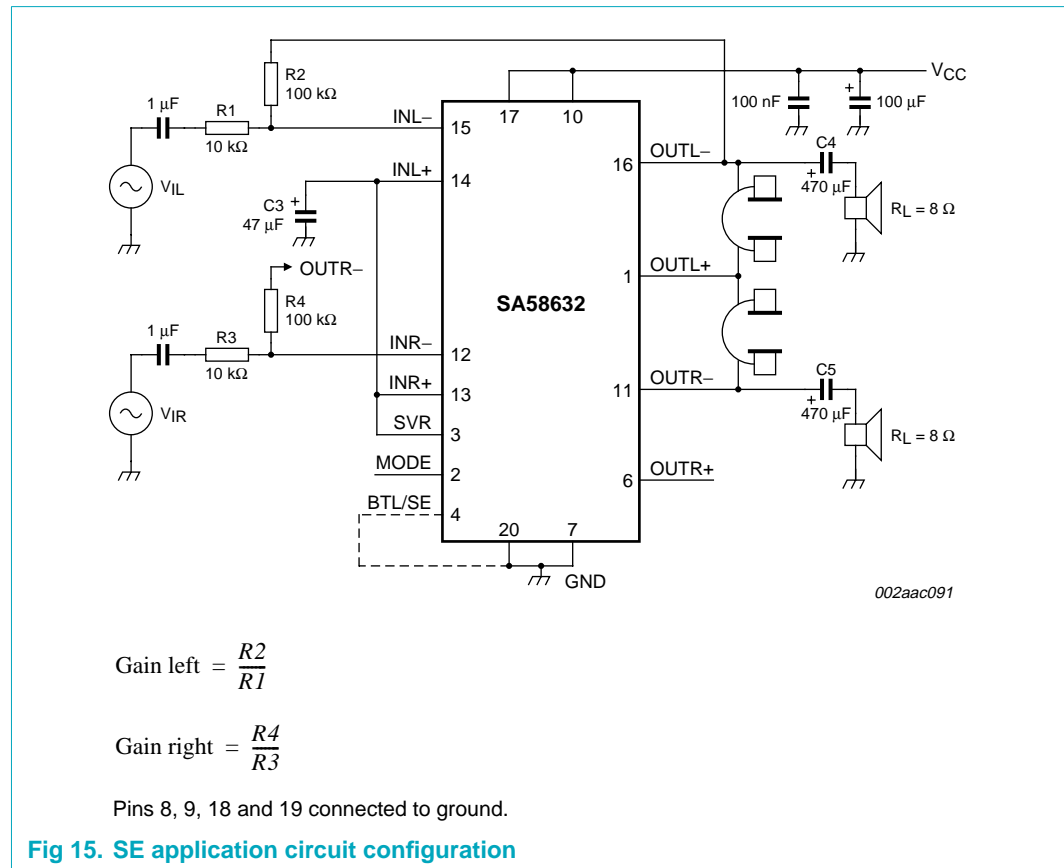

If the BTL/SE pin is to ground, the positive outputs (OUTL+, OUTR+) will be in mute condition with a DC level of 0.5V<sub>CC</sub>. When a headphone is used (R<sub>L</sub> > 25 Ω) the SE headphone application can be used without coupling capacitors by placing the load between negative output and one of the positive outputs (for example, pin 1) as the common pin.

Increasing the value of the tantalum or electrolytic capacitor C3 will result in a better channel separation. Because the positive output is not designed for high output current (2 × I<sub>O</sub>) at the load impedance (< 16 Ω), the SE application with output capacitors connected to ground is advised. The capacitor value of C4/C5 in combination with the load impedance determines the low frequency behavior. The total harmonic distortion-plus-noise as a function of frequency was measured with a low-pass filter of 80 kHz. The value of the capacitor C3 influences the behavior of the PSRR at low frequencies; increasing the value of C3 increases the performance of PSRR.

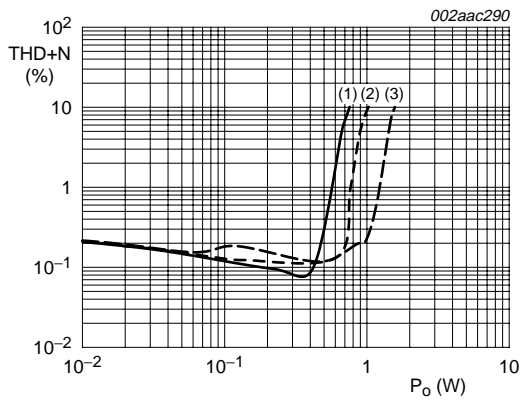

- (1)  $V_{CC} = 7.5\text{ V}$ .
- (2)  $V_{CC} = 9\text{ V}$ .
- (3)  $V_{CC} = 12\text{ V}$ .
- a.  $R_L = 4\ \Omega$ ;  $f = 1\text{ kHz}$ ;  $G_V = 10\text{ dB}$

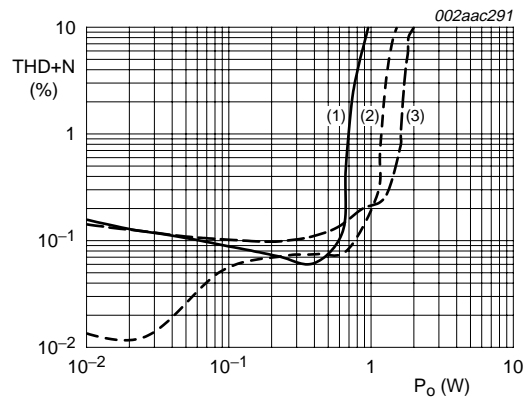

- (1)  $V_{CC} = 9\text{ V}$ .
- (2)  $V_{CC} = 12\text{ V}$ .
- (3)  $V_{CC} = 15\text{ V}$ .
- b.  $R_L = 8\ \Omega$ ;  $f = 1\text{ kHz}$ ;  $G_V = 10\text{ dB}$

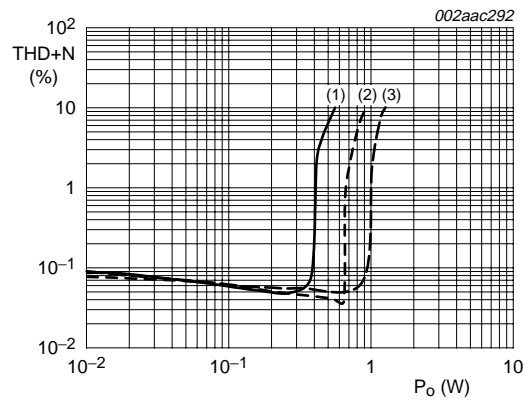

- (1)  $V_{CC} = 9\text{ V}$ .
- (2)  $V_{CC} = 12\text{ V}$ .
- (3)  $V_{CC} = 15\text{ V}$ .
- c.  $R_L = 16\ \Omega$ ;  $f = 1\text{ kHz}$ ;  $G_V = 10\text{ dB}$

Fig 16. THD+N versus output power



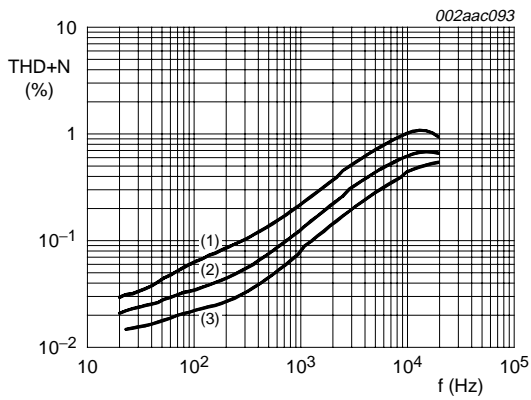

$P_o = 0.5 \text{ W}; G_v = 20 \text{ dB}.$   
 (1)  $V_{CC} = 7.5 \text{ V}; R_L = 4 \Omega.$   
 (2)  $V_{CC} = 9 \text{ V}; R_L = 8 \Omega.$   
 (3)  $V_{CC} = 12 \text{ V}; R_L = 16 \Omega.$

Fig 17. THD+N versus frequency

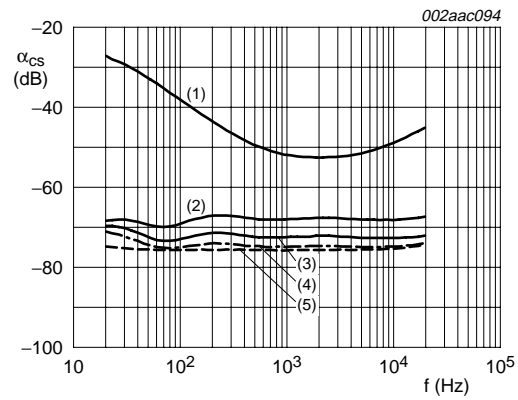

$V_o = 1 \text{ V}; G_v = 20 \text{ dB}.$   
 (1)  $V_{CC} = 5 \text{ V}; R_L = 32 \Omega, \text{ to buffer}.$   
 (2)  $V_{CC} = 7.5 \text{ V}; R_L = 4 \Omega.$   
 (3)  $V_{CC} = 9 \text{ V}; R_L = 8 \Omega.$   
 (4)  $V_{CC} = 12 \text{ V}; R_L = 16 \Omega.$   
 (5)  $V_{CC} = 5 \text{ V}; R_L = 32 \Omega.$

Fig 18. Channel separation versus frequency

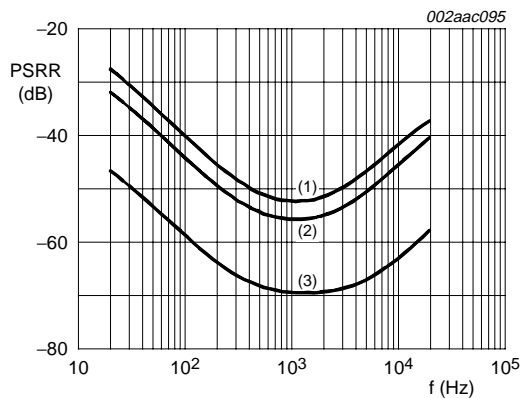

$R_s = 0 \Omega; V_{\text{ripple}} = 100 \text{ mV}.$   
 (1)  $G_v = 24 \text{ dB}.$   
 (2)  $G_v = 20 \text{ dB}.$   
 (3)  $G_v = 0 \text{ dB}.$

Fig 19. PSRR versus frequency

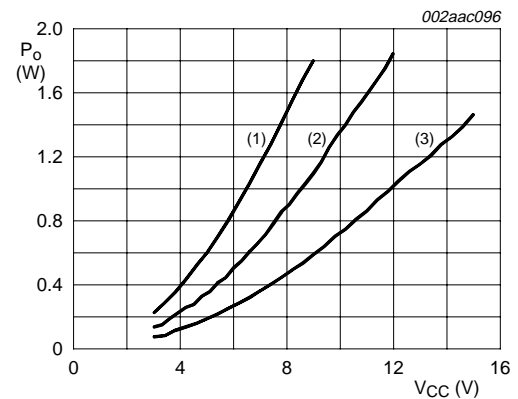

$\text{THD+N} = 10 \text{ \%}.$   
 (1)  $R_L = 4 \Omega.$   
 (2)  $R_L = 8 \Omega.$   
 (3)  $R_L = 16 \Omega.$

Fig 20.  $P_o$  versus  $V_{CC}$

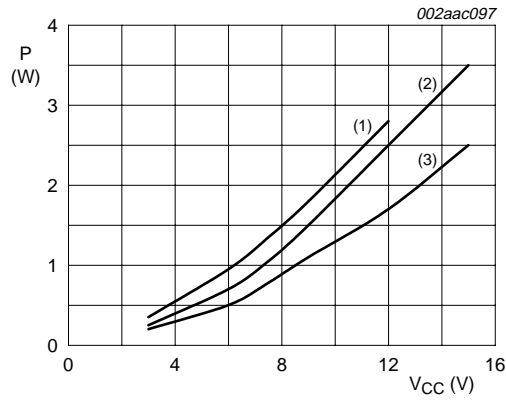

THD+N = 10 %.

- (1) R<sub>L</sub> = 4 Ω.
- (2) R<sub>L</sub> = 8 Ω.
- (3) R<sub>L</sub> = 16 Ω.

Fig 21. Worst case power dissipation versus V<sub>CC</sub>

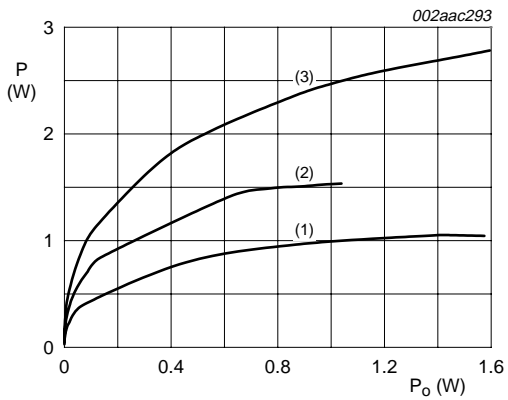

- (1) V<sub>CC</sub> = 7.5 V.
  - (2) V<sub>CC</sub> = 9 V.
  - (3) V<sub>CC</sub> = 12 V.
- a. R<sub>L</sub> = 4 Ω; f = 1 kHz; G<sub>v</sub> = 10 dB

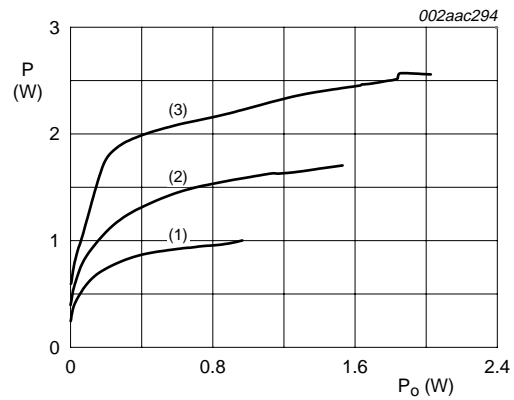

- (1) V<sub>CC</sub> = 9 V.
  - (2) V<sub>CC</sub> = 12 V.
  - (3) V<sub>CC</sub> = 15 V.
- b. R<sub>L</sub> = 8 Ω; f = 1 kHz; G<sub>v</sub> = 10 dB

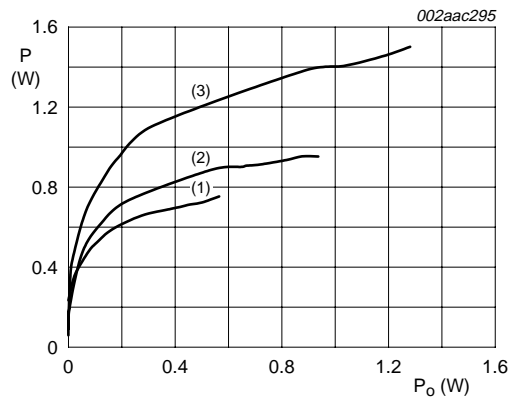

- (1) V<sub>CC</sub> = 9 V.
  - (2) V<sub>CC</sub> = 12 V.
  - (3) V<sub>CC</sub> = 15 V.
- c. R<sub>L</sub> = 16 Ω; f = 1 kHz; G<sub>v</sub> = 10 dB

Fig 22. Power dissipation versus output power

### 14.5 General remarks

The frequency characteristics can be adapted by connecting a small capacitor across the feedback resistor. To improve the immunity of HF radiation in radio circuit applications, a small capacitor can be connected in parallel with the feedback resistor (56 kΩ); this creates a low-pass filter.

### 14.6 SA58632BS PCB demo

The application demo board may be used for evaluation in either BTL or SE configuration as shown in the schematics in [Figure 3](#) and [Figure 15](#). The demo PCB is laid out for a 64.5 mm<sup>2</sup> (10 in<sup>2</sup>) heat spreader (total of top and bottom heat spreader area).

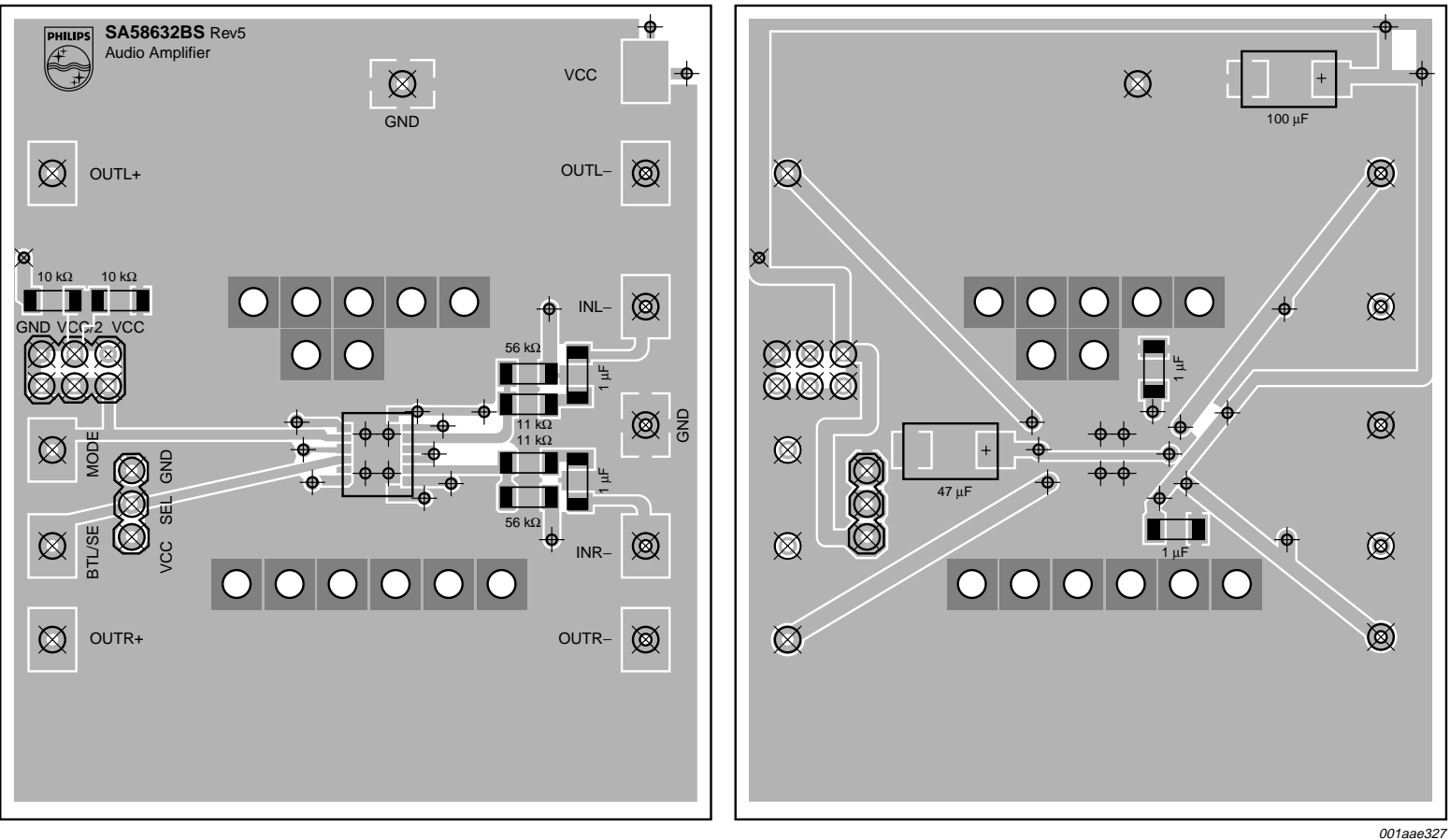

001aae327

Fig 23. SA58632BS PCB demo

15. Package outline

HVQFN20: plastic thermal enhanced very thin quad flat package; no leads;  
20 terminals; body 6 × 5 × 0.85 mm

SOT910-1

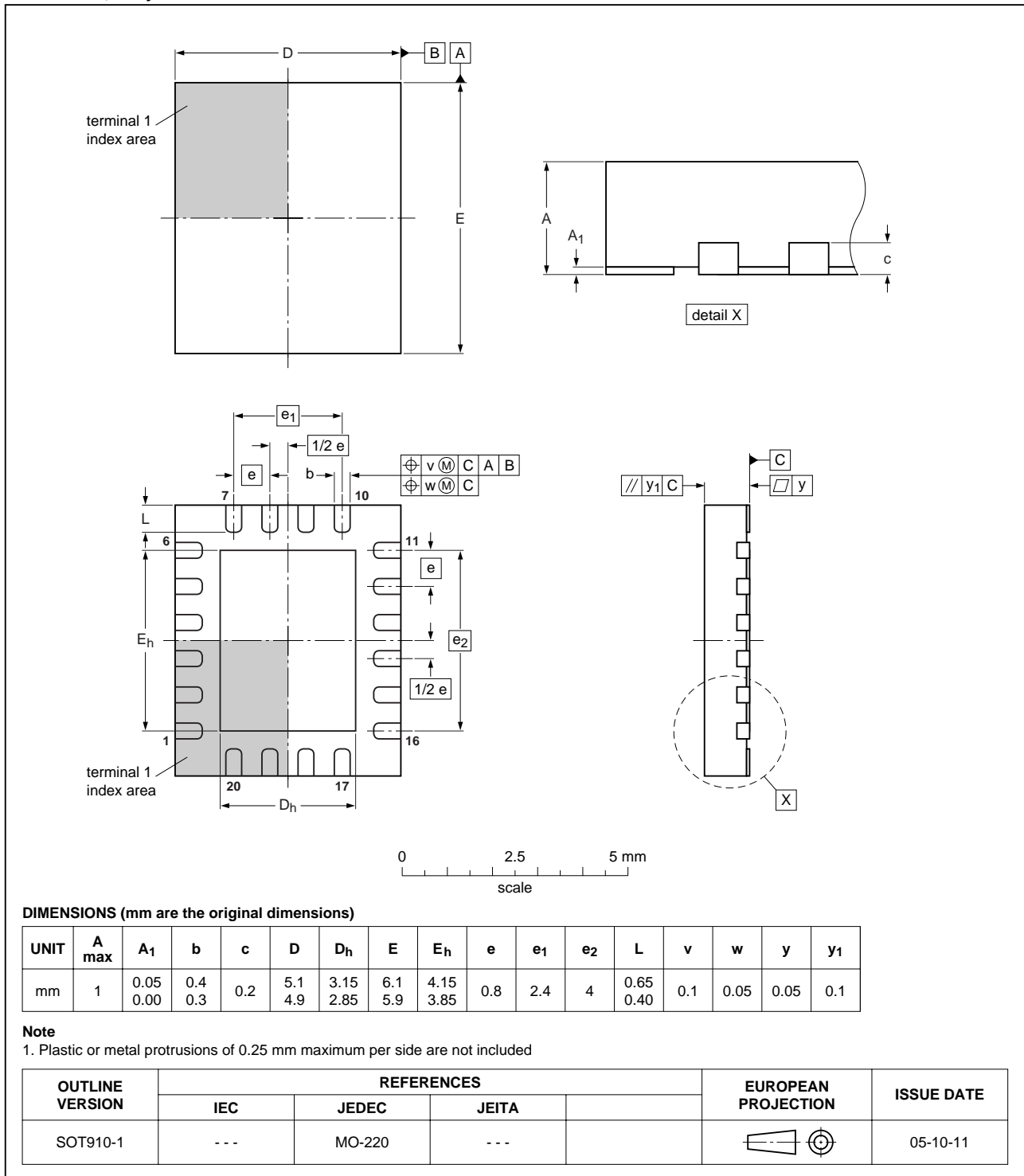

Fig 24. Package outline SOT910-1 (HVQFN20)

## 16. Soldering

### 16.1 Introduction to soldering surface mount packages

There is no soldering method that is ideal for all surface mount IC packages. Wave soldering can still be used for certain surface mount ICs, but it is not suitable for fine pitch SMDs. In these situations reflow soldering is recommended.

### 16.2 Reflow soldering

Reflow soldering requires solder paste (a suspension of fine solder particles, flux and binding agent) to be applied to the printed-circuit board by screen printing, stencilling or pressure-syringe dispensing before package placement. Driven by legislation and environmental forces the worldwide use of lead-free solder pastes is increasing.

Several methods exist for reflowing; for example, convection or convection/infrared heating in a conveyor type oven. Throughput times (preheating, soldering and cooling) vary between 100 seconds and 200 seconds depending on heating method.

Typical reflow temperatures range from 215 °C to 260 °C depending on solder paste material. The peak top-surface temperature of the packages should be kept below:

**Table 8. SnPb eutectic process - package peak reflow temperatures (from J-STD-020C July 2004)**

Package thickness	Volume mm <sup>3</sup> < 350	Volume mm <sup>3</sup> ≥ 350
< 2.5 mm	240 °C + 0/-5 °C	225 °C + 0/-5 °C
≥ 2.5 mm	225 °C + 0/-5 °C	225 °C + 0/-5 °C

**Table 9. Pb-free process - package peak reflow temperatures (from J-STD-020C July 2004)**

Package thickness	Volume mm <sup>3</sup> < 350	Volume mm <sup>3</sup> 350 to 2000	Volume mm <sup>3</sup> > 2000
< 1.6 mm	260 °C + 0 °C	260 °C + 0 °C	260 °C + 0 °C
1.6 mm to 2.5 mm	260 °C + 0 °C	250 °C + 0 °C	245 °C + 0 °C
≥ 2.5 mm	250 °C + 0 °C	245 °C + 0 °C	245 °C + 0 °C

Moisture sensitivity precautions, as indicated on packing, must be respected at all times.

### 16.3 Wave soldering

Conventional single wave soldering is not recommended for surface mount devices (SMDs) or printed-circuit boards with a high component density, as solder bridging and non-wetting can present major problems.

To overcome these problems the double-wave soldering method was specifically developed.

If wave soldering is used the following conditions must be observed for optimal results:

- Use a double-wave soldering method comprising a turbulent wave with high upward pressure followed by a smooth laminar wave.
- For packages with leads on two sides and a pitch (e):

- larger than or equal to 1.27 mm, the footprint longitudinal axis is **preferred** to be parallel to the transport direction of the printed-circuit board;
- smaller than 1.27 mm, the footprint longitudinal axis **must** be parallel to the transport direction of the printed-circuit board.

The footprint must incorporate solder thieves at the downstream end.

- For packages with leads on four sides, the footprint must be placed at a 45° angle to the transport direction of the printed-circuit board. The footprint must incorporate solder thieves downstream and at the side corners.

During placement and before soldering, the package must be fixed with a droplet of adhesive. The adhesive can be applied by screen printing, pin transfer or syringe dispensing. The package can be soldered after the adhesive is cured.

Typical dwell time of the leads in the wave ranges from 3 seconds to 4 seconds at 250 °C or 265 °C, depending on solder material applied, SnPb or Pb-free respectively.

A mildly-activated flux will eliminate the need for removal of corrosive residues in most applications.

## 16.4 Manual soldering

Fix the component by first soldering two diagonally-opposite end leads. Use a low voltage (24 V or less) soldering iron applied to the flat part of the lead. Contact time must be limited to 10 seconds at up to 300 °C.

When using a dedicated tool, all other leads can be soldered in one operation within 2 seconds to 5 seconds between 270 °C and 320 °C.

## 16.5 Package related soldering information

**Table 10. Suitability of surface mount IC packages for wave and reflow soldering methods**

Package <sup>[1]</sup>	Soldering method	
	Wave	Reflow <sup>[2]</sup>
BGA, HTSSON..T <sup>[3]</sup> , LBGA, LFBGA, SQFP, SSOP..T <sup>[3]</sup> , TFBGA, VFBGA, XSON	not suitable	suitable
DHVQFN, HBCC, HBGA, HLQFP, HSO, HSOP, HSQFP, HSSON, HTQFP, HTSSOP, HVQFN, HVSON, SMS	not suitable <sup>[4]</sup>	suitable
PLCC <sup>[5]</sup> , SO, SOJ	suitable	suitable
LQFP, QFP, TQFP	not recommended <sup>[5][6]</sup>	suitable
SSOP, TSSOP, VSO, VSSOP	not recommended <sup>[7]</sup>	suitable
CWQCCN..L <sup>[8]</sup> , PMFP <sup>[9]</sup> , WQCCN..L <sup>[8]</sup>	not suitable	not suitable

[1] For more detailed information on the BGA packages refer to the *(LF)BGA Application Note* (AN01026); order a copy from your Philips Semiconductors sales office.

[2] All surface mount (SMD) packages are moisture sensitive. Depending upon the moisture content, the maximum temperature (with respect to time) and body size of the package, there is a risk that internal or external package cracks may occur due to vaporization of the moisture in them (the so called popcorn effect). For details, refer to the Drypack information in the *Data Handbook IC26; Integrated Circuit Packages; Section: Packing Methods*.

- [3] These transparent plastic packages are extremely sensitive to reflow soldering conditions and must on no account be processed through more than one soldering cycle or subjected to infrared reflow soldering with peak temperature exceeding  $217\text{ °C} \pm 10\text{ °C}$  measured in the atmosphere of the reflow oven. The package body peak temperature must be kept as low as possible.
- [4] These packages are not suitable for wave soldering. On versions with the heatsink on the bottom side, the solder cannot penetrate between the printed-circuit board and the heatsink. On versions with the heatsink on the top side, the solder might be deposited on the heatsink surface.
- [5] If wave soldering is considered, then the package must be placed at a  $45^\circ$  angle to the solder wave direction. The package footprint must incorporate solder thieves downstream and at the side corners.
- [6] Wave soldering is suitable for LQFP, QFP and TQFP packages with a pitch (e) larger than 0.8 mm; it is definitely not suitable for packages with a pitch (e) equal to or smaller than 0.65 mm.
- [7] Wave soldering is suitable for SSOP, TSSOP, VSO and VSSOP packages with a pitch (e) equal to or larger than 0.65 mm; it is definitely not suitable for packages with a pitch (e) equal to or smaller than 0.5 mm.
- [8] Image sensor packages in principle should not be soldered. They are mounted in sockets or delivered pre-mounted on flex foil. However, the image sensor package can be mounted by the client on a flex foil by using a hot bar soldering process. The appropriate soldering profile can be provided on request.
- [9] Hot bar soldering or manual soldering is suitable for PMFP packages.

## 17. Abbreviations

**Table 11. Abbreviations**

Acronym	Description
BTL	Bridge-Tied Load
CMOS	Complementary Metal Oxide Semiconductor
DAP	Die Attach Paddle
ESD	ElectroStatic Discharge
NPN	Negative-Positive-Negative
PCB	Printed-Circuit Board
PNP	Positive-Negative-Positive
RMS	Root Mean Squared
SE	Single-Ended
THD	Total Harmonic Distortion

## 18. Revision history

**Table 12. Revision history**

Document ID	Release date	Data sheet status	Change notice	Supersedes
SA58632_1	20060627	Product data sheet	-	-



## 19. Legal information

### 19.1 Data sheet status

Document status <sup>[1][2]</sup>	Product status <sup>[3]</sup>	Definition
Objective [short] data sheet	Development	This document contains data from the objective specification for product development.
Preliminary [short] data sheet	Qualification	This document contains data from the preliminary specification.
Product [short] data sheet	Production	This document contains the product specification.

[1] Please consult the most recently issued document before initiating or completing a design.

[2] The term 'short data sheet' is explained in section "Definitions".

[3] The product status of device(s) described in this document may have changed since this document was published and may differ in case of multiple devices. The latest product status information is available on the Internet at URL <http://www.semiconductors.philips.com>.

### 19.2 Definitions

**Draft** — The document is a draft version only. The content is still under internal review and subject to formal approval, which may result in modifications or additions. Philips Semiconductors does not give any representations or warranties as to the accuracy or completeness of information included herein and shall have no liability for the consequences of use of such information.

**Short data sheet** — A short data sheet is an extract from a full data sheet with the same product type number(s) and title. A short data sheet is intended for quick reference only and should not be relied upon to contain detailed and full information. For detailed and full information see the relevant full data sheet, which is available on request via the local Philips Semiconductors sales office. In case of any inconsistency or conflict with the short data sheet, the full data sheet shall prevail.

### 19.3 Disclaimers

**General** — Information in this document is believed to be accurate and reliable. However, Philips Semiconductors does not give any representations or warranties, expressed or implied, as to the accuracy or completeness of such information and shall have no liability for the consequences of use of such information.

**Right to make changes** — Philips Semiconductors reserves the right to make changes to information published in this document, including without limitation specifications and product descriptions, at any time and without notice. This document supersedes and replaces all information supplied prior to the publication hereof.

**Suitability for use** — Philips Semiconductors products are not designed, authorized or warranted to be suitable for use in medical, military, aircraft, space or life support equipment, nor in applications where failure or

malfunction of a Philips Semiconductors product can reasonably be expected to result in personal injury, death or severe property or environmental damage. Philips Semiconductors accepts no liability for inclusion and/or use of Philips Semiconductors products in such equipment or applications and therefore such inclusion and/or use is at the customer's own risk.

**Applications** — Applications that are described herein for any of these products are for illustrative purposes only. Philips Semiconductors makes no representation or warranty that such applications will be suitable for the specified use without further testing or modification.

**Limiting values** — Stress above one or more limiting values (as defined in the Absolute Maximum Ratings System of IEC 60134) may cause permanent damage to the device. Limiting values are stress ratings only and operation of the device at these or any other conditions above those given in the Characteristics sections of this document is not implied. Exposure to limiting values for extended periods may affect device reliability.

**Terms and conditions of sale** — Philips Semiconductors products are sold subject to the general terms and conditions of commercial sale, as published at <http://www.semiconductors.philips.com/profile/terms>, including those pertaining to warranty, intellectual property rights infringement and limitation of liability, unless explicitly otherwise agreed to in writing by Philips Semiconductors. In case of any inconsistency or conflict between information in this document and such terms and conditions, the latter will prevail.

**No offer to sell or license** — Nothing in this document may be interpreted or construed as an offer to sell products that is open for acceptance or the grant, conveyance or implication of any license under any copyrights, patents or other industrial or intellectual property rights.

### 19.4 Trademarks

Notice: All referenced brands, product names, service names and trademarks are the property of their respective owners.

## 20. Contact information

For additional information, please visit: <http://www.semiconductors.philips.com>

For sales office addresses, send an email to: [sales.addresses@www.semiconductors.philips.com](mailto:sales.addresses@www.semiconductors.philips.com)

## 21. Contents

<b>1</b>	<b>General description</b> .....	<b>1</b>
<b>2</b>	<b>Features</b> .....	<b>1</b>
<b>3</b>	<b>Applications</b> .....	<b>1</b>
<b>4</b>	<b>Quick reference data</b> .....	<b>2</b>
<b>5</b>	<b>Ordering information</b> .....	<b>2</b>
<b>6</b>	<b>Block diagram</b> .....	<b>3</b>
<b>7</b>	<b>Pinning information</b> .....	<b>4</b>
7.1	Pinning .....	4
7.2	Pin description .....	4
<b>8</b>	<b>Functional description</b> .....	<b>5</b>
8.1	Power amplifier .....	5
8.2	Mode select pin (MODE) .....	5
8.3	BTL/SE output configuration .....	5
<b>9</b>	<b>Limiting values</b> .....	<b>6</b>
<b>10</b>	<b>Thermal characteristics</b> .....	<b>6</b>
<b>11</b>	<b>Static characteristics</b> .....	<b>6</b>
<b>12</b>	<b>Dynamic characteristics</b> .....	<b>7</b>
<b>13</b>	<b>Application information</b> .....	<b>8</b>
13.1	BTL application .....	8
<b>14</b>	<b>Test information</b> .....	<b>9</b>
14.1	Static characterization .....	9
14.2	BTL dynamic characterization .....	10
14.3	Thermal behavior .....	11
14.4	Single-ended application .....	15
14.5	General remarks .....	19
14.6	SA58632BS PCB demo .....	19
<b>15</b>	<b>Package outline</b> .....	<b>21</b>
<b>16</b>	<b>Soldering</b> .....	<b>22</b>
16.1	Introduction to soldering surface mount packages .....	22
16.2	Reflow soldering .....	22
16.3	Wave soldering .....	22
16.4	Manual soldering .....	23
16.5	Package related soldering information .....	23
<b>17</b>	<b>Abbreviations</b> .....	<b>24</b>
<b>18</b>	<b>Revision history</b> .....	<b>24</b>
<b>19</b>	<b>Legal information</b> .....	<b>25</b>
19.1	Data sheet status .....	25
19.2	Definitions .....	25
19.3	Disclaimers .....	25
19.4	Trademarks .....	25
<b>20</b>	<b>Contact information</b> .....	<b>25</b>
<b>21</b>	<b>Contents</b> .....	<b>26</b>

Please be aware that important notices concerning this document and the product(s) described herein, have been included in section 'Legal information'.



© Koninklijke Philips Electronics N.V. 2006. All rights reserved.

For more information, please visit: <http://www.semiconductors.philips.com>.

For sales office addresses, email to: [sales.addresses@www.semiconductors.philips.com](mailto:sales.addresses@www.semiconductors.philips.com).

Date of release: 27 June 2006

Document identifier: SA58632\_1