

Features

- SIP (Single in-line package)
- Output voltage programmable from 0.75 Vdc to 3.3 Vdc via external resistor
- Up to 10 A output current
- Up to 95 % efficiency
- Small size, low profile, cost-efficient open frame design
- Low output ripple and noise
- High reliability
- Remote on/off
- Remote sense
- Output overcurrent protection (non-latching)
- Overtemperature protection
- Constant switching frequency (300 kHz)
- Wide operating temperature range
- Optional sequencing function

SX(T)10A-3-5SA SIP Non-Isolated Power Module

Description

Bourns® SX(T)10A-3-5SA is a non-isolated DC-DC converter offering designers a cost and space-efficient solution with standard features such as remote on/off, remote sense, precisely regulated programmable output voltage, overcurrent and over-temperature protection, and optional output voltage sequencing. These modules deliver up to 10 A of output current with full load efficiency of 95 % at 3.3 V output.

How to Order

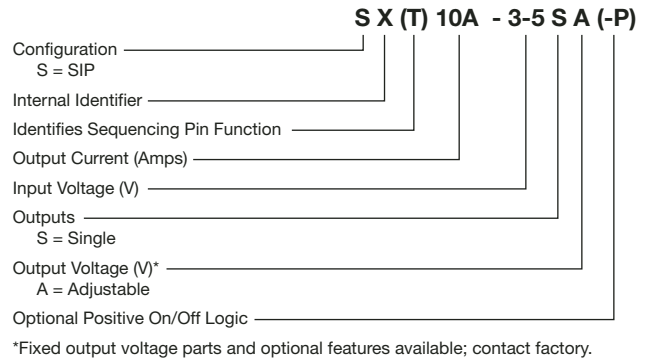

Absolute Maximum Ratings

Stress in excess of absolute maximum ratings may cause permanent damage to the device. Device reliability may be affected if exposed to absolute maximum ratings for extended time periods.

Characteristic	Min.	Max.	Units	Notes & Conditions
Continuous Input Voltage	-0.3	5.8	V _{dc}	
Operating Temperature Range	-40	+85	°C	See Thermal Considerations section
Storage Temperature	-55	+125	°C	
Sequencing Function	-0.3	V _{in} , max.	V _{dc}	

Electrical Specifications

Unless otherwise specified, specifications apply over all input voltage, resistive load and temperature conditions.

Characteristic	Min.	Nom.	Max.	Units	Notes & Conditions
Operating Input Voltage	2.4		5.5	V _{dc}	V _{out} ≤ V _{in} - 0.5 V
Maximum Input Current	-		10.0	A _{dc}	Over V _{in} range, I _o max, V _{out} = 3.3 V _{dc}
Input No Load Current		25 30		mA mA	V _{in} = 5.0 V _{dc} , I _o = 0 A, mod. enabled, -V _{out} = 0.75 V _{dc} -V _{out} = 3.3 V _{dc}
Input Stand-by Current		1.5		mA	V _{in} = 5.0 V _{dc} , module disabled
Inrush Transient			0.1	A ² s	
Input Reflected Ripple Current		100		mA _{p-p}	
Input Ripple Rejection		30		dB	120 Hz

Caution: The power modules are not internally fused. An external input line time delay fuse with a maximum rating of 15 A is required. See the Safety Considerations section of this data sheet.

Applications

- Intermediate Bus architecture
- Distributed power applications
- Workstations and servers
- Telecom equipment
- Enterprise networks including LANs/WANs
- Latest generation ICs (DSP, FPGA, ASIC) and microprocessor powered applications

*RoHS Directive 2002/95/EC Jan 27 2003 including Annex.
 Specifications are subject to change without notice.
 Customers should verify device performance in their specific applications.

SX(T)10A-3-5SA SIP Non-Isolated Power Module

BOURNS®

Electrical Specifications (Continued)

Characteristic	Min.	Nom.	Max.	Units	Notes & Conditions
Output Voltage Setpoint Accuracy	-2.0		2.0	% $V_{O,set}$	V_{in} min, I_O max, $T_A = 25\text{ °C}$
Output Voltage Tolerance	-3.0		3.0	% $V_{O,set}$	Over all rated in out voltage, load and temperature conditions
Voltage Adjustment Range	0.7525		3.63	V_{dc}	
Line Regulation		0.3		% $V_{O,set}$	
Load Regulation		0.4		% $V_{O,set}$	
Temperature Regulation		0.4		% $V_{O,set}$	
Output Current	0.0		10.0	A_{dc}	
Output Current Limit Inception (Hiccup Mode)		220		% I_O max	
Output Short Circuit Current		3		A_{dc}	$V_O \leq 250\text{ mV}$ – Hiccup Mode
Output Ripple and Noise Voltage RMS Peak-to-Peak		8 25	15 50	mVrms mVpk-pk	1 μF ceramic/10 μF tantalum capacitors 5 Hz to 20 MHz bandwidth
External Capacitance - ESR $\geq 1\text{ m}\Omega$ - ESR $\geq 10\text{ m}\Omega$			1000 5000	μF μF	
Efficiency ($V_{in} = 5\text{ V}_{dc}$, $T_A = 25\text{ °C}$, Full Load)		82.5 88.0 89.5 91.0 93.0 95.0		% % % % % %	$V_{O,set} = 0.75\text{ V}_{dc}$ $V_{O,set} = 1.2\text{ V}_{dc}$ $V_{O,set} = 1.5\text{ V}_{dc}$ $V_{O,set} = 1.8\text{ V}_{dc}$ $V_{O,set} = 2.5\text{ V}_{dc}$ $V_{O,set} = 3.3\text{ V}_{dc}$
Switching Frequency		300		kHz	
Dynamic Load Response 5 A to 10 A; 10 A to 5 A; ($\Delta i/\Delta t = 2.5\text{ A}/\mu\text{s}$; 25 °C)		200 25		mV μs	1 μF ceramic/10 μF tantalum capacitor Peak Deviation Settling Time ($V_O < 10\%$ peak deviation)
5 A to 10 A; 10 A to 5 A; ($\Delta i/\Delta t = 2.5\text{ A}/\mu\text{s}$; 25 °C)		100 100		mV μs	3 x 100 μF polymer capacitors Peak Deviation Settling Time ($V_O < 10\%$ peak deviation)

General Specifications

Characteristic	Nom.	Units	Notes & Conditions
Calculated MTBF	13,675,000	hours	
Weight	5.4 (0.19)	g (oz.)	

SX(T)10A-3-5SA SIP Non-Isolated Power Module

BOURNS®

Feature Specifications

Characteristic	Min.	Nom.	Max.	Units	Notes & Conditions
Remote Enable Open = On (Logic Low) Low = Off (Logic High)	>2.5		0.4 5.5	V_{dc} V_{dc}	10 μ A max. 1 mA max.
Turn-On Delay and Rise Times Case 1: On/Off Low – V_{in} Applied Case 2: V_{in} Applied, then On/Off Set Low Case 3: Output Voltage Rise		2.5 2.5 3.0		msec msec msec	(10 %-90 % of V_O setting)
Sequencing Delay Time	10			msec	Delay from V_{in} , min. to application of voltage on SEQ pin
Tracking Accuracy		100 200	200 400	mV mV	Power Up: 2 V/ms Power Down: 1 V/ms
Output Voltage Overshoot			1	% $V_{O, set}$	I_O max, $V_{in}=5.5$, $T_A=25$ °C
Remote Sense Range			0.5	V_{dc}	
Overtemperature Protection		125		°C	See Thermal Consideration section
Input Undervoltage Lockout -Turn-on Threshold -Turn-off Threshold		2.2 2.0		V V	

Characteristic Curves

The curves provided below are typical characteristics for the SX(T)10A-3-5SA modules at 25 °C. For any specific test configurations or any specific test requests, please contact Bourns.

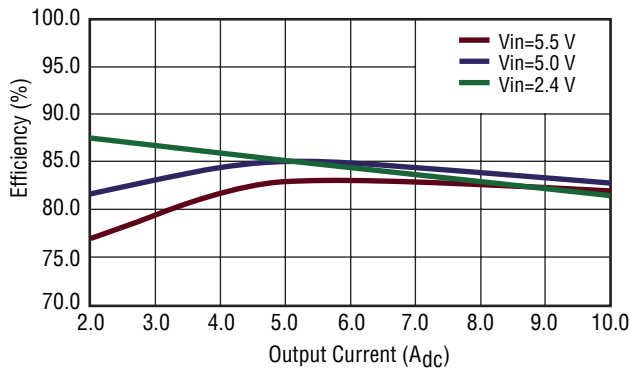

Fig. 1 Efficiency vs. Output Current ($V_{out} = 0.75 V_{dc}$)

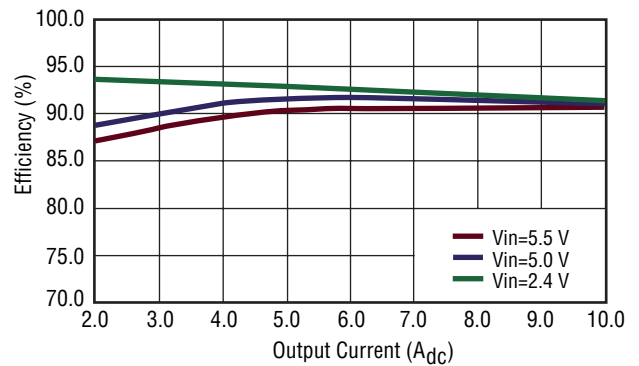

Fig. 4 Efficiency vs. Output Current ($V_{out} = 1.8 V_{dc}$)

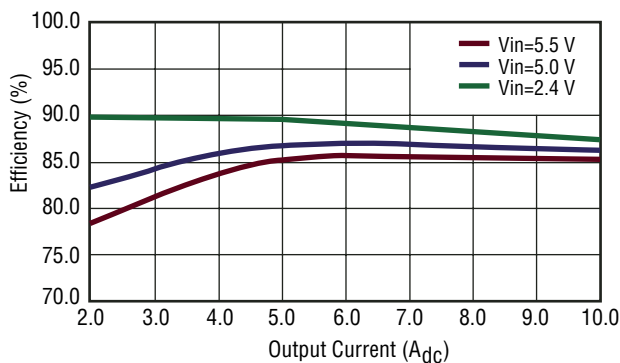

Fig. 2 Efficiency vs. Output Current ($V_{out} = 1.2 V_{dc}$)

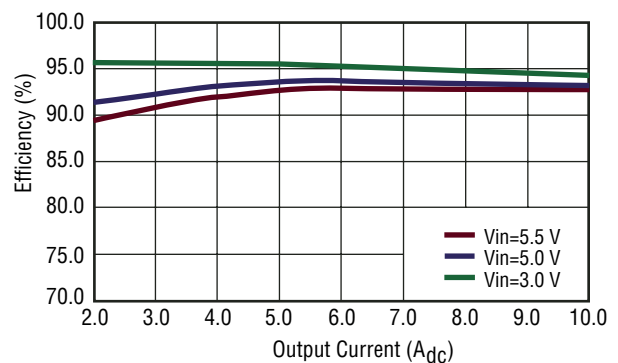

Fig. 5 Efficiency vs. Output Current ($V_{out} = 2.5 V_{dc}$)

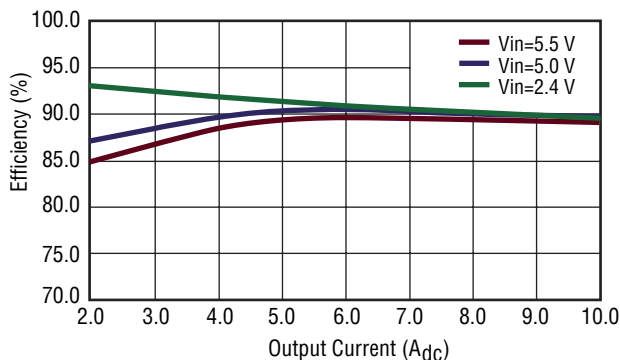

Fig. 3 Efficiency vs. Output Current ($V_{out} = 1.5 V_{dc}$)

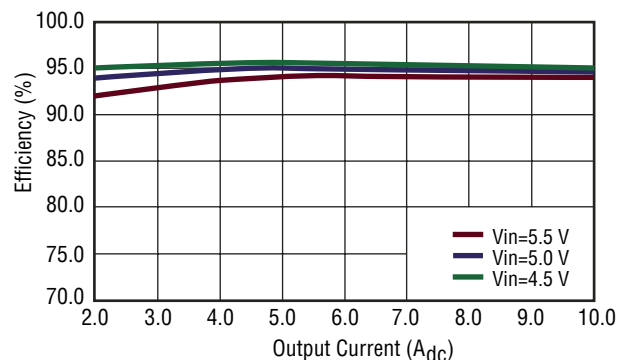

Fig. 6 Efficiency vs. Output Current ($V_{out} = 3.3 V_{dc}$)

Characteristic Curves (Continued)

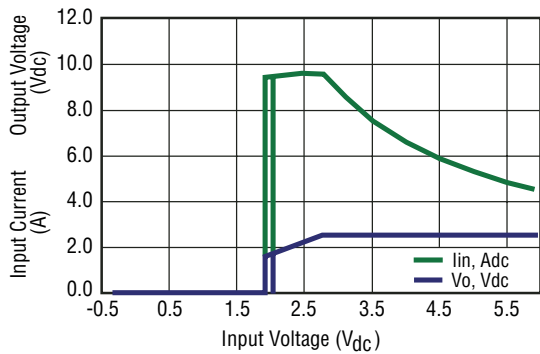

Fig. 7 Input Voltage vs. I_o and V_o
 ($V_o = 2.5 V_{dc}$, $I_o = 10.0 A$)

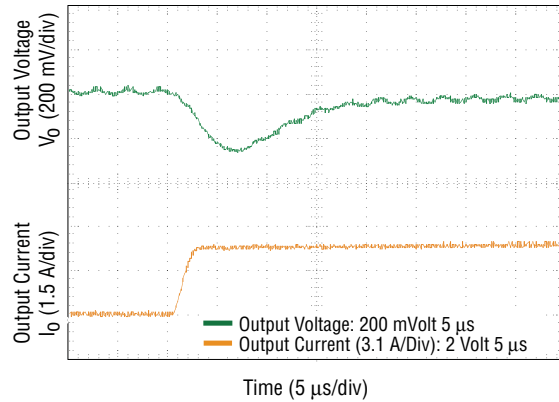

Fig. 10 Transient Response - 5 A - 10 A Step
 ($V_o = 3.3 V_{dc}$)

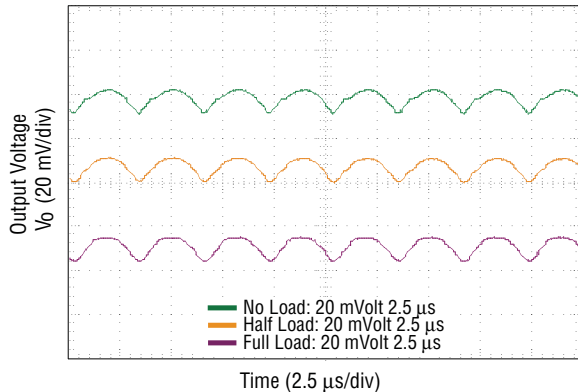

Fig. 8 Typical Output Ripple and Noise
 ($V_{in} = 5.0 V$, $V_o = 0.75 V$, $I_o = 10.0 A$)

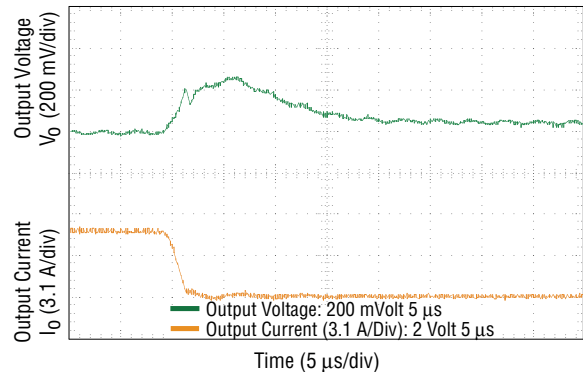

Fig. 11 Transient Response - 10 A - 5 A Step
 ($V_o = 3.3 V_{dc}$)

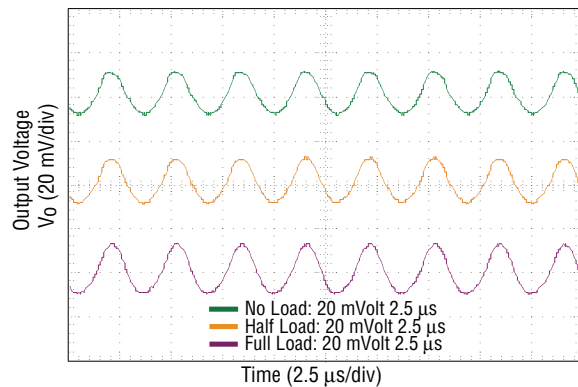

Fig. 9 Typical Output Ripple and Noise
 ($V_{in} = 5.0 V$, $V_o = 3.3 V$, $I_o = 10.0 A$)

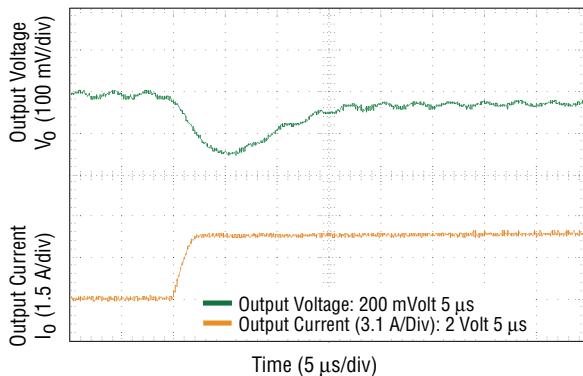

Fig. 12 Transient Response - 5 A - 10 A Step
 ($V_o = 3.3 V_{dc}$, $C_{ext} = 3 \times 100 \mu F$ Polymer Capacitors)

Characteristic Curves (Continued)

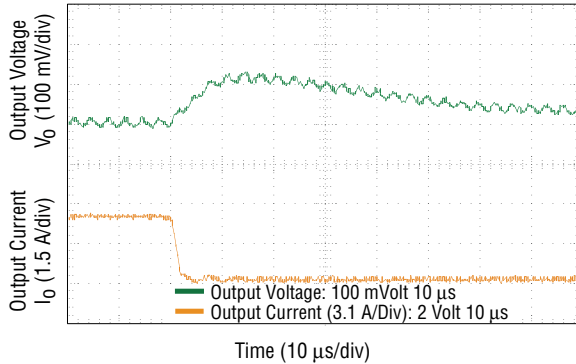

Fig. 13 Transient Response - 10 A - 5 A Step
($V_o = 3.3 V_{dc}$, $C_{ext} = 3 \times 100 \mu F$ Polymer Capacitors)

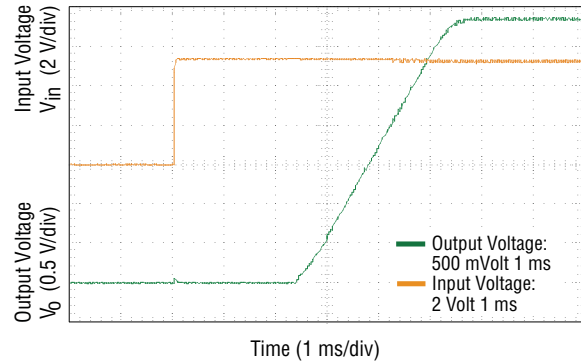

Fig. 16 Typical Start-up with Application of V_{in}
($V_{in} = 5 V_{dc}$, $V_o = 3.3 V_{dc}$, $I_o = 10 A$)

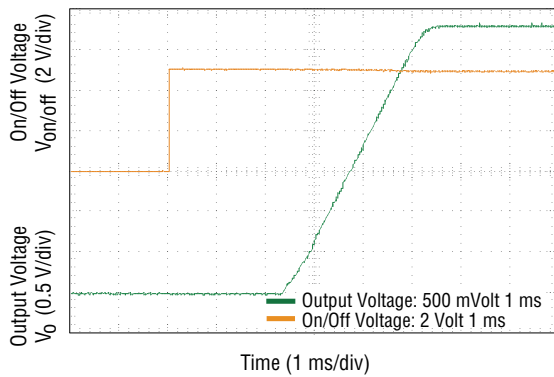

Fig. 14 Typical Start-up using Remote On/Off
($V_{in} = 5 V_{dc}$, $V_o = 3.3 V_{dc}$, $I_o = 10 A$)

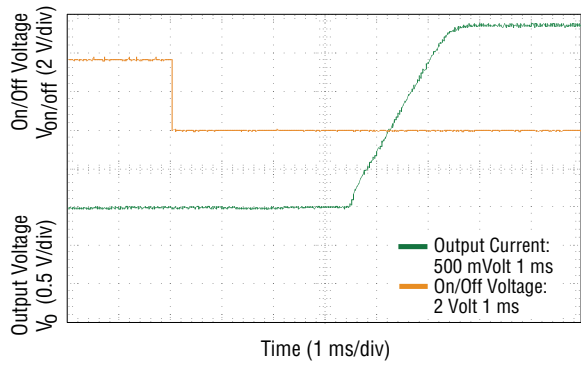

Fig. 17 Typical Start-up using Remote On/Off with Prebias
($V_{in} = 5 V_{dc}$, $V_o = 3.3 V_{dc}$, $I_o = 1 A$, $V_{bias} = 1 V_{dc}$)

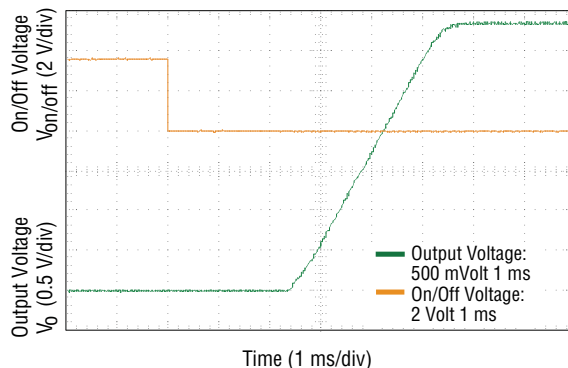

Fig. 15 Typical Start-up using Remote On/Off with Low-ESR External Capacitors (100x100 μF Polymer)
($V_{in} = 5.0 V_{dc}$, $V_o = 3.3 V_{dc}$, $I_o = 10.0 A$, $C_o = 1000 \mu F$)

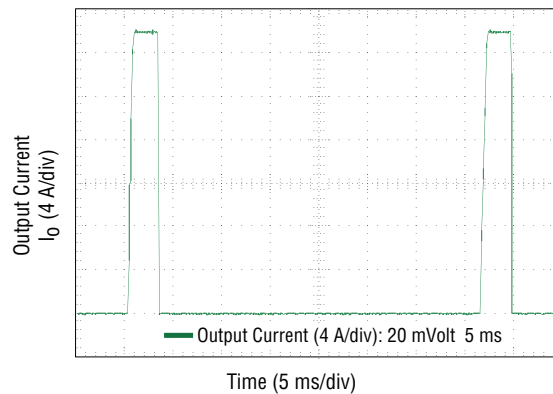

Fig. 18 Output Short Circuit Current
($V_{in} = 5.0 V_{dc}$, $V_o = 0.75 V_{dc}$)

Characteristic Curves (Continued)

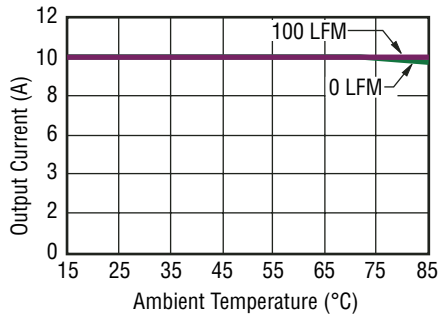

Fig. 19 Derating Output Current vs. Local Ambient Temp. and Airflow
 $(V_{in} = 5.0 V_{dc}, V_o = 0.75 V_{dc})$

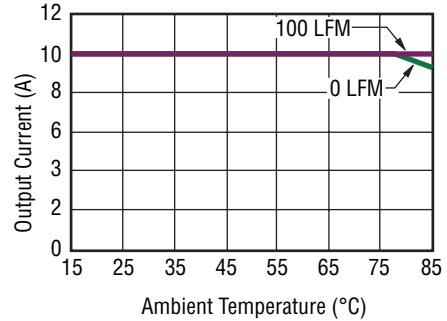

Fig. 22 Derating Output Current vs. Local Ambient Temp. and Airflow
 $(V_{in} = 5.0 V_{dc}, V_o = 3.3 V_{dc})$

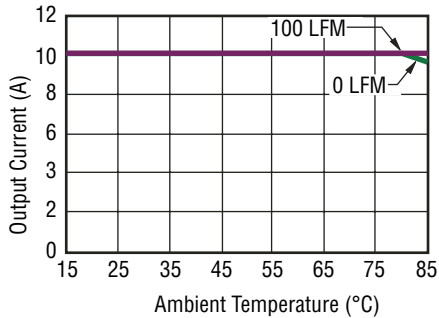

Fig. 20 Derating Output Current vs. Local Ambient Temp. and Airflow
 $(V_{in} = 5.0 V_{dc}, V_o = 1.8 V_{dc})$

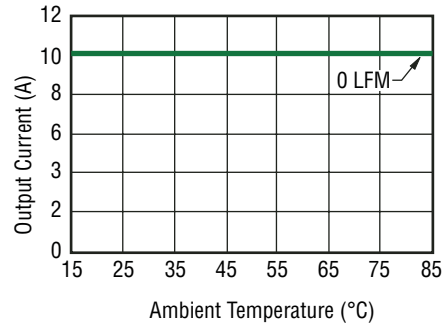

Fig. 23 Derating Output Current vs. Local Ambient Temp. and Airflow
 $(V_{in} = 3.3 V_{dc}, V_o = 2.5 V_{dc})$

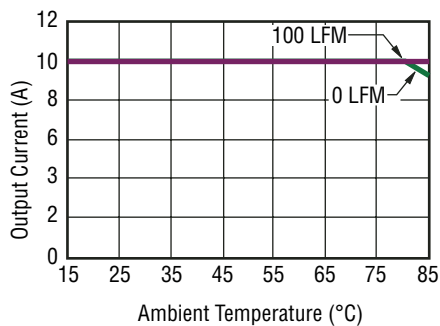

Fig. 21 Derating Output Current vs. Local Ambient Temp. and Airflow
 $(V_{in} = 5.0 V_{dc}, V_o = 2.5 V_{dc})$

Operating Information

Remote On/Off

The SX(T)10A-3-5SA comes standard with Active LOW Negative On/Off logic, i.e., OPEN or LOW (< 0.4 V) will turn ON the device. To turn the device OFF, increase the voltage level on the On/Off pin above 2.4 V, as shown in Figure 24(a), placing the part into low dissipation sleep mode.

The SX(T)10A-3-5SA-P comes with Active HIGH Positive On/Off logic, i.e., OPEN or HIGH (>2.4 V) will turn on the device. To turn OFF, decrease the voltage level on the On/Off pin below 0.4 V.

The signal levels of the On/Off pin input is defined with respect to ground.

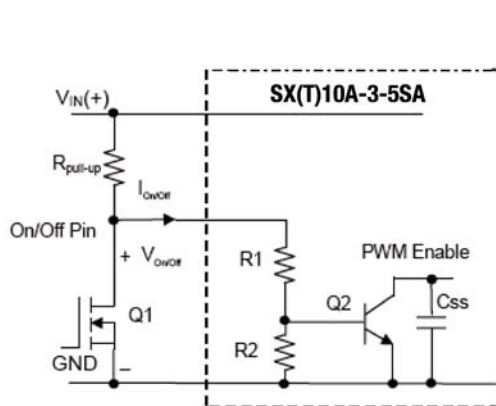

Fig. 24(a) Circuit Configuration for using Negative Logic On/Off

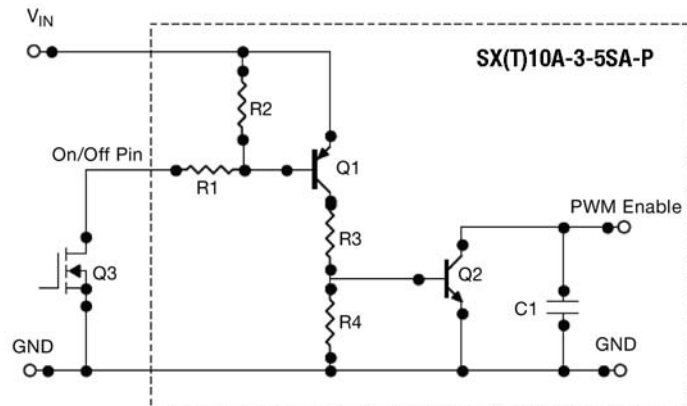

Fig. 24(b) Circuit Configuration for using Positive On/Off

Input Considerations

The input must have a stable low impedance AC source for optimum performance. This can be accomplished with external ceramic capacitors, tantalum capacitors and/or polymer capacitors. Using low impedance tantalum capacitors requires about 20 μF per amp and an ESR of 250 $\text{m}\Omega$ per amp of output current. Tantalum capacitors with a combined value of 200 μF and less than 25 $\text{m}\Omega$ ESR would be adequate. This can be implemented with (2) 100 μF tantalum capacitors with an ESR less than of 50 $\text{m}\Omega$. Ceramic capacitors are also recommended to reduce high frequency ripple on the input.

Output Considerations

To maintain the specified output ripple and transient response, external capacitors must be used. An external 1 μF ceramic capacitor in parallel with a 10 μF low ESR tantalum capacitor will usually meet the specified performance. Improved performance can be achieved by using more capacitance. Low ESR polymer capacitors may also be used. Two 100 μF , 9 $\text{m}\Omega$ or lower ESR capacitors are recommended.

Safety Information

In order to comply with safety requirements the user must provide a fuse in the unearthed input line. This is to prevent earth being disconnected in the event of a failure.

The converter must be installed as per guidelines outlined by the various safety approvals if safety agency approval is required for the overall system. The positive input lead must be provided with a time-delay fuse with a maximum rating of 15 A.

Overtemperature Protection

The device will shut down if it becomes too hot (typically 125 $^{\circ}\text{C}$). Once the converter cools, it automatically restarts. This feature does not guarantee the converter won't be damaged by temperatures above its rating.

Operating Information (Continued)

Overcurrent Protection

The device has an internally set output current limit to protect it from overloads, placing the unit in hiccup mode. Once the overload is removed the converter automatically resumes normal operation. No user adjustments are available. An external fuse in series with the input voltage is also required for complete overload protection.

Input Undervoltage Lockout

The device operation is disabled if the input voltage drops below the specified input range. Once the input returns to the specified range operation automatically resumes. No user adjustments are available.

Output Voltage Setting

The output voltage can be programmed to any voltage between 0.75 Vdc and 3.3 Vdc by connecting a single resistor between the trim pin and the GND pin of the module, as shown in Fig. 25 below.

If left open circuit the output voltage will default to 0.75 Vdc. The correct Rtrim value for a specific voltage can be calculated using the following equation:

$$R_{trim} = [21.07 / (V_o - 0.7525) - 5.11] \text{ K}\Omega$$

For example, to set the SX(T)10A-3-5SA to 3.3 V the following Rtrim resistor must be used:

$$R_{trim} = [21.07 / (3.3 - 0.7525) - 5.11] \text{ K}\Omega$$

$$R_{trim} = 3.161 \text{ k}\Omega,$$

The closest standard 1 % E96 value is 3.16 kΩ.

Table 1 provides the Rtrim values required for some common output voltage set points. The nearest standard E96 1 % resistor value is also given.

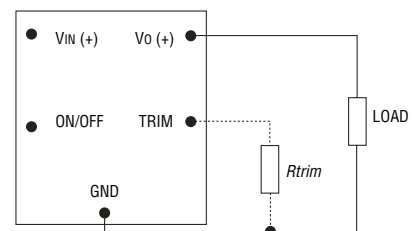

Fig. 25 Circuit Configuration to Program Output Voltage using an External Resistor

SX(T)10A-3-5SA Rtrim Values		
Vo (V)	Rtrim (kΩ)	1 % Value
0.75	Open	Open
1.0	80.02	80.6
1.2	41.97	42.2
1.5	23.08	23.2
1.8	15.00	15.0
2.0	11.78	11.8
2.5	6.947	6.98
3.3	3.161	3.16

Table 1

The output voltage of the device can also be set by applying a voltage between the TRIM and GND pins. The Vtrim equation can be written as follows:

$$V_{trim} = (0.7 - 0.1698 \times (V_o - 0.7225))$$

To set Vo = 3.3 V, the Vtrim required would therefore be 0.2670 V.

Table 2 provides the Vtrim values required for some common output voltage set points.

Operating Information (Continued)

SX(T)10A-3-5SA Vtrim Values	
Vo (V)	Vtrim (V)
0.75	Open
1.0	0.6580
1.2	0.6240
1.5	0.5731
1.8	0.5221
2.0	0.4882
2.5	0.4033
3.3	0.2674

Table 2

Voltage Margining

Output voltage margining can be implemented as follows and as shown in Figure 26.

- 1) Trim-up: Connect a resistor, R_{m-up} , from the Trim pin to the ground pin for adjusting the voltage upwards, and
- 2) Trim-down: Connect a resistor, R_{m-down} , from the Trim pin to the output pin for adjusting the voltage downwards.

Please consult your local Bourns field applications engineer for more details and the calculation of the required resistor values.

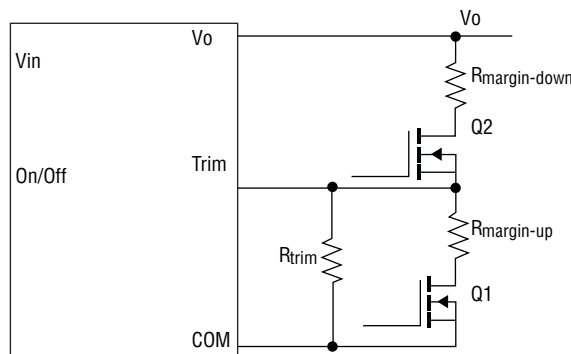

Fig. 26 Circuit Configuration for Margining Output Voltage

Sequencing Function

Bourns XT Series modules have a sequencing feature that enables users to implement various types of output voltage sequencing in their applications. When an analog voltage is applied to the SEQ pin, the output voltage tracks this voltage until the output reaches the set-point voltage. The final SEQ pin voltage must be set higher than the set-point voltage of the module. The output voltage follows the voltage on the SEQ pin on a one-to-one basis. By connecting multiple modules together, customers can get multiple modules to track their output voltages to the voltage applied on the SEQ pin.

For proper voltage sequencing, the input voltage is applied to the module. The On/Off pin should be set so as the module is ON by default. An analog voltage is applied to the SEQ pin and the output voltage of the module will track this voltage on a 1:1 basis until output reaches the set-point voltage, as shown in Figure 27.

To initiate simultaneous shutdown of the modules, the SEQ pin voltage is lowered in a controlled manner. Output voltage of the modules tracks the voltages below their set-point voltages on a one-to-one basis, as shown in Figure 28. A valid input voltage must be maintained until the tracking and output voltages reach ground potential to ensure a controlled shutdown of the modules.

When not using the sequencing feature, tie the SEQ pin to V_{OUT} . For additional guidelines please contact your local Bourns field applications engineer.

Operating Information (Continued)

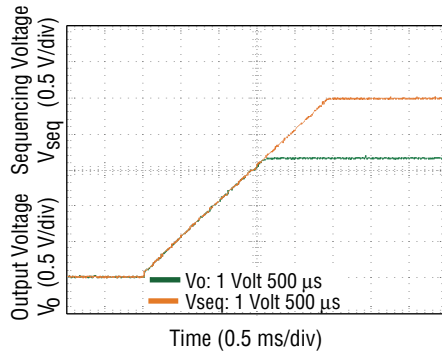

Fig. 27 Voltage Sequencing at Power Up
 ($V_{in} = 5.0 V_{dc}$, $V_O = 3.3 V_{dc}$, $I_O = 10.0 A$)

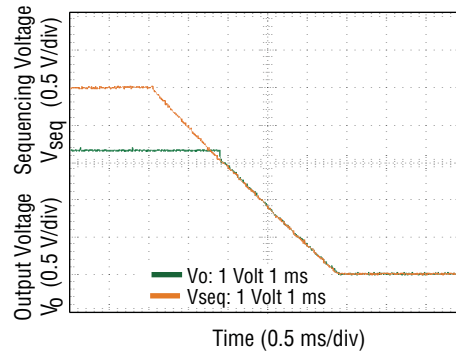

Fig. 28 Voltage Sequencing at Power Down
 ($V_{in} = 5.0 V_{dc}$, $V_O = 3.3 V_{dc}$, $I_O = 10.0 A$)

Remote Sense

The Remote Sense feature is used to minimize the effects of distribution losses by regulating the voltage at the Remote Sense pin (See Figure 29). The voltage between the Sense pin and V_O pin must not exceed 0.5 V.

When the Remote Sense feature is not being used, connect the Remote Sense pin to the output pin of the module.

It is very important to make sure that the maximum output power ($V_O \times I_O$) of the module remains less than or equal to the maximum rated power. Using Remote Sense, the output voltage of the module can increase, which may increase the power output by the module.

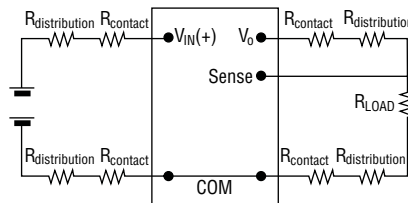

Fig. 29 Remote Sense Circuit Configuration

Thermal Considerations

Sufficient cooling must always be considered to ensure reliable operation, as these devices operate in a variety of thermal environments.

Factors such as ambient temperature, airflow, power dissipation and reliability must be taken into consideration.

The data presented in Figures 19 to 23 is based on physical test results taken in a wind tunnel test. The test set-up is shown in Figure 31.

The thermal reference points are (1) T_{ref1} and T_{ref2} as shown in Figure 30, and (2) T_{ref3} = temperature at controller IC. For reliable operation, none of these T_{ref} points should exceed 115 °C.

SX(T)10A-3-5SA SIP Non-Isolated Power Module

BOURNS®

Thermal Considerations (Continued)

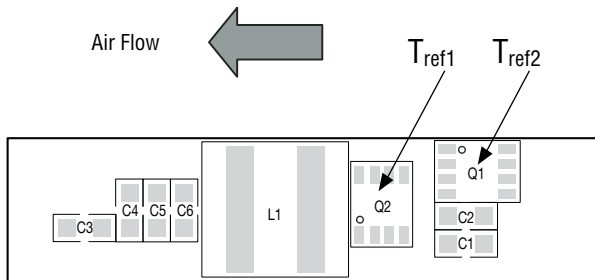

Fig. 30 T_{ref1} Temperature Measurement Location

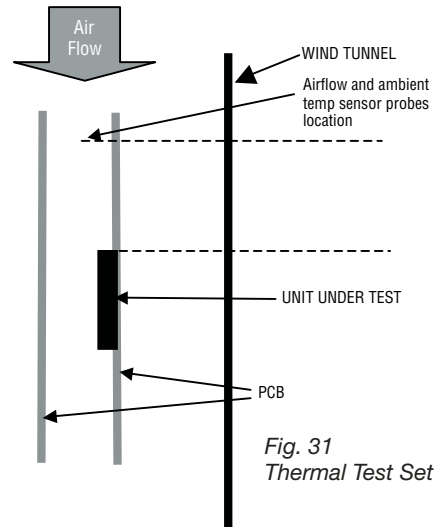

Fig. 31 Thermal Test Set-up

Product Dimensions

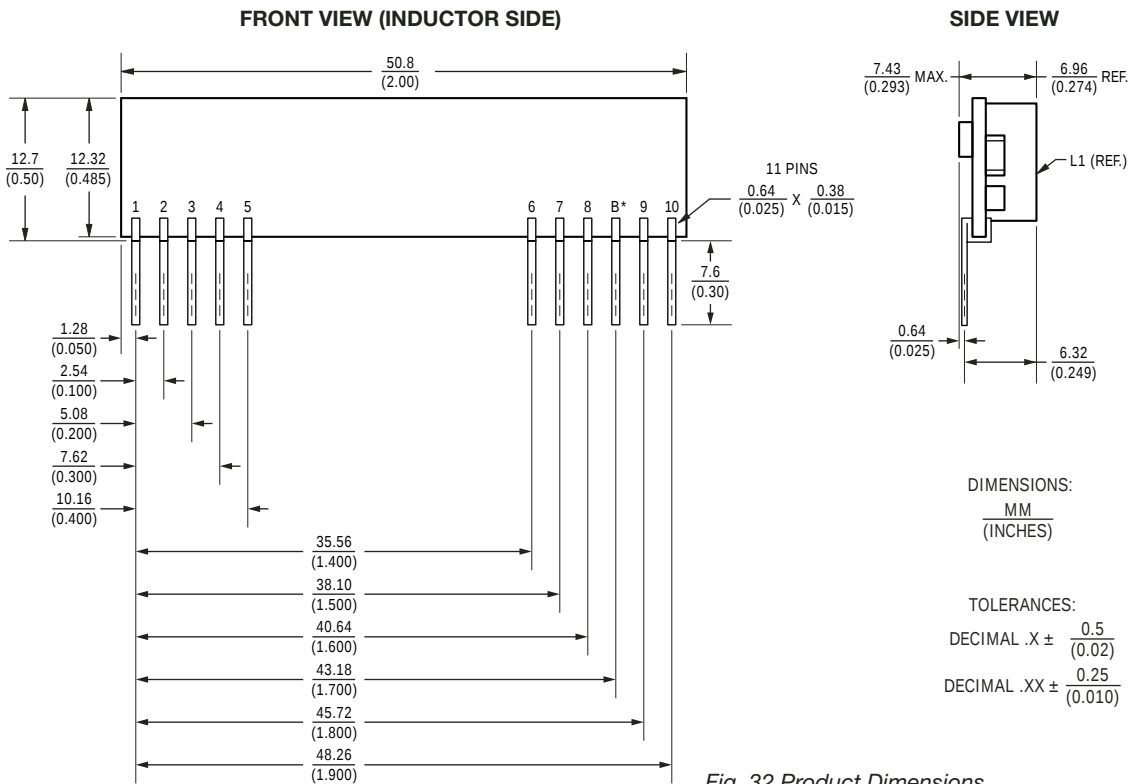

Fig. 32 Product Dimensions

*Pin Stuffed with SXT10A option only, absent with SX10A standard

Specifications are subject to change without notice. Customers should verify device performance in their specific applications.

SX(T)10A-3-5SA SIP Non-Isolated Power Module



Recommended Hole Pattern

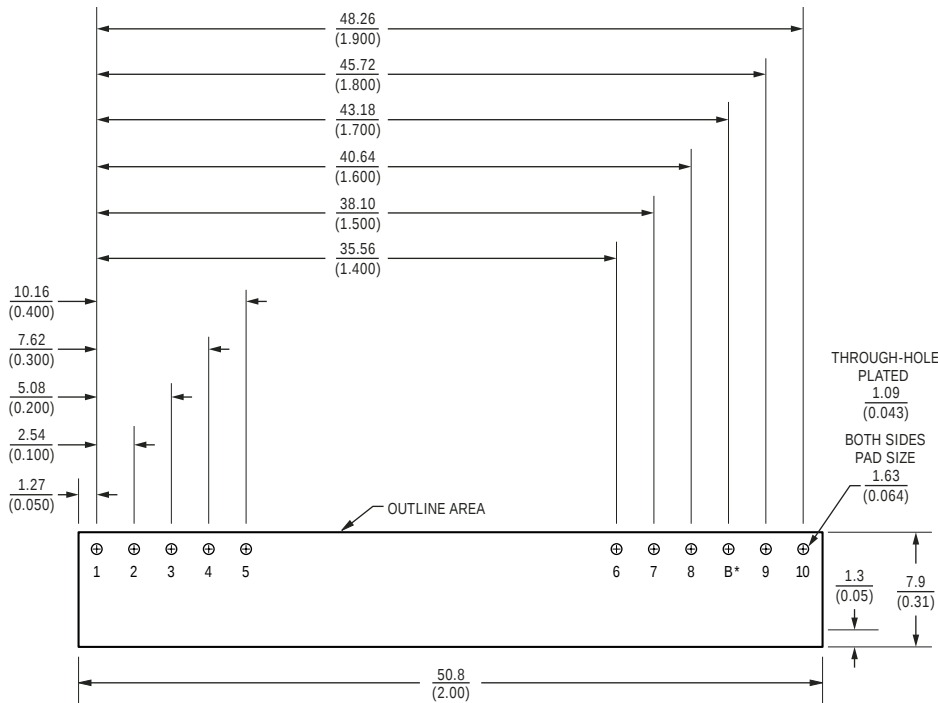

PIN	FUNCTION
1	VOUT
2	VOUT
3	SENSE
4	VOUT
5	GND
6	GND
7	VIN
8	VIN
B (optional)	SEQ
9	TRIM
10	ON/OFF

DIMENSIONS:
MM
(INCHES)

*Hole required with SXT10A option only, not required with SX10A standard

Fig. 33 Recommended Hole Pattern



Reliable Electronic Solutions

Asia-Pacific: Tel: +886-2 2562-4117 • Fax: +886-2 2562-4116
Europe: Tel: +41-41 768 5555 • Fax: +41-41 768 5510
The Americas: Tel: +1-951 781-5500 • Fax: +1-951 781-5700
www.bourns.com