

TIP36, TIP36A, TIP36B, TIP36C PNP SILICON POWER TRANSISTORS

Copyright © 1997, Power Innovations Limited, UK

JULY 1968 - REVISED MARCH 1997

- Designed for Complementary Use with the TIP35 Series
- 125 W at 25°C Case Temperature
- 25 A Continuous Collector Current
- 40 A Peak Collector Current
- Customer-Specified Selections Available

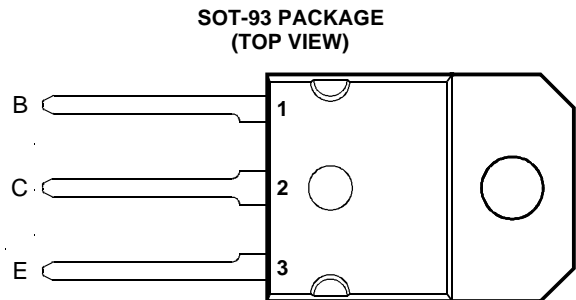

Pin 2 is in electrical contact with the mounting base.

MDTRAA

absolute maximum ratings at 25°C case temperature (unless otherwise noted)

RATING		SYMBOL	VALUE	UNIT
Collector-base voltage ($I_E = 0$)	TIP36	V_{CBO}	-80	V
	TIP36A		-100	
	TIP36B		-120	
	TIP36C		-140	
Collector-emitter voltage ($I_B = 0$)	TIP36	V_{CEO}	-40	V
	TIP36A		-60	
	TIP36B		-80	
	TIP36C		-100	
Emitter-base voltage		V_{EBO}	-5	V
Continuous collector current		I_C	-25	A
Peak collector current (see Note 1)		I_{CM}	-40	A
Continuous base current		I_B	-5	A
Continuous device dissipation at (or below) 25°C case temperature (see Note 2)		P_{tot}	125	W
Continuous device dissipation at (or below) 25°C free air temperature (see Note 3)		P_{tot}	3.5	W
Unclamped inductive load energy (see Note 4)		$\frac{1}{2}LI_C^2$	90	mJ
Operating junction temperature range		T_j	-65 to +150	°C
Storage temperature range		T_{stg}	-65 to +150	°C
Lead temperature 3.2 mm from case for 10 seconds		T_L	250	°C

NOTES: 1. This value applies for $t_p \leq 0.3$ ms, duty cycle $\leq 10\%$.

2. Derate linearly to 150°C case temperature at the rate of 1 W/°C.

3. Derate linearly to 150°C free air temperature at the rate of 28 mW/°C.

4. This rating is based on the capability of the transistor to operate safely in a circuit of: $L = 20$ mH, $I_{B(on)} = -0.4$ A, $R_{BE} = 100 \Omega$, $V_{BE(off)} = 0$, $R_S = 0.1 \Omega$, $V_{CC} = -20$ V.

PRODUCT INFORMATION

Information is current as of publication date. Products conform to specifications in accordance with the terms of Power Innovations standard warranty. Production processing does not necessarily include testing of all parameters.



TIP36, TIP36A, TIP36B, TIP36C

PNP SILICON POWER TRANSISTORS

JULY 1968 - REVISED MARCH 1997

electrical characteristics at 25°C case temperature

PARAMETER	TEST CONDITIONS			MIN	TYP	MAX	UNIT
$V_{(BR)CEO}$ Collector-emitter breakdown voltage	$I_C = -30 \text{ mA}$ (see Note 5)	$I_B = 0$	TIP36 TIP36A TIP36B TIP36C	-40 -60 -80 -100			V
I_{CES} Collector-emitter cut-off current	$V_{CE} = -80 \text{ V}$ $V_{CE} = -100 \text{ V}$ $V_{CE} = -120 \text{ V}$ $V_{CE} = -140 \text{ V}$	$V_{BE} = 0$ $V_{BE} = 0$ $V_{BE} = 0$ $V_{BE} = 0$	TIP36 TIP36A TIP36B TIP36C			-0.7 -0.7 -0.7 -0.7	mA
I_{CEO} Collector cut-off current	$V_{CE} = -30 \text{ V}$ $V_{CE} = -60 \text{ V}$	$I_B = 0$ $I_B = 0$	TIP36/36A TIP36B/36C			-1 -1	mA
I_{EBO} Emitter cut-off current	$V_{EB} = -5 \text{ V}$	$I_C = 0$				-1	mA
h_{FE} Forward current transfer ratio	$V_{CE} = -4 \text{ V}$ $V_{CE} = -4 \text{ V}$	$I_C = -1.5 \text{ A}$ $I_C = -15 \text{ A}$	(see Notes 5 and 6)	25 10		50	
$V_{CE(sat)}$ Collector-emitter saturation voltage	$I_B = -1.5 \text{ A}$ $I_B = -5 \text{ A}$	$I_C = -15 \text{ A}$ $I_C = -25 \text{ A}$	(see Notes 5 and 6)			-1.8 -4	V
V_{BE} Base-emitter voltage	$V_{CE} = -4 \text{ V}$ $V_{CE} = -4 \text{ V}$	$I_C = -15 \text{ A}$ $I_C = -25 \text{ A}$	(see Notes 5 and 6)			-2 -4	V
h_{fe} Small signal forward current transfer ratio	$V_{CE} = -10 \text{ V}$	$I_C = -1 \text{ A}$	$f = 1 \text{ kHz}$	25			
$ h_{fe} $ Small signal forward current transfer ratio	$V_{CE} = -10 \text{ V}$	$I_C = -1 \text{ A}$	$f = 1 \text{ MHz}$	3			

NOTES: 5. These parameters must be measured using pulse techniques, $t_p = 300 \mu\text{s}$, duty cycle $\leq 2\%$.

6. These parameters must be measured using voltage-sensing contacts, separate from the current carrying contacts.

thermal characteristics

PARAMETER	MIN	TYP	MAX	UNIT
$R_{\theta JC}$ Junction to case thermal resistance			1	°C/W
$R_{\theta JA}$ Junction to free air thermal resistance			35.7	°C/W

resistive-load-switching characteristics at 25°C case temperature

PARAMETER	TEST CONDITIONS †			MIN	TYP	MAX	UNIT
t_{on} Turn-on time	$I_C = -15 \text{ A}$	$I_{B(on)} = -1.5 \text{ A}$	$I_{B(off)} = 1.5 \text{ A}$		1.1		μs
t_{off} Turn-off time	$V_{BE(off)} = 4.15 \text{ V}$	$R_L = 2 \Omega$	$t_p = 20 \mu\text{s}$, dc $\leq 2\%$		0.8		μs

† Voltage and current values shown are nominal; exact values vary slightly with transistor parameters.

TYPICAL CHARACTERISTICS

TYPICAL DC CURRENT GAIN
VS
COLLECTOR CURRENT

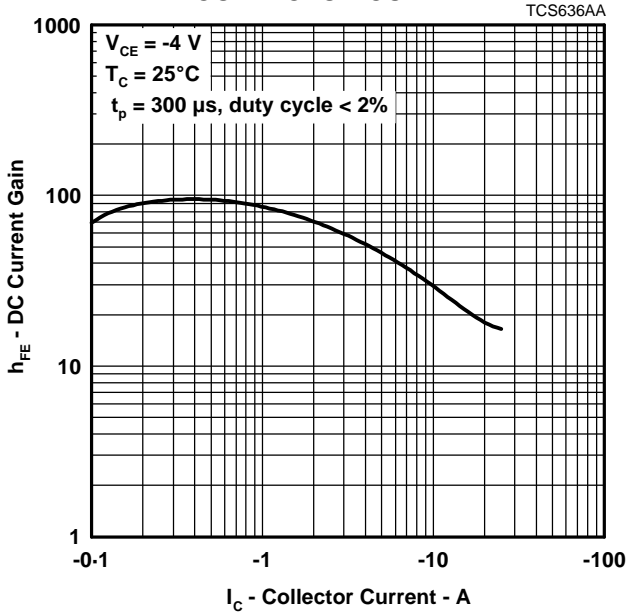

Figure 1.

COLLECTOR-EMITTER SATURATION VOLTAGE
VS
BASE CURRENT

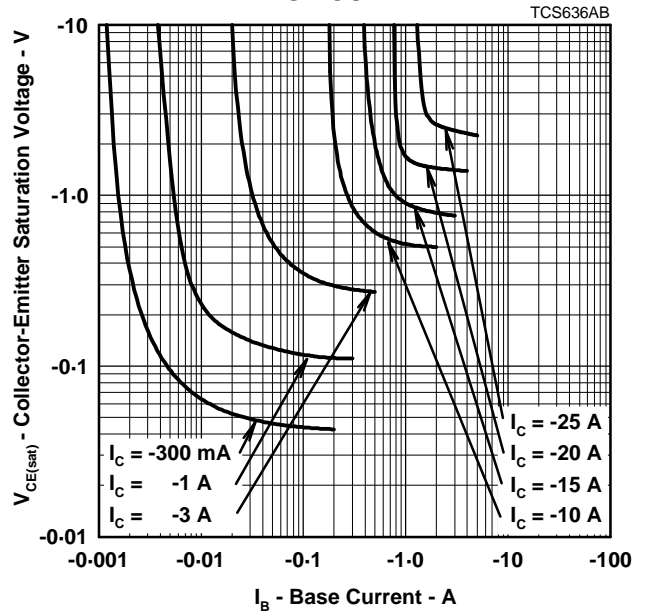

Figure 2.

BASE-EMITTER VOLTAGE
VS
COLLECTOR CURRENT

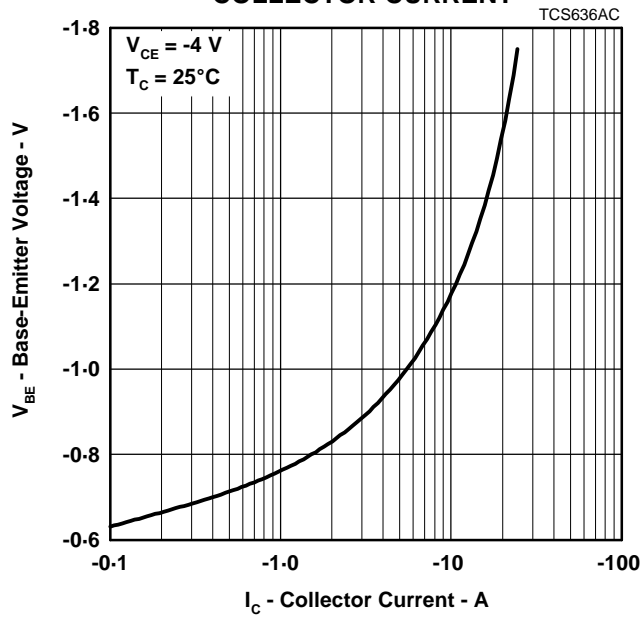
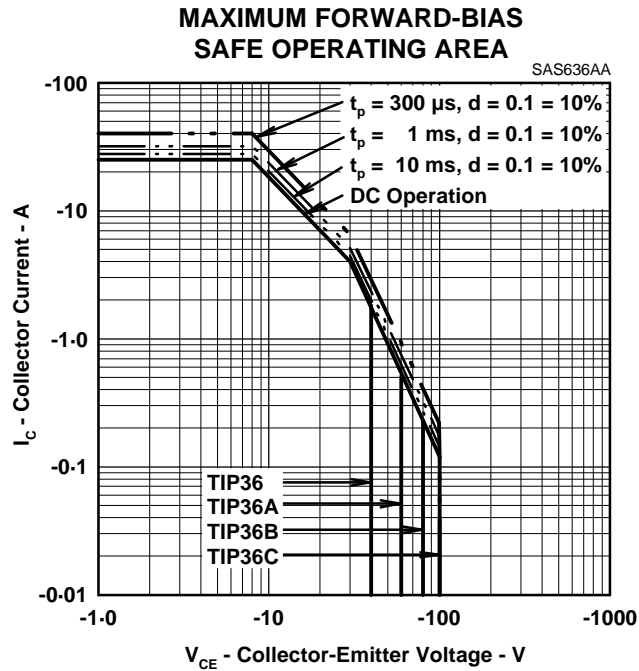

Figure 3.

TIP36, TIP36A, TIP36B, TIP36C PNP SILICON POWER TRANSISTORS

JULY 1968 - REVISED MARCH 1997

MAXIMUM SAFE OPERATING REGIONS



THERMAL INFORMATION

MAXIMUM POWER DISSIPATION vs CASE TEMPERATURE

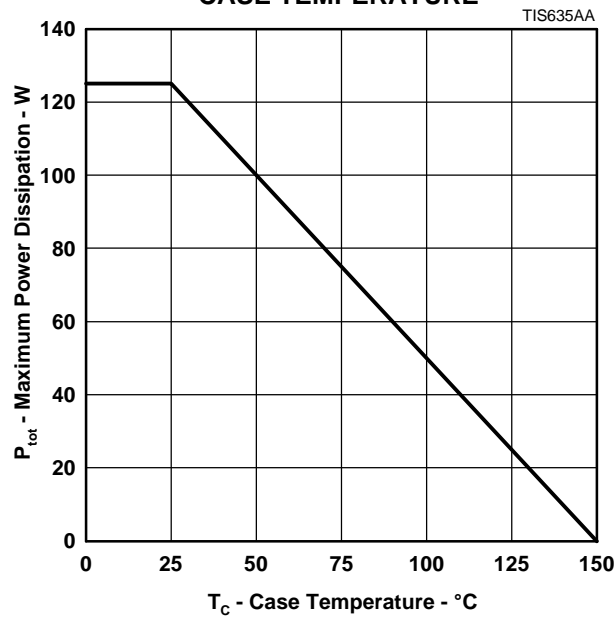

MECHANICAL DATA

SOT-93

3-pin plastic flange-mount package

This single-in-line package consists of a circuit mounted on a lead frame and encapsulated within a plastic compound. The compound will withstand soldering temperature with no deformation, and circuit performance characteristics will remain stable when operated in high humidity conditions. Leads require no additional cleaning or processing when used in soldered assembly.

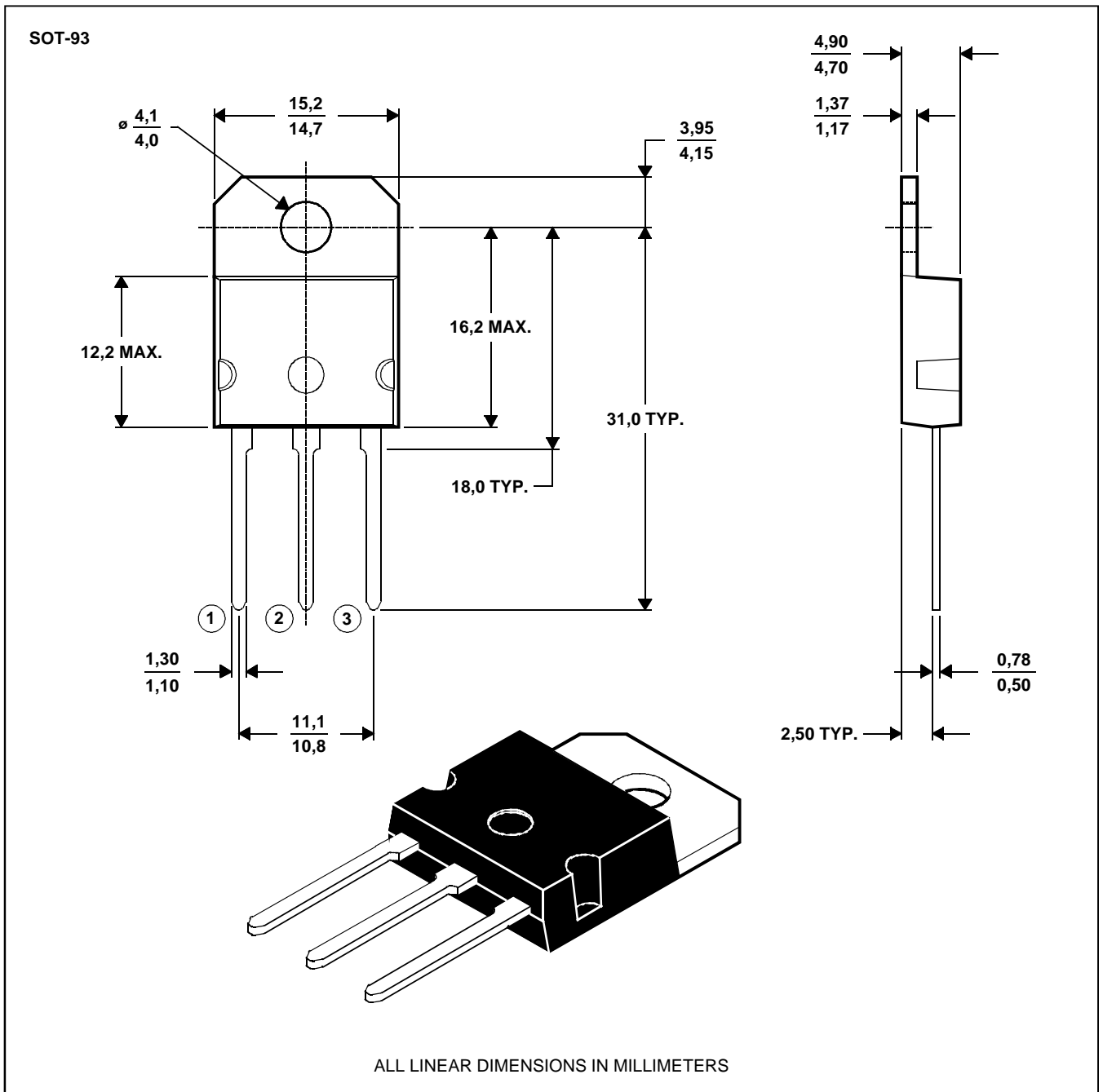

NOTE A: The centre pin is in electrical contact with the mounting tab.

MDXXAW

TIP36, TIP36A, TIP36B, TIP36C

PNP SILICON POWER TRANSISTORS

JULY 1968 - REVISED MARCH 1997

IMPORTANT NOTICE

Power Innovations Limited (PI) reserves the right to make changes to its products or to discontinue any semiconductor product or service without notice, and advises its customers to verify, before placing orders, that the information being relied on is current.

PI warrants performance of its semiconductor products to the specifications applicable at the time of sale in accordance with PI's standard warranty. Testing and other quality control techniques are utilized to the extent PI deems necessary to support this warranty. Specific testing of all parameters of each device is not necessarily performed, except as mandated by government requirements.

PI accepts no liability for applications assistance, customer product design, software performance, or infringement of patents or services described herein. Nor is any license, either express or implied, granted under any patent right, copyright, design right, or other intellectual property right of PI covering or relating to any combination, machine, or process in which such semiconductor products or services might be or are used.

PI SEMICONDUCTOR PRODUCTS ARE NOT DESIGNED, INTENDED, AUTHORIZED, OR WARRANTED TO BE SUITABLE FOR USE IN LIFE-SUPPORT APPLICATIONS, DEVICES OR SYSTEMS.

Copyright © 1997, Power Innovations Limited