



DP SERIES

SWITCHING TRANSIENT FILTERS



INTRODUCTION

Two-stage filters provide high insertion loss for both line-to-line and line-to-ground emissions throughout the frequency range.

COMPONENTS

PART NO.	C1 (uF)	C2 (uF)	L1 (mH)	L2 (mH)
03DPCG5S	0.33	0.33	10	10
03DPCW5S				
03DPDG3S			6.5	4.5
03DPDW3S				
06DPCG5	0.47	0.47	2.7	14
06DPCW5				
06DPDW3			0.8	2.83
10DPCG5				

PART NO.	C1 (uF)	C2 (pF)	L1 (mH)	L2 (mH)	R (K)
03DPCG5B/W5B	0.47	4700	9.8	9.8	470
06DPCG5B/W5B	1.0		7.8	7.8	220
12DPCG5B/W5B			3.25	3.25	
16DPGG5B/W5B/S5B			2.8	2.8	

PART NO.	Cx (uF)	L1 (mH)	L2 (mH)	Cy (pF)	R (Ohm)
03DPCG5C	0.22	2.5	2.5	4700	1.0M
03DPCW5C					
06DPCG5C		0.97	0.97		
06DPCW5C					
12DPCG5C	0.47	0.58	0.58		470K
12DPCW5C					
16DPCG5C	0.33	0.65	0.65		1.0M
16DPCW5C					
16DPCS5C		1.0	0.60	0.60	
20DPCG5C					
20DPCS5C					
30DPCG5C				10000	

ELECTRICAL SCHEMATIC

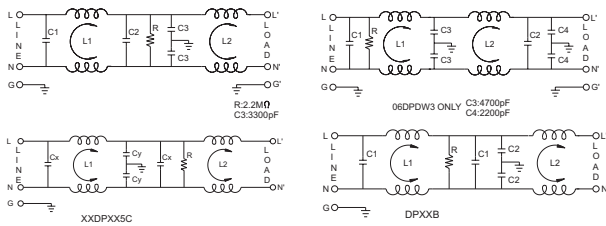

SPECIFICATIONS

- Maximum leakage current each
line-to-ground @ 115VAC 60Hz: 0.4mA (4700pF)
@ 250VAC 50Hz: 0.8mA (4700pF)
@ 115VAC 60Hz: 1.0mA (10000pF)
@ 250VAC 50Hz: 2.0mA (10000pF)
- Hipot rating (one minute)
line-to-ground: 2250VDC
line-to-line: 1450VDC
- Operating frequency: 50/60Hz
- Rated voltage: 115/250VAC

MINIMUM INSERTION LOSS IN dB

COMMON MODE (L-G) IN 50 OHM SYSTEM						
CURRENT RATING	FREQUENCY-MHz					
	.15	.50	1.0	5.0	10	30
3A(S)	50	70	70	60	55	40
3A	60	70	70	65	55	40
6A	58	70	70	70	60	50
10A	58	70	70	70	70	30
•06DPDW3	60	70	70	65	70	60
03DPCG5B/W5B	60	70	70	65	70	60
06DPCG5B/W5B	50	60	60	60	60	35
12DPCG5B/W5B	45	60	65	65	65	45
16DPGG5B/W5B/S5B	20	35	40	50	40	30
DIFFERENTIAL MODE (L-L) IN 50 OHM SYSTEM						
3A(S)	35	48	55	55	55	45
3A	36	55	60	55	55	45
6A	40	65	65	70	70	50
10A	45	65	65	70	70	50
03DPCG5B/W5B	30	45	45	45	45	25
•06DPDW3	40	60	60	60	60	60
06DPCG5B/W5B	45	50	50	55	55	45
12DPCG5B/W5B	45	45	50	50	50	50
16DPGG5B/W5B/S5B	7	55	50	50	50	40

- Maximum leakage current
 - 115VAC 60Hz: 0.5mH
 - 250VAC 50Hz: 1.0mH

COMMON MODE (L-G) IN 50 OHM SYSTEM							
CURRENT RATING	STYLE	FREQUENCY-MHz					
		.15	.50	1.0	5.0	10	30
3A	CG5C, CW5C	45	60	60	55	45	45
6A	CG5C, CW5C	30	50	60	55	50	35
12A	CG5C, CW5C	15	25	35	55	55	35
16A	CG5C, CW5C, CS5C	20	35	45	60	50	35
20A	CG5C, CS5C	15	40	45	50	50	40
30A	CS5C	10	30	35	55	45	30
DIFFERENTIAL MODE (L-L) IN 50 OHM SYSTEM							
3A	CG5C, CW5C	12	45	45	45	45	45
6A	CG5C, CW5C	8	45	45	45	45	45
12A	CG5C, CW5C	12	40	40	35	35	40
16A	CG5C, CW5C, CS5C	12	40	40	45	45	50
20A	CG5C, CS5C	12	45	45	40	35	50
30A	CS5C	18	45	50	40	40	40

GENERAL PURPOSE TWO-STAGE FILTERS

SERIES DIMENSIONS

CURRENT RATING	DIMENSIONS IN INCHES/mm									
	STYLE	A	B	C	D	E				
3A	CG5S	3.75	2.04 51.8	1.77 45.0	2.94 74.7	3.34 84.8				
		95.2								
3A	CW5S	2.53								
		64.8								
3A	DG3S	3.14								
		79.5								
3A	DW3S	2.55								
		64.8								
6A	CG5	6.50					2.04 51.8	2.27 57.7	5.63 143.0	6.04 153.4
		165.1								
6A	CW5	5.27								
		133.9								
10A	CG5	6.50								
		165.1								
6A	DW3	3.10	1.77 45.0	1.575 40.01	0.63 16.0					
		78.7								

CURRENT RATING	DIMENSIONS IN INCHES/mm							
	STYLE	A	B	C	D	E	F	G
3A	CG5B, CW5B	2.95 75.0	3.34 84.8	2.05 52.0	2.58 65.6	1.54 39.2	—	—
6A	CG5B, CW5B	4.06 103.0	4.49 114.0	2.22 56.5	3.76 95.5	1.83 46.4	—	—
12A	CG5B, CW5B	5.63 143.0	6.02 152.9	2.05 52.0	5.30 134.7	1.78 45.3	—	—
16A	GG5B, CW5B, CS5B	3.90 99.0	4.31 109.5	4.72 120.0	2.01 51.0	2.62 66.5	3.39 86.0	2.28 58.0

CURRENT RATING	DIMENSIONS IN INCHES/mm														
	STYLE	A	B	C	D	E	F	G							
3A	CG5C, CW5C	2.40 61.00	2.81 71.5	1.79 45.5	2.02 51.3	1.18 30.0	3.94 100.0	—							
									—						
6A	CG5C, CW5C														
									—						
12A	CG5C, CW5C														
									—						
16A	CG5C, CW5C, CS5C								2.95 75.00	3.34 84.8	2.04 51.8	2.52 64.0	1.54 39.2	3.94 100.0	—
									—						
20A	CG5C, CW5C								4.06 103.00	4.49 114.0	2.22 56.5	3.74 95.0	1.83 46.4	—	—
30A	CS5C								3.90 99.0	4.31 109.5	4.72 120.0	2.01 51.0	2.62 66.5	3.39 86.0	2.28 58.0

INSERTION LOSS (TYPICAL)

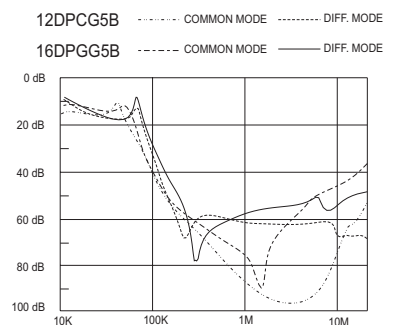
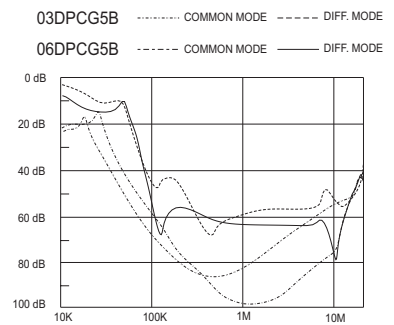
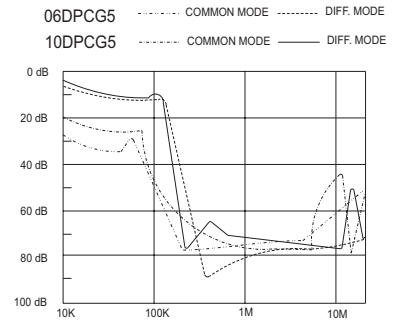
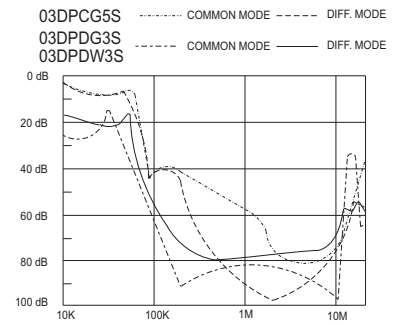

MECHANICAL CONSTRUCTION



CG5S/CG5B/CG5C

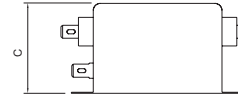
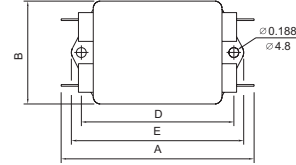

CG5

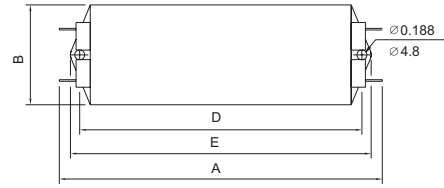

DG3S

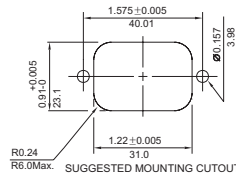
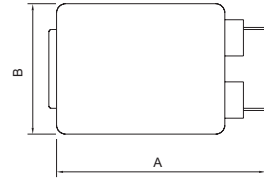
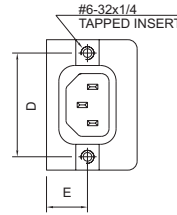

DW3/DW3S

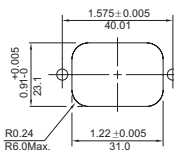
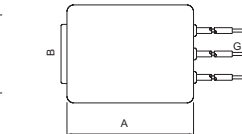
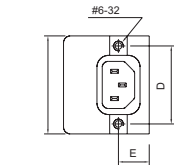

ALL WIRE LEADS 4.0" LONG MIN.



GS5B/GS5C

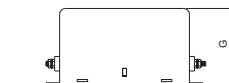
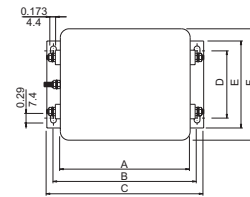

MECHANICAL CONSTRUCTION

GG5B

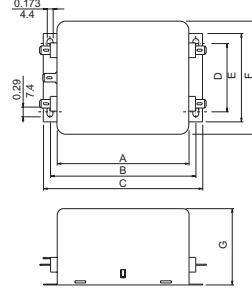

GW5B

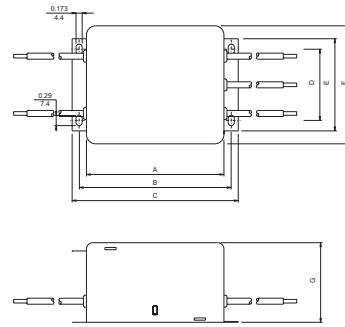

ALL WIRE LEADS 4.0" LONG MIN.

CG5B/CG5C

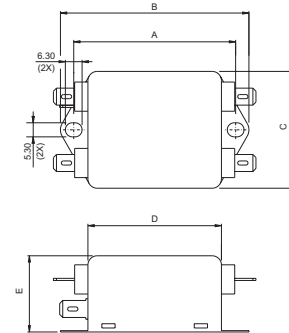

CW5B/CW5S/CW5C

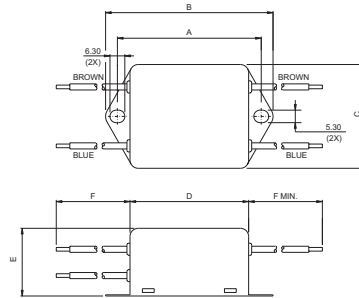
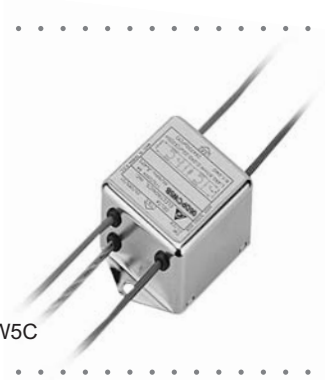

ALL WIRE LEADS 4.0" LONG MIN.

CS5C

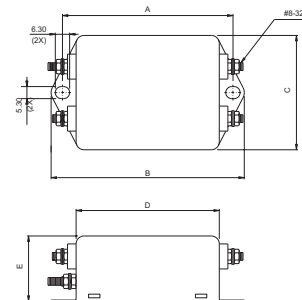

UNIT: $\frac{\text{INCH}}{\text{mm}}$