



Micro Commercial Components  
21201 Itasca Street Chatsworth  
CA 91311  
Phone: (818) 701-4933  
Fax: (818) 701-4939

# BC817-16 THRU BC817-40

## NPN Small Signal Transistor 310mW

### Features

- Ideally Suited for Automatic Insertion
- 150°C Junction Temperature
- For Switching and AF Amplifier Applications
- Epitaxial Planar Die Construction

### Mechanical Data

- Case: SOT-23, Molded Plastic
- Terminals: Solderable per MIL-STD-202, Method 208
- Polarity: See Diagram
- Weight: 0.008 grams ( approx.)
- Marking: BC817-16           6A  
                  BC817-25       6B  
                  BC817-40       6C

Maximum Ratings @ 25°C Unless Otherwise Specified

Charateristic	Symbol	Value	Unit
Collector-Emitter Voltage	$V_{CEO}$	45	V
Emitter-Base Voltage	$V_{EBO}$	5	V
Collector Current	$I_C$	800	mA
Peak Collector Current	$I_{CM}$	1000	mA
Peak Emitter Current	$I_{EM}$	1000	mA
Power Dissipation @ $T_s=50^\circ\text{C}$ (Note1)	$P_d$	310	mW
Operating & Storage Temperature	$T_j, T_{STG}$	-55~150	°C

**Note:** 1. Device mounted on Ceramic Substrate 0.7mm X 2.5cm<sup>2</sup> area

### SOT-23

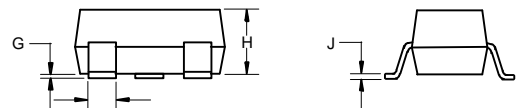
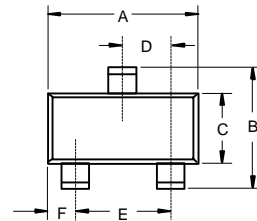

DIM	INCHES		MM		NOTE
	MIN	MAX	MIN	MAX	
A	.110	.120	2.80	3.04	
B	.083	.098	2.10	2.64	
C	.047	.055	1.20	1.40	
D	.035	.041	.89	1.03	
E	.070	.081	1.78	2.05	
F	.018	.024	.45	.60	
G	.0005	.0039	.013	.100	
H	.035	.044	.89	1.12	
J	.003	.007	.085	.180	
K	.015	.020	.37	.51	

### Suggested Solder Pad Layout

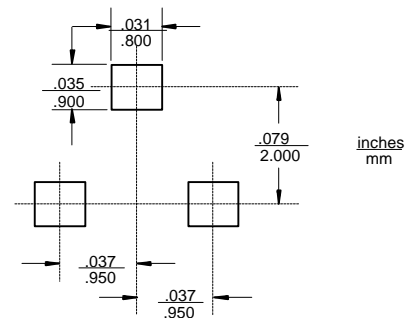

# BC817-16 thru BC817-40

## Electrical Characteristics

@25°C unless otherwise specified

Characteristic	Symbol	Min	Max	Unit	Test Condition
DC Current Gain	Current Gain Group -16 -25 -40	100	250	—	$V_{CE} = 1.0V, I_C = 100mA$
		160	400		$V_{CE} = 1.0V, I_C = 300mA$
	Current Gain Group -16 -25 -40	250 60 100 170	600 — — —		
Thermal Resistance, Junction to Substrate Backside	$R_{\theta SB}$	—	320	K/W	Note 1
Thermal Resistance, Junction to Ambient Air	$R_{\theta JA}$	—	400	K/W	Note 1
Collector-Emitter Saturation Voltage	$V_{CE(SAT)}$	—	0.7	V	$I_C = 500mA, I_B = 50mA$
Base-Emitter Voltage	$V_{BE}$	—	1.2	V	$V_{CE} = 1.0V, I_C = 300mA$
Collector-Emitter Cutoff Current	$I_{CES}$	—	100	nA	$V_{CE} = 45V$
			5.0	$\mu A$	$V_{CE} = 25V, T_J = 150^\circ C$
Emitter-Base Cutoff Current	$I_{EBO}$	—	100	nA	$V_{EB} = 4.0V$
Gain Bandwidth Product	$f_T$	100	—	MHz	$V_{CE} = 5.0V, I_C = 10mA, f = 50MHz$
Collector-Base Capacitance	$C_{CBO}$	—	12	pF	$V_{CB} = 10V, f = 1.0MHz$

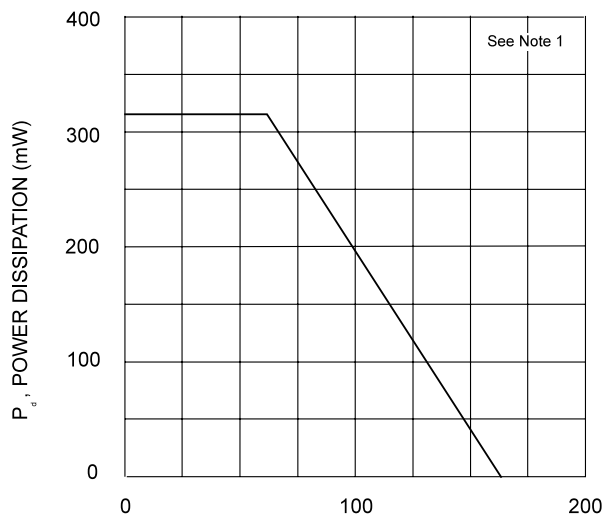

$T_{sB}$ , SUBSTRATE TEMPERATURE (°C)

Fig. 1, Power Derating Curve

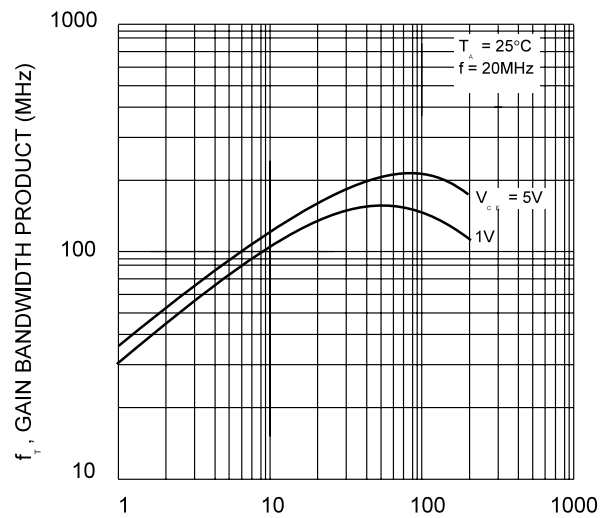

$I_C$ , COLLECTOR CURRENT (mA)

Fig. 2, Gain-Bandwidth Product vs Collector Current

# BC817-16 thru BC817-40

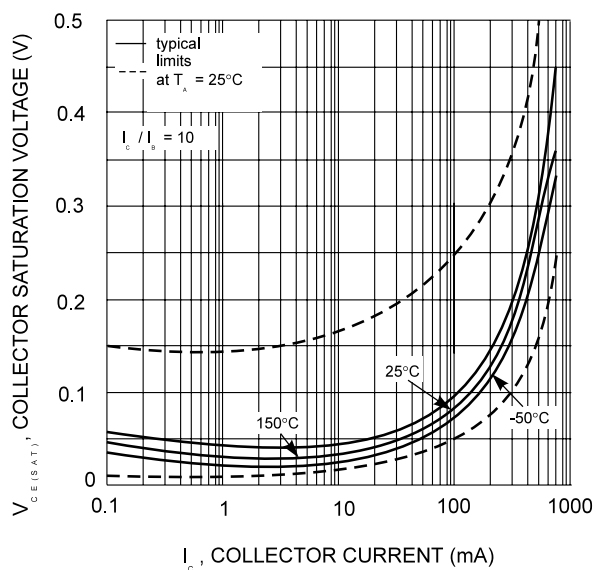

Fig. 3, Collector Sat. Voltage vs Collector Current

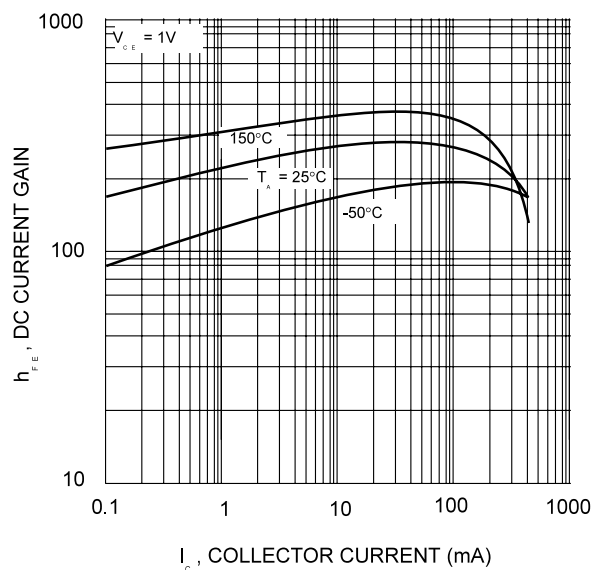

Fig. 4, DC Current Gain vs Collector Current

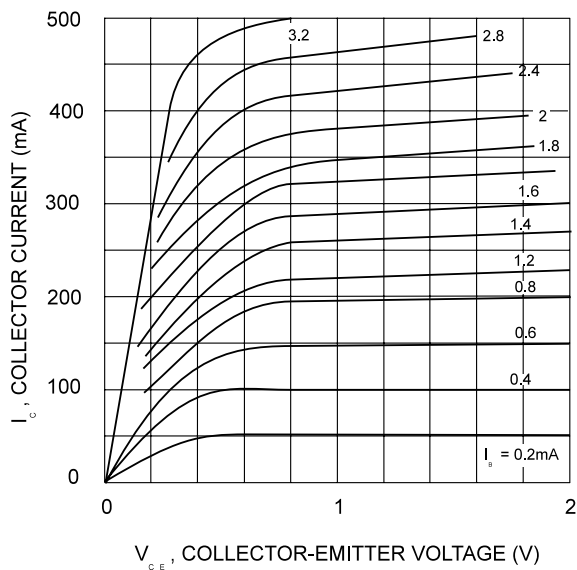

Fig. 5, Typical Emitter-Collector Characteristics

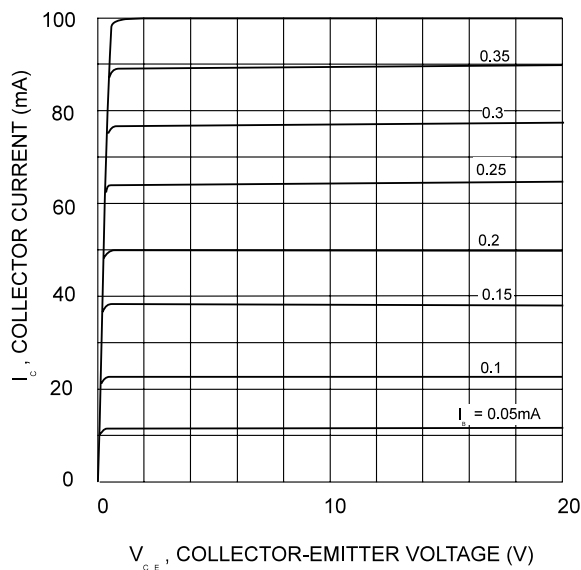

Fig. 6, Typical Emitter-Collector Characteristics