



The Future of Analog IC Technology®

# EV6001DN-00D

WLED Driver  
Evaluation Board

## GENERAL DESCRIPTION

The EV6001DN-00D is an evaluation board for the WLED driver application. It can drive 6 20mA strings of WLEDs with up to 10 WLEDs per string. EV6001DN-00D has good current balance among 6 strings. It also has PWM dimming, EN function, and open circuit voltage protection.

This device is available in an 8-pin SOIC package with an exposed pad.

## ELECTRICAL SPECIFICATIONS

Parameter	Symbol	Value	Units
Input Voltage	$V_{IN}$	7 – 21	V
Output Voltage	$V_{OUT}$	33	V
Output Current	$I_{OUT}$	20mA x 6	mA

## FEATURES

- Integrated 150V Power Switch
- Integrated 100V Startup Circuit
- Cycle-by-Cycle Current Limiting
- PWM Dimming
- Open Circuit Protection
- Backlight Current Balance

## APPLICATIONS

- LCD Panel Backlight
- General and Accent Lighting

"MPS" and "The Future of Analog IC Technology" are Registered Trademarks of Monolithic Power Systems, Inc.

## EV6001DN-00D EVALUATION AND LED BOARDS



(L x W x H) 2.6" x 0.6" x 0.2"  
(6.5cm x 1.5cm x 0.5cm)

Board Number	MPS IC Number
EV6001DN-00D	MP6001DN



(L x W x H) 3.3" x 0.8" x 0.2"  
(8.5cm x 2.0cm x 0.5cm)

Board Number	MPS IC Number
MP6001 LED Board -00C	MP6001DN

Efficiency vs  
Input Voltage

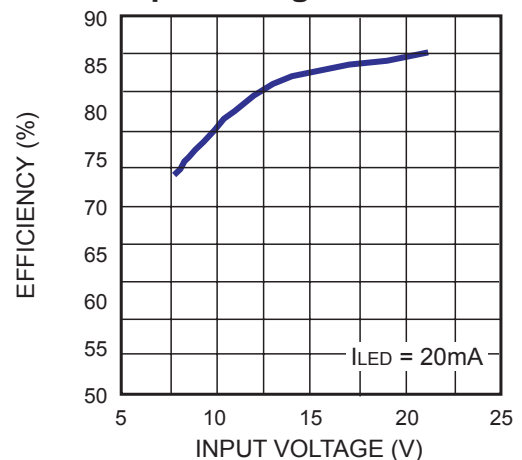

### EVALUATION BOARD SCHEMATIC

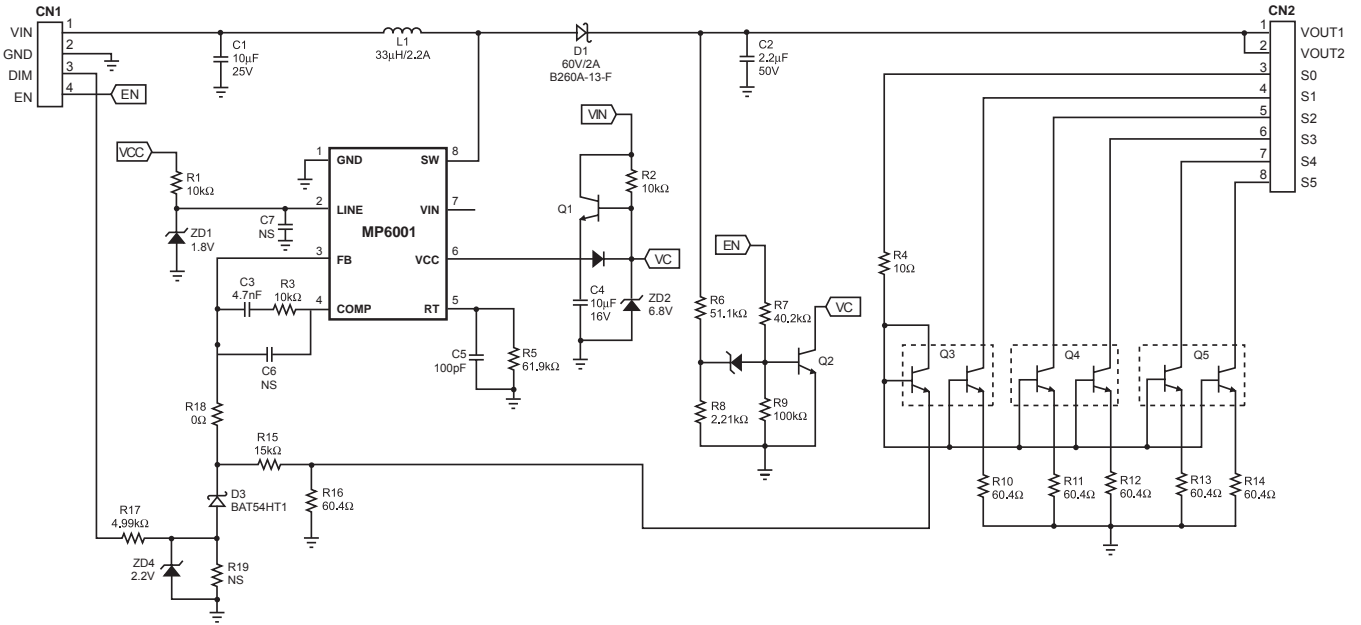

### LED BOARD SCHEMATIC

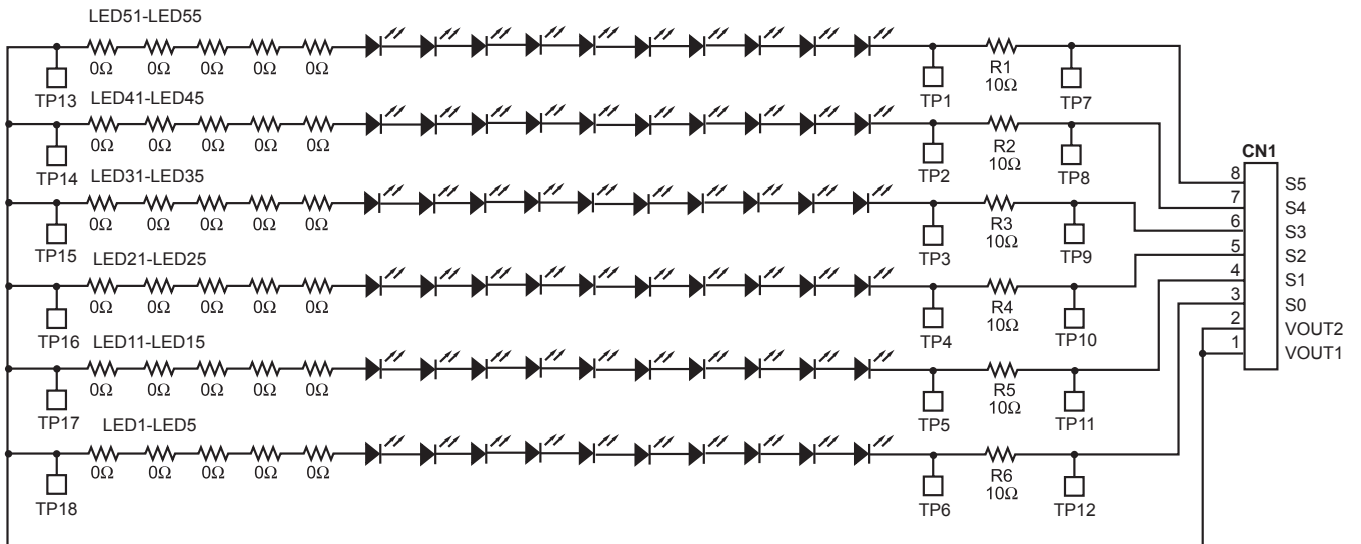

**EV6001DN-00D BILL OF MATERIALS**

Qty	Ref	Value	Description	Package	Manufacturer	Part Number
1	C1	10 $\mu$ F	Ceramic Cap., 25V, X7R	1210	TDK	C3225X7R1E106M
1	C2	2.2 $\mu$ F	Ceramic Cap., 50V, X7R	1210	TDK	C3225X7R1H225K
1	C3	4.7nF	Ceramic Cap., 50V, X7R	603	TDK	C1608X7R1H472K
1	C4	10 $\mu$ F	Ceramic Cap., 16V X7R	1206	TDK	C3216X7R1C106M
1	C5	100pF	Ceramic Cap., 50V, NPO	603	TDK	C1608C0G1H101J
2	C6, C7		Not Stuffed	603		
2	R1, R3	10k $\Omega$	Film Res., 5%	603	Panasonic	ERJ-3GEYJ103V
1	R2	10k $\Omega$	Film Res., 5%	805	Panasonic	ERJ-6GEYJ103V
1	R4	10 $\Omega$	Film Res., 5%	805	Panasonic	ERJ-6GEYJ100V
1	R5	61.9k $\Omega$	Film Res., 1%	603	Panasonic	ERJ-3EKF6192V
1	R6	51.1k $\Omega$	Film Res., 1%	603	Panasonic	ERJ-3EKF5112V
1	R7	40.2k $\Omega$	Film Res., 1%	603	Panasonic	ERJ-3EKF4022V
1	R8	2.21k $\Omega$	Film Res., 1%	603	Panasonic	ERJ-3EKF2211V
1	R9	100k $\Omega$	Film Res., 5%	603	Panasonic	ERJ-3GEYJ104V
6	R10, R11, R12, R13, R14, R16	60.4 $\Omega$	Film Res., 1%	603	Panasonic	ERJ-3EKF60R4V
1	R15	15k $\Omega$	Film Res., 5%	603	Panasonic	ERJ-3GEYJ153V
1	R17	4.99k $\Omega$	Film Res., 1%	603	Panasonic	ERJ-3EKF4991V
1	R18	0 $\Omega$	Film Res., 5%	603	Panasonic	ERJ-3GEY0R00V
1	R19		Not Stuffed	603		
1	L1	33 $\mu$ H	Inductor, 2.2A	SMD	Sumida	CDR7D43MN-330
2	Q1, Q2		Transistor, NPN, 40V, 350mW	SOT-23	Diodes Inc	MMBT3904-7-F
3	Q3, Q4, Q5		Transistor, Dual NPN, 40V, 200mA	SOT-363	Diodes Inc	MMDT3904-7-F
2	ZD1, ZD3		Diode Zener, 1.8V	SOD-323	Central Semiconductor	CMSZ1L8
1	ZD2		Diode Zener, 6.8V	SOD-123	Diodes Inc	BZT52C6V8-7
1	ZD4		Diode Zener, 2.2V	SOD-323	Central Semiconductor	CMDZ2L2
1	CN1		Connector Header, 4P, 2mm		Any	
1	CN2		Connector Header, 8P, 2mm		Any	
1	U1		DC-DC Converter	SO-8	MPS	MP6001DN

**LED BOARD BILL OF MATERIALS** *(continued)*

Qty	Ref	Value	Description	Package	Manufacturer	Part Number
6	R1 – R6	10Ω	Film Res., 5%	805	Panasonic	ERJ-6GEYJ100V
60	LED6 – LED10 LED16 – LED20 LED26 – LED30 LED36 – LED40 LED46 – LED50 LED56 – LED60 LED61 – LED90		White LED, Surface Mount	603	LITE-ON Inc	LTW-C191TS5
30	LED1 – LED5 LED11 – LED15 LED21 – LED25 LED31 – LED35 LED41 – LED45 LED51 – LED55	0Ω	Film Res., 5%	603	Panasonic	ERJ-3GEY0R00V
1	CN1		Connector Header, 8 Pin, 2mm		Any	

**PRINTED CIRCUIT BOARD LAYOUT**

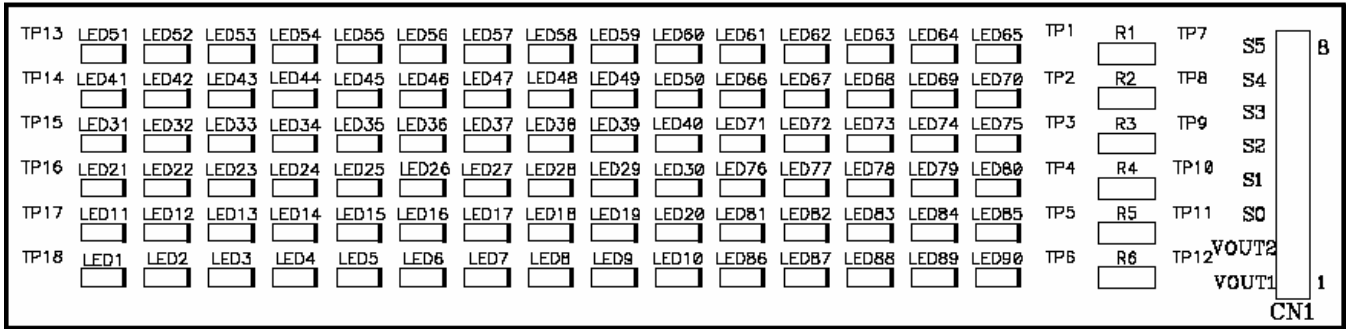

**Figure 1—LED Board Top Silk Layer**



**Figure 2—LED Board Top Layer**



**Figure 3—LED Board Bottom Silk Layer**



**Figure 4—LED Board Bottom Layer**

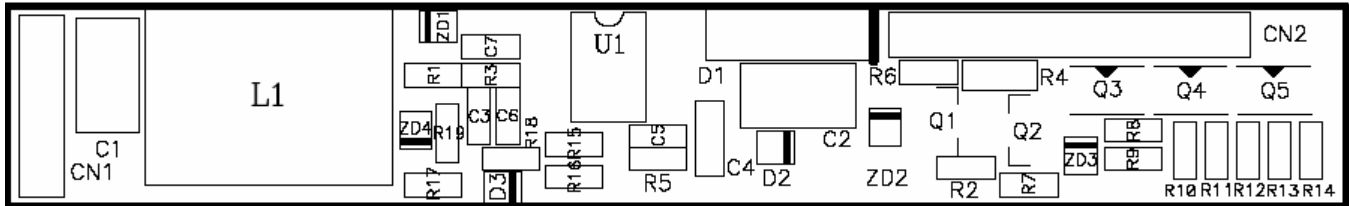

Figure 5—Evaluation Board Top Silk Layer

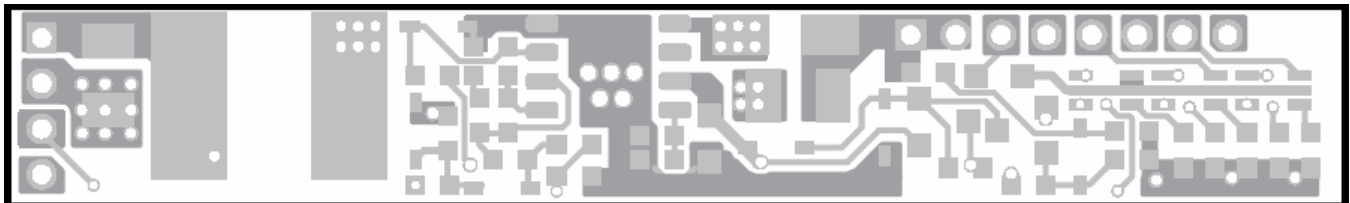

Figure 6—Evaluation Board Top Layer



Figure 7—Evaluation Board Bottom Silk Layer

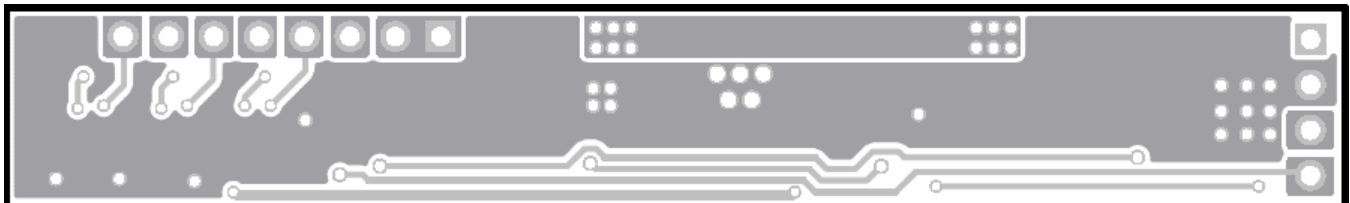

Figure 8—Evaluation Board Bottom Layer

## QUICK START GUIDE

1. Connect the LED board to the WLED driver following the pinout.
2. Preset power supply output to 7V to 21V and turn off the power supply.
3. Connect the positive terminal of the power supply output to VIN pin, and the negative terminal of the power supply output to GND pin.
4. Turn power supply on and the board will automatically startup.
5. To use Enable function, apply a digital input to EN pin. Drive EN with 2.5V-5V to turn off the regulator, and drive EN less than 0.7V to turn it on.
6. To use Dim function, apply a 1KHz PWM signal to DIM pin (High > 4V – 5V, Low < 0.5V). Change the duty cycle to adjust the brightness level.

**NOTICE:** The information in this document is subject to change without notice. Users should warrant and guarantee that third party Intellectual Property rights are not infringed upon when integrating MPS products into any application. MPS will not assume any legal responsibility for any said applications.