

## 200mW High Power Laser Diode

### Description

SLD302WT is a gain-guided, high-power laser diode with a built-in TE cooler. Fine tuning of the wavelength is possible by controlling the laser chip temperature.

### Features

- High power  
Recommended power output  $P_o=180\text{mW}$
- Small operating current
- TO-3 package with built-in TE cooler, thermistor and photodiode

### Structure

GaAlAs double-hetero laser diode

### Applications

- Solid state laser excitation
- Medical use

### Package Outline

Unit: mm

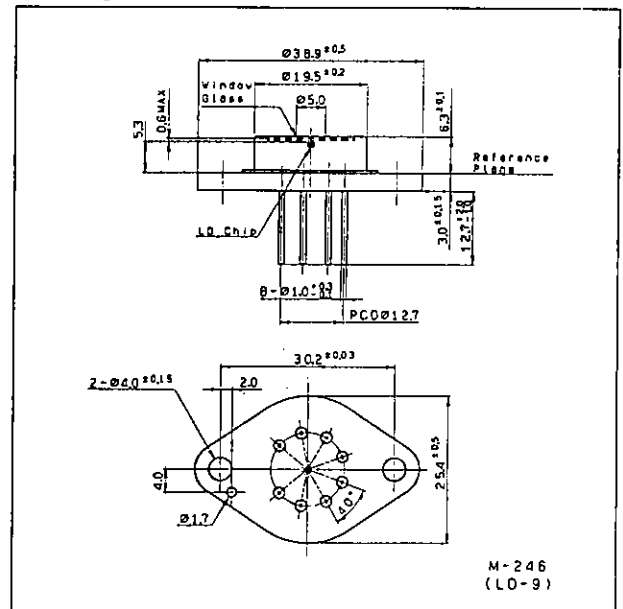

### Absolute Maximum Ratings ( $T_{th}=25^{\circ}\text{C}$ )

• Radiant power output	$P_o$	200	mW
• Reverse voltage	$V_R$	LD 2 PD 15	V
• Operating temperature	$T_{opr}$	-10 to +50	$^{\circ}\text{C}$
• Storage temperature	$T_{stg}$	-40 to +85	$^{\circ}\text{C}$
• Operating current of TE cooler	$I_T$	2.1	A

### Pin Configuration (Bottom View)

No.	Function
1	TE cooler, positive
2	Thermistor lead 1
3	Thermistor lead 2
4	Laser diode cathode
5	Laser diode anode
6	Photodiode anode
7	Photodiode cathode
8	TE cooler, negative

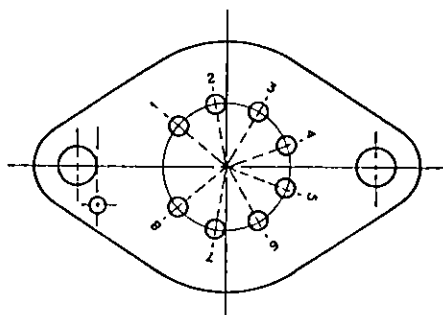

### Equivalent Circuit

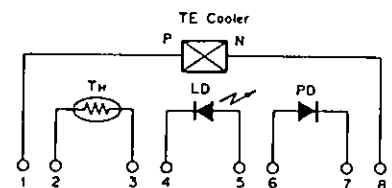

Optical and Electrical Characteristics

T<sub>th</sub>=25°C

Item	Symbol	Condition	Min.	Typ.	Max.	Unit	
Threshold current	I <sub>th</sub>			150	200	mA	
Operating current	I <sub>OP</sub>	P <sub>O</sub> =180mW		350	500	mA	
Operating voltage	V <sub>OP</sub>	P <sub>O</sub> =180mW		1.9	3.0	V	
Wavelength*	λ <sub>p</sub>	P <sub>O</sub> =180mW	770		840	nm	
Monitor current	I <sub>mon</sub>	P <sub>O</sub> =180mW V <sub>R</sub> =10V		0.3		mA	
Radiation angle (F. W. H. M)	Perpendicular	P <sub>O</sub> =180mW			28	40	degree
	Parallel						
Positional accuracy	Position	P <sub>O</sub> =180mW				±100	μm
	Angle						
Slope efficiency	η <sub>D</sub>	P <sub>O</sub> =180mW	0.65	0.9			mW/mA
Thermistor resistance	R <sub>th</sub>	T <sub>th</sub> =25°C		10			kΩ

Note) T<sub>th</sub>: Thermistor temperature

\*Wavelength Selection Classification

Type	Wavelength (nm)
SLD302WT-1	785±15
SLD302WT-2	810±10
SLD302WT-3	830±10
SLD302WT-21	798± 3
-24	807± 3
-25	810± 3

Marking

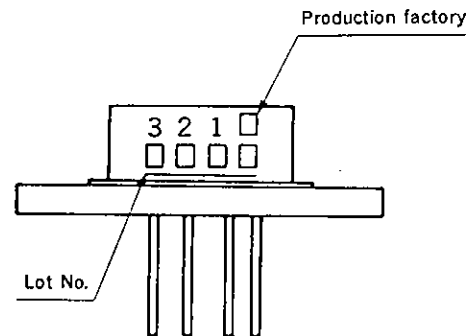

Categories are not specified by marking.

Precautions

Eye protection against laser beams

The optical output of laser diodes ranges from several milliwatts to one watt. However the optical density of the laser beam at the diode chip reaches 1 megawatt per square centimeter. Unlike gas lasers, since laser diode beams are divergent, uncollimated laser diode beams are fairly safe at a laser diode. For observing laser beams, ALWAYS use safety goggles that block infrared rays. Usage of IR scopes, IR cameras and fluorescent plates is also recommended for monitoring laser beams safely.

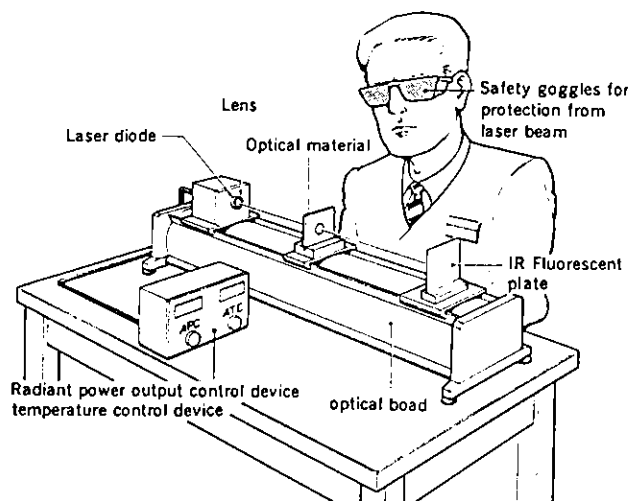

Radiant power output vs. Forward current characteristics

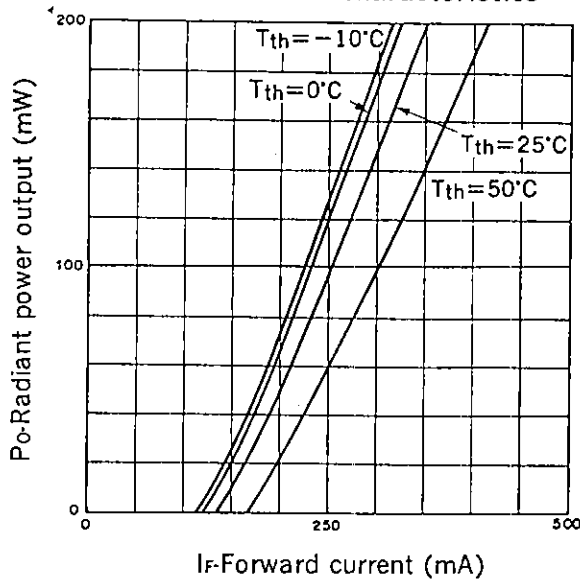

Radiant power output vs. Monitor current characteristics

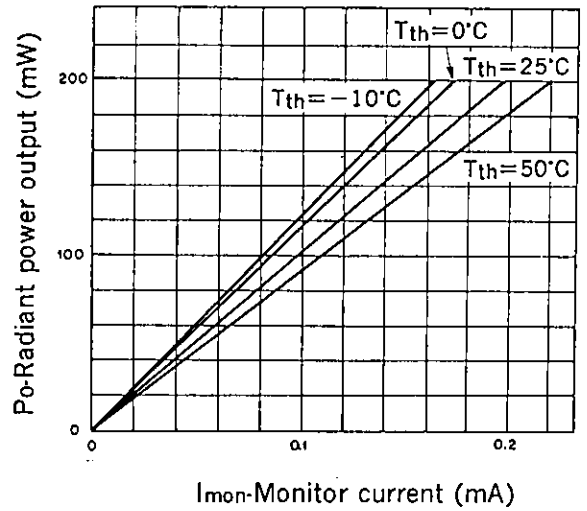

Threshold current vs. Temperature characteristics

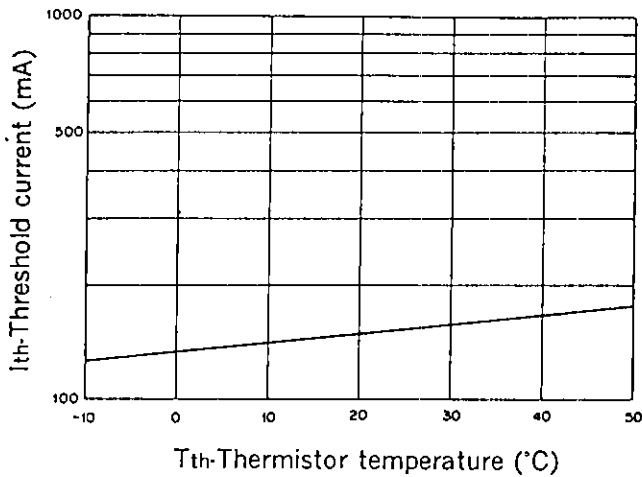

Power dependence of far field pattern (parallel to junction)

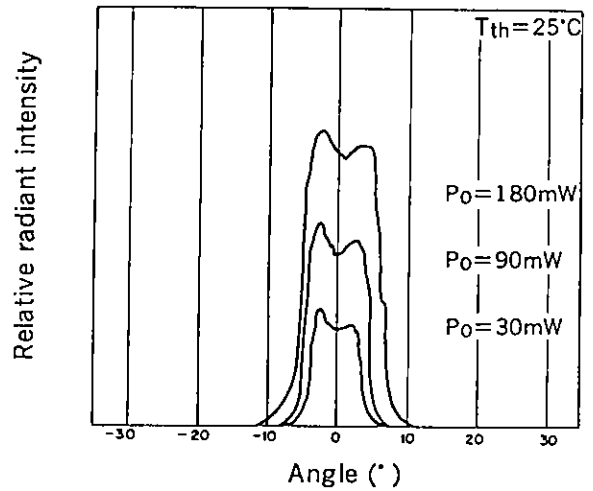

Power dependence of near field pattern

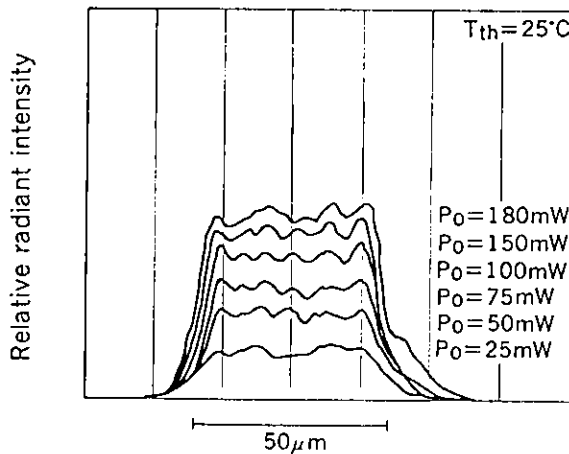

Oscillation wavelength vs. Temperature characteristics

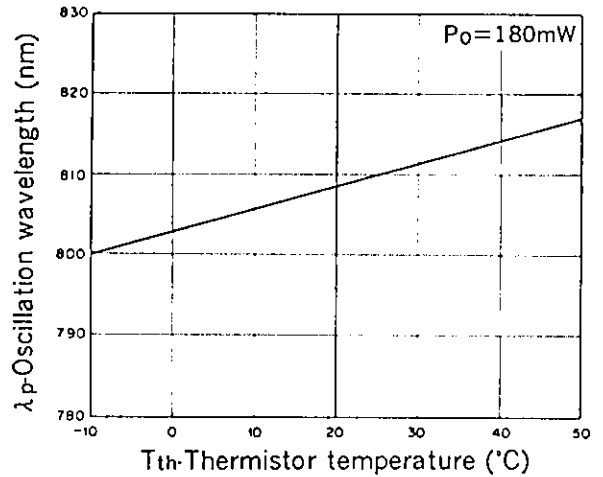

Slope efficiency vs.  
Temperature characteristics

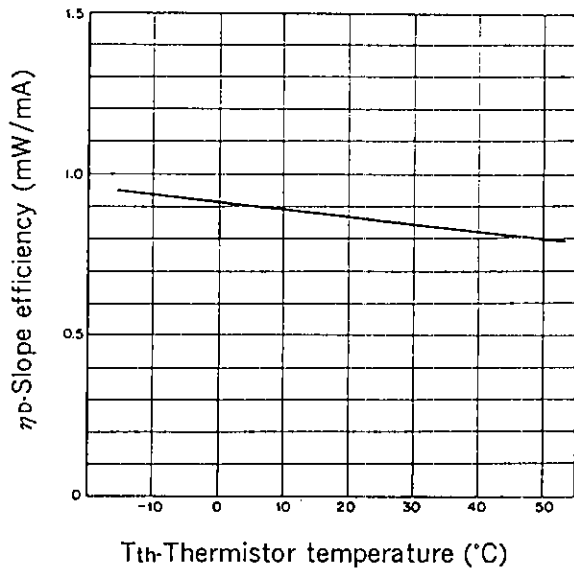

Power dependence of polarization ratio

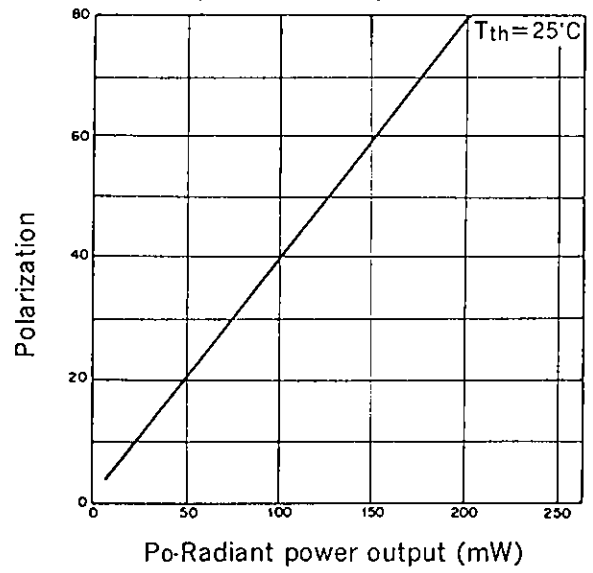

Power dependence of wavelength

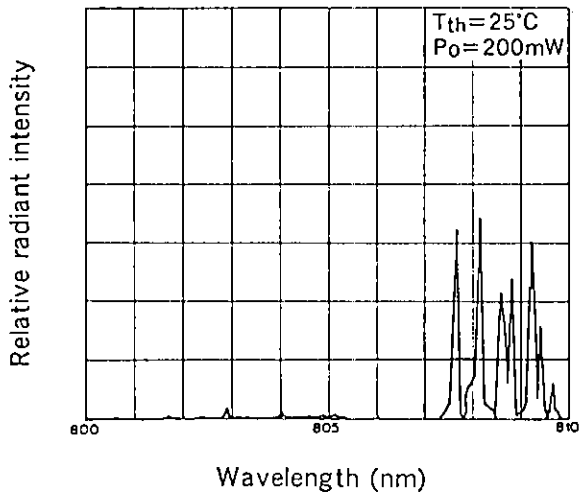
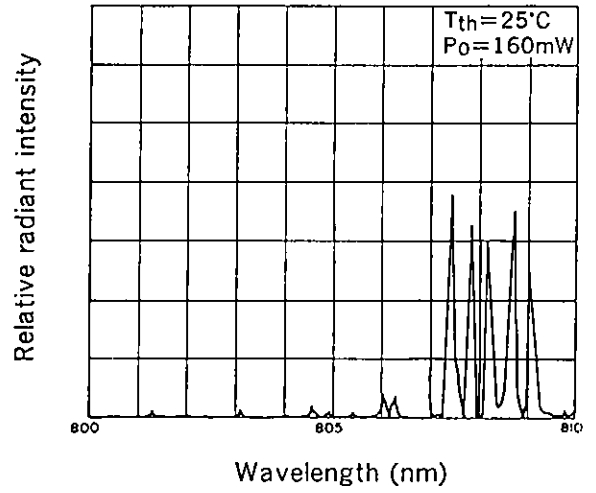
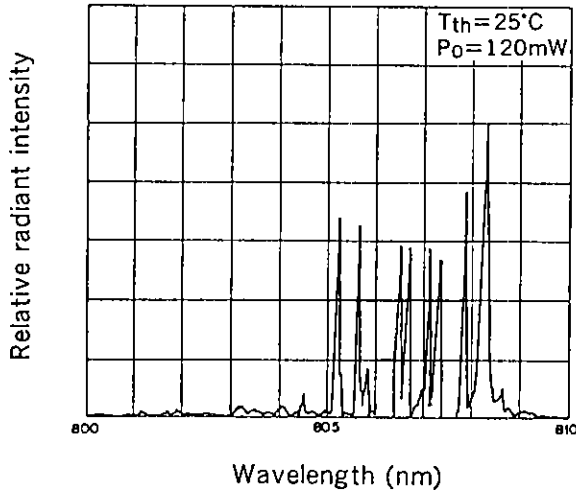
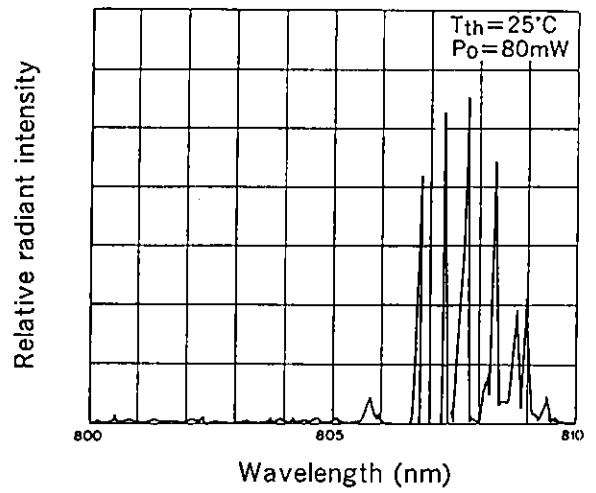
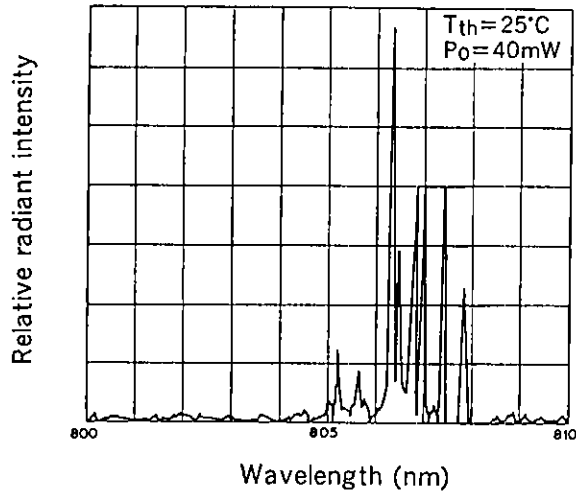

Temperature dependence of wavelength ( $P_o=180mW$ )

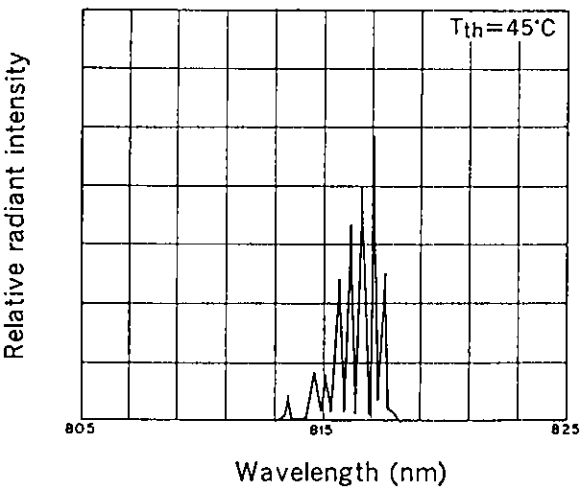
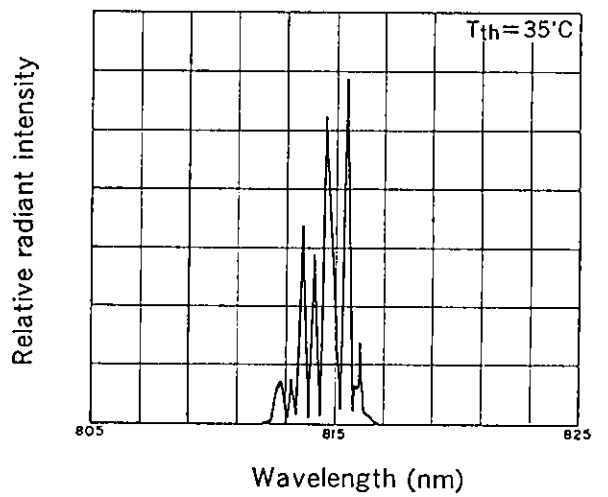
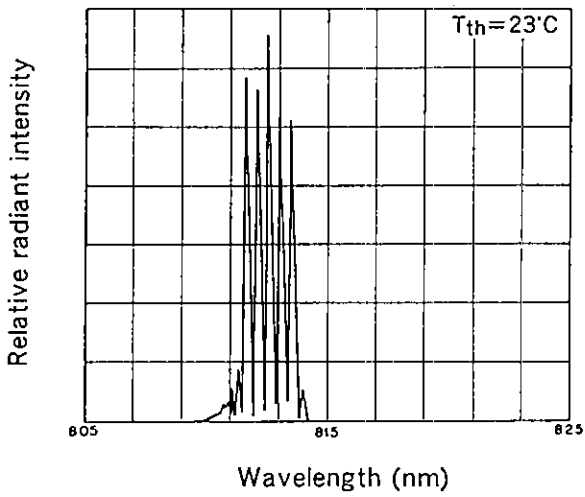
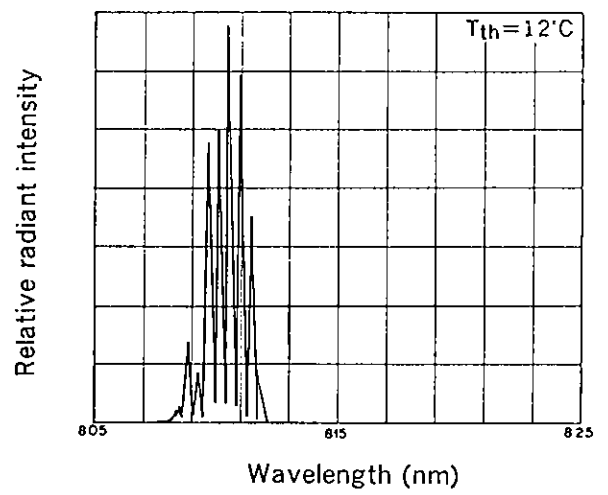
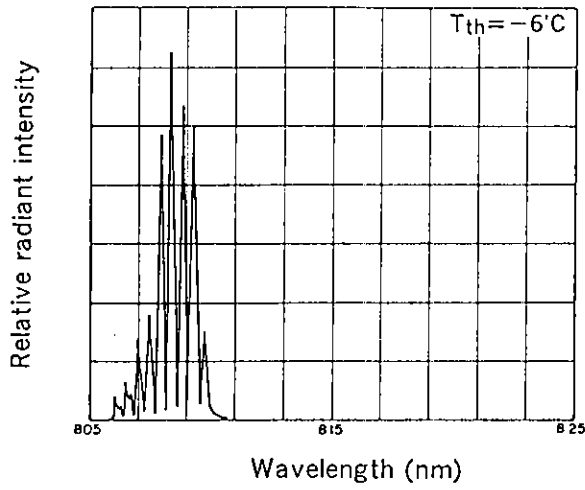

TE cooler characteristics

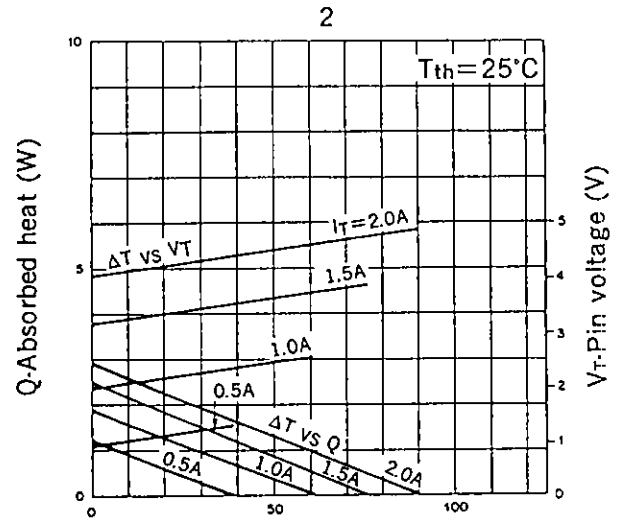
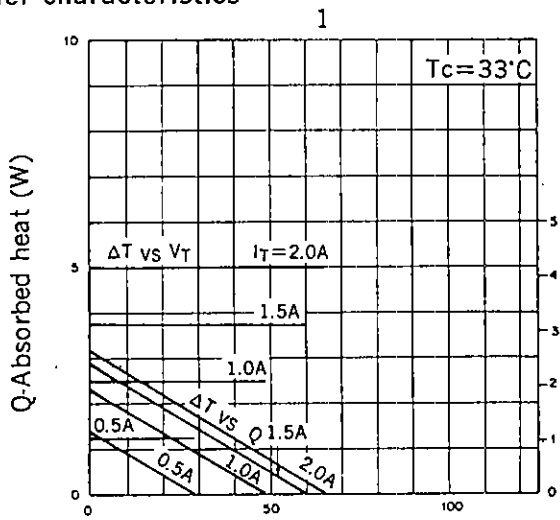

$\Delta T$ -Temperature difference ( $^\circ\text{C}$ )

$\Delta T$ -Temperature difference ( $^\circ\text{C}$ )

$\Delta T$  :  $T_c - T_{th}$   
 $T_{th}$  : Thermistor temperature  
 $T_c$  : Case temperature

Thermistor characteristics

