



Dual N-Channel Enhancement Mode Field Effect Transistor

PRODUCT SUMMARY		
V _{DSS}	I _D	R _{DS(ON)} (mΩ) Max
20V	7A	20 @ V _{GS} = 4.0V 28 @ V _{GS} = 2.5V

FEATURES

- Super high dense cell design for low R_{DS(ON)}.
- Rugged and reliable.
- Surface Mount Package.
- ESD Protected.

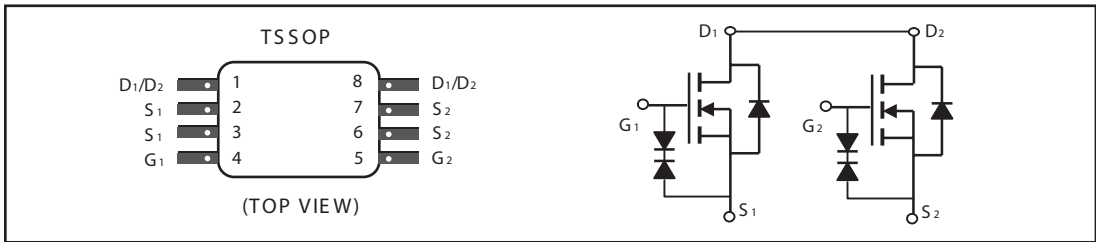

ABSOLUTE MAXIMUM RATINGS (T_A=25°C unless otherwise noted)

Parameter	Symbol	Limit	Unit
Drain-Source Voltage	V _{DS}	20	V
Gate-Source Voltage	V _{GS}	±10	V
Drain Current-Continuous ^a @ T _J =25°C -Pulsed ^b	I _D	7	A
	I _{DM}	28	A
Drain-Source Diode Forward Current ^a	I _S	1.7	A
Maximum Power Dissipation ^a	P _D	1.5	W
Operating Junction and Storage Temperature Range	T _J , T _{STG}	-55 to 150	°C

THERMAL CHARACTERISTICS

Thermal Resistance, Junction-to-Ambient ^a	R _{θJA}	85	°C/W
--	------------------	----	------

STG8210

ELECTRICAL CHARACTERISTICS (T_A = 25 °C unless otherwise noted)

Parameter	Symbol	Condition	Min	Typ ^c	Max	Unit
OFF CHARACTERISTICS						
Drain-Source Breakdown Voltage	BV _{DSS}	V _{GS} = 0V, I _D = 250µA	20			V
Zero Gate Voltage Drain Current	I _{DSS}	V _{DS} = 16V, V _{GS} = 0V			1	µA
Gate-Body Leakage	I _{GSS}	V _{GS} = ±10V, V _{DS} = 0V			±10	µA
ON CHARACTERISTICS ^b						
Gate Threshold Voltage	V _{GS(th)}	V _{DS} = V _{GS} , I _D = 250µA	0.5	0.7	1.5	V
Drain-Source On-State Resistance	R _{DS(ON)}	V _{GS} = 4.0V, I _D = 5A		16.5	20	m ohm
		V _{GS} = 2.5V, I _D = 3A		23	28	m ohm
Forward Transconductance	g _{FS}	V _{DS} = 5V, I _D = 5A		12		S
DYNAMIC CHARACTERISTICS ^c						
Input Capacitance	C _{ISS}	V _{DS} = 8V, V _{GS} = 0V f = 1.0MHz		999		pF
Output Capacitance	C _{OSS}			234		pF
Reverse Transfer Capacitance	C _{RSS}			144		pF
SWITCHING CHARACTERISTICS ^c						
Turn-On Delay Time	t _{D(ON)}	V _{DD} = 10V, I _D = 1A, V _{GEN} = 4.0V, R _L = 10 ohm R _{GEN} = 10 ohm		7.6		ns
Rise Time	t _r			11.2		ns
Turn-Off Delay Time	t _{D(OFF)}			40.2		ns
Fall Time	t _f			19.1		ns
Total Gate Charge	Q _g	V _{DS} = 10V, I _D = 5A, V _{GS} = 4.0V		11.5		nC
Gate-Source Charge	Q _{gs}			2.4		nC
Gate-Drain Charge	Q _{gd}			4		nC

STG8210

ELECTRICAL CHARACTERISTICS ($T_A=25^{\circ}\text{C}$ unless otherwise noted)

Parameter	Symbol	Condition	Min	Typ ^c	Max	Unit
DRAIN-SOURCE DIODE CHARACTERISTICS^b						
Diode Forward Voltage	V_{SD}	$V_{GS} = 0V, I_s = 1.7A$		0.8	1.2	V

Notes

- a. Surface Mounted on FR4 Board, $t \leq 10\text{sec}$.
- b. Pulse Test: Pulse Width $\leq 300\mu\text{s}$, Duty Cycle $\leq 2\%$.
- c. Guaranteed by design, not subject to production testing.

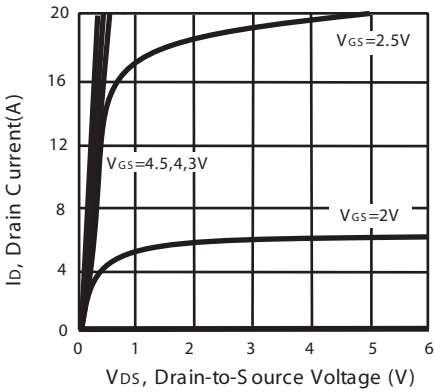

Figure 1. Output Characteristics

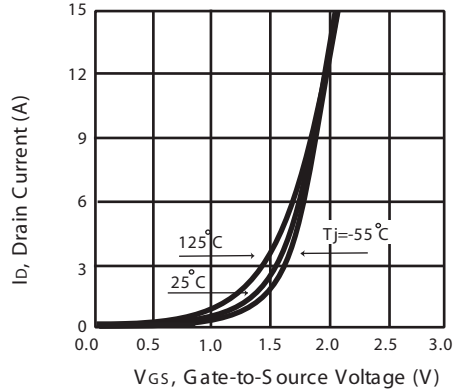

Figure 2. Transfer Characteristics

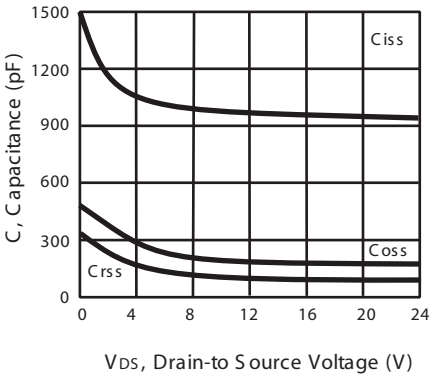

Figure 3. Capacitance

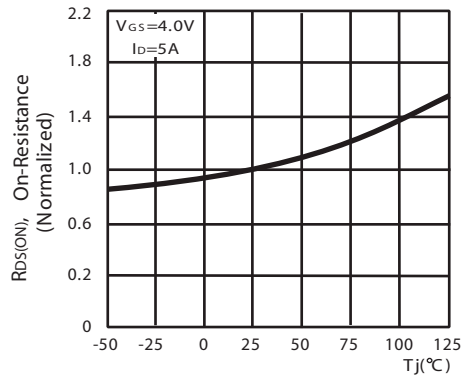
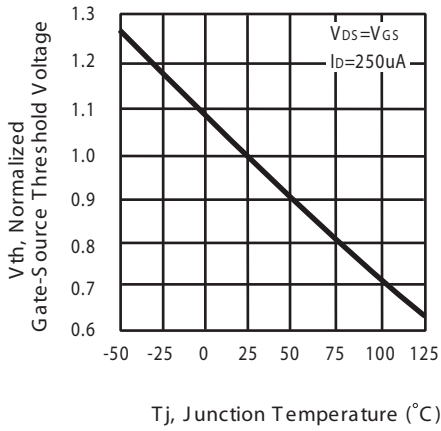

Figure 4. On-Resistance Variation with Temperature

STG8210



with Temperature

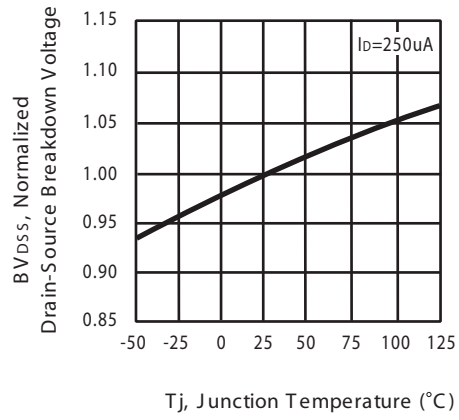

Figure 6. Breakdown Voltage Variation with Temperature

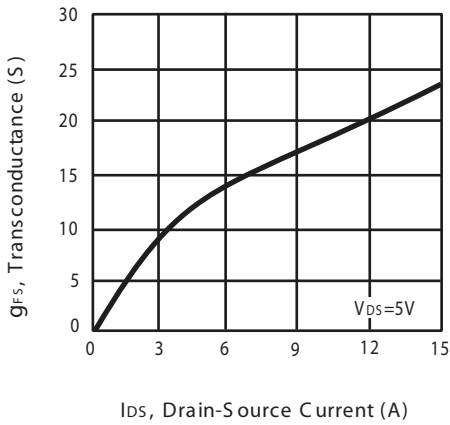

Figure 7. Transconductance Variation with Drain Current

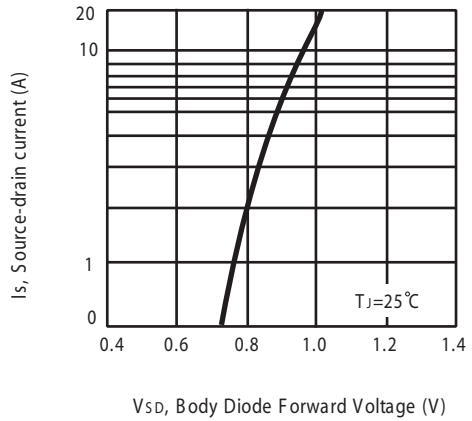

Figure 8. Body Diode Forward Voltage Variation with Source Current

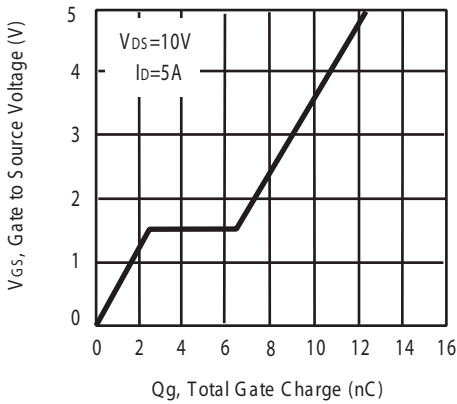

Figure 9. Gate Charge

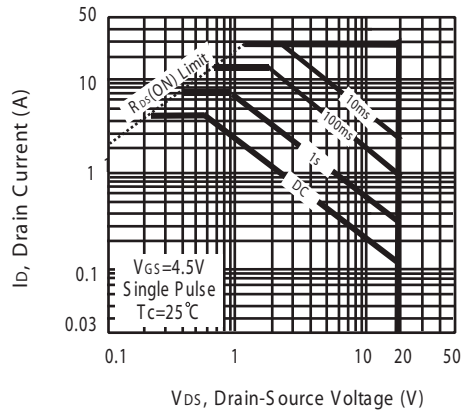

Figure 10. Maximum Safe Operating Area

STG8210

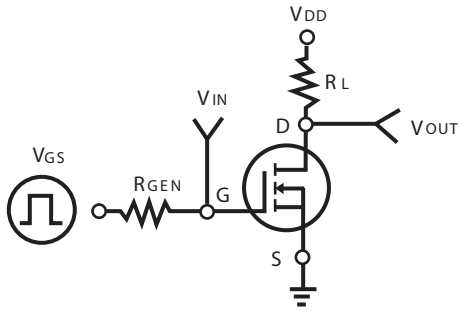

Figure 11. Switching Test Circuit

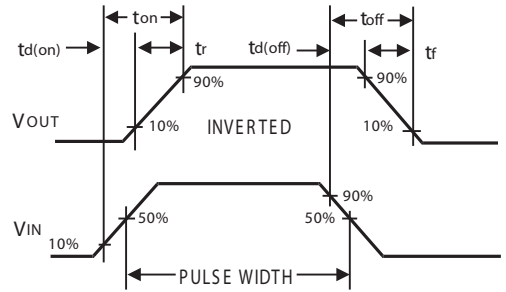

Figure 12. Switching Waveforms

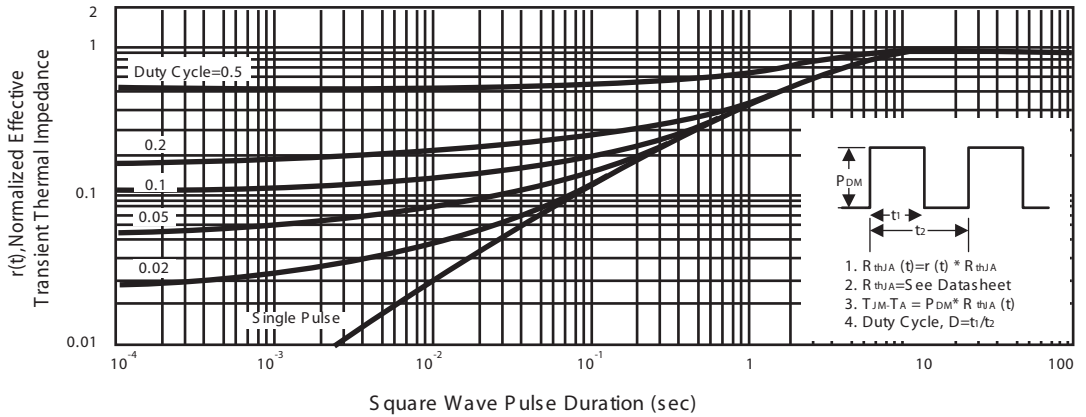
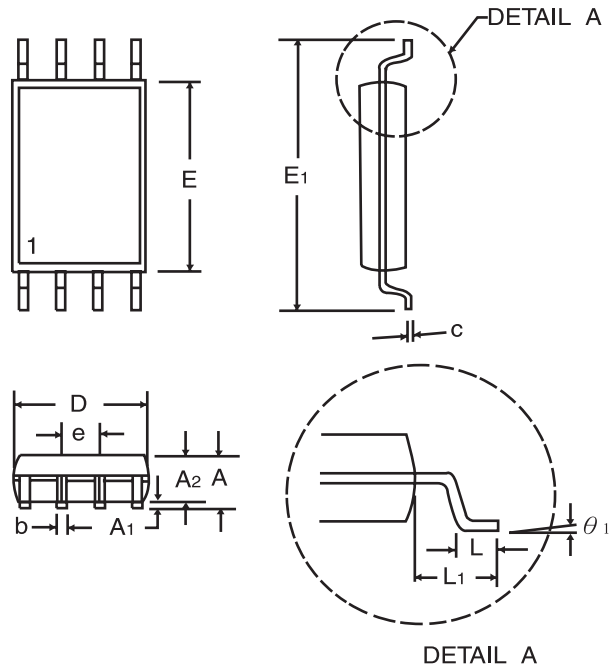

Figure 13. Normalized Thermal Transient Impedance Curve

STG8210

PACKAGE OUTLINE DIMENSIONS

TSSOP-8



SYMBOLS	MILLIMETERS		INCHES	
	MIN	MAX	MIN	MAX
A	1.05	1.20	0.041	0.047
A1	0.05	0.15	0.002	0.006
A2	-	1.05	-	0.041
b	0.20	0.28	0.008	0.011
c	0.127		0.005	
D-8	2.90	3.10	0.114	0.122
E	4.30	4.50	0.169	0.177
E1	6.20	6.60	0.244	0.260
e	0.65BSC		0.025BSC	
L	0.50	0.70	0.020	0.028
L1	1.00		0.039	
θ_1	0°	8°	0°	8°

STG8210

TSSOP-8 Tape and Reel Data

TSSOP-8 Carrier Tape

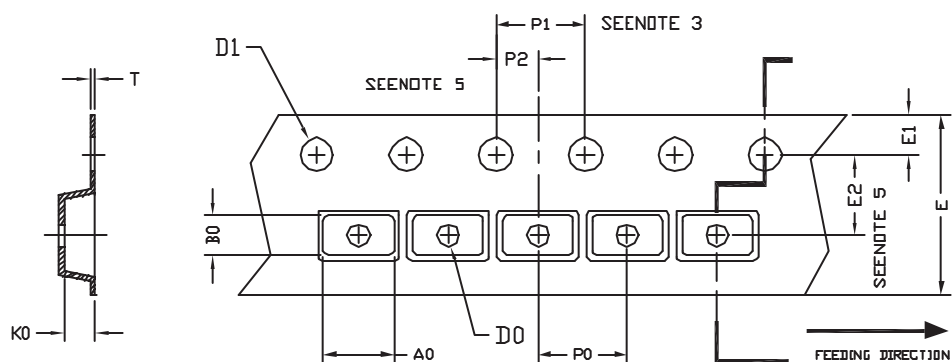

UNIT : mm

PACKAGE	A0	B0	K0	D0	D1	E	E1	E2	P0	P1	P2	T
TSSOP 8	6.08	4.40	1.60	$\phi 1.50$ + 0.1 - 0.0	$\phi 1.50$ + 0.1 - 0.0	12.00 ± 0.3	1.75	5.50 ± 0.05	8.00	4.00	2.00 ± 0.05	0.30 ± 0.05

TSSOP-8 Reel

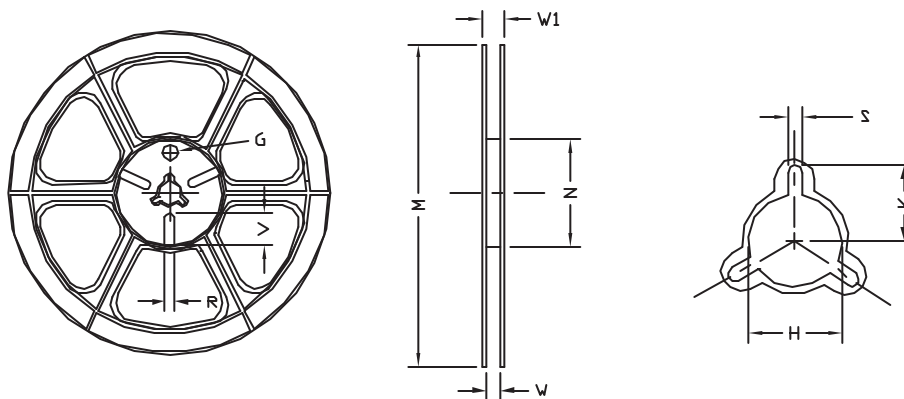

UNIT : mm

TAPE SIZE	REEL SIZE	M	N	W	W1	H	K	S	G	R	V
12 mm	$\phi 330$	330	100	12.5	16.0	$\phi 13.0$ + 0.5 - 0.2	10.6	2.0 ± 0.5	---	---	---