

SHINDENGEN

Darlington Transistor

2SB1283
(TP7J10)

- 7 A PNP

OUTLINE DIMENSIONS

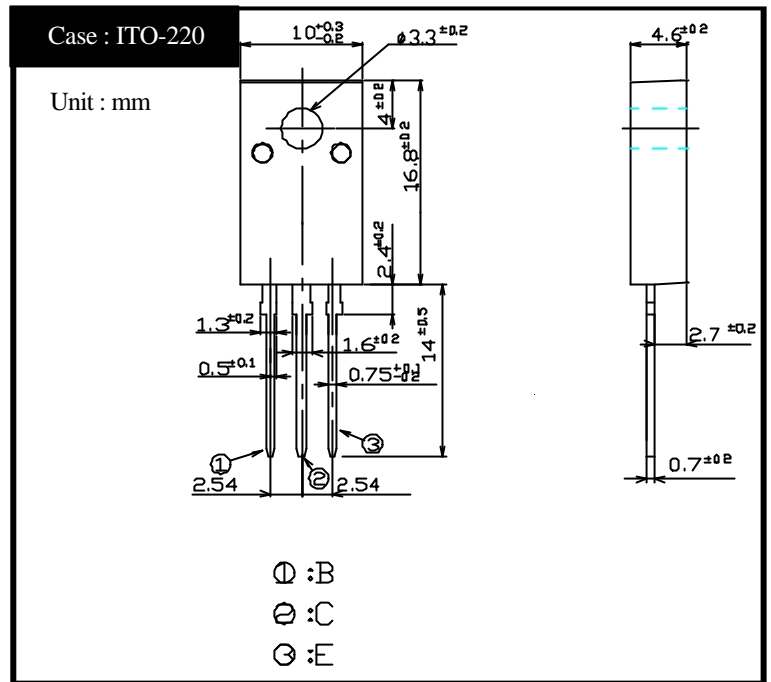

RATINGS

Absolute Maximum Ratings

Item	Symbol	Conditions	Ratings	Unit
Storage Temperature	T_{stg}		-55 ~ +150	
Junction Temperature	T_j		+150	
Collector to Base Voltage	V_{CBO}		-100	V
Collector to Emitter Voltage	V_{CEO}		-100	V
Emitter to Base Voltage	V_{EBO}		-7	V
Collector Current DC	I_C		-7	A
Collector Current Peak	I_{CP}		-10	A
Base Current DC	I_B		-0.5	A
Base Current Peak	I_{BP}		-1	A
Total Transistor Dissipation	P_T	$T_c = 25$	30	W
Dielectric Strength	V_{dis}	Terminals to case AC 1 minute	2	kV
Mounting Torque	TOR	(Recommended torque : 0.3N·m)	0.5	N·m

Electrical Characteristics ($T_c=25$)

Item	Symbol	Conditions	Ratings	Unit
Collector Cutoff Current	I_{CBO}	$V_{CB} = -100V$	Max -0.1	mA
	I_{CEO}	$V_{CE} = -100V$	Max -0.1	
Emitter Cutoff Current	I_{EBO}	$V_{EB} = -7V$	Max -5	mA
DC Current Gain	h_{FE}	$V_{CE} = -3V, I_C = -3A$	Min 1,500	
			Max 15,000	
Collector to Emitter Saturation Voltage	$V_{CE(sat)}$	$I_C = -3A$	Max -1.5	V
Base to Emitter Saturation Voltage	$V_{BE(sat)}$	$I_B = -5mA$	Max -2.0	V
Thermal Resistance	θ_{jc}	Junction to case	Max 4.16	/W
Transition Frequency	f_T	$V_{CE} = 10V, I_C = 0.7A$	TYP 20	MHz
Turn on Time	t_{on}	$I_C = -3A$ $I_{B1} = I_{B2} = -5mA$ $R_L = 10$	Max 1	μs
Storage Time	t_s		Max 4	
Fall Time	t_f		Max 2	

2SB1283 Saturation Voltage

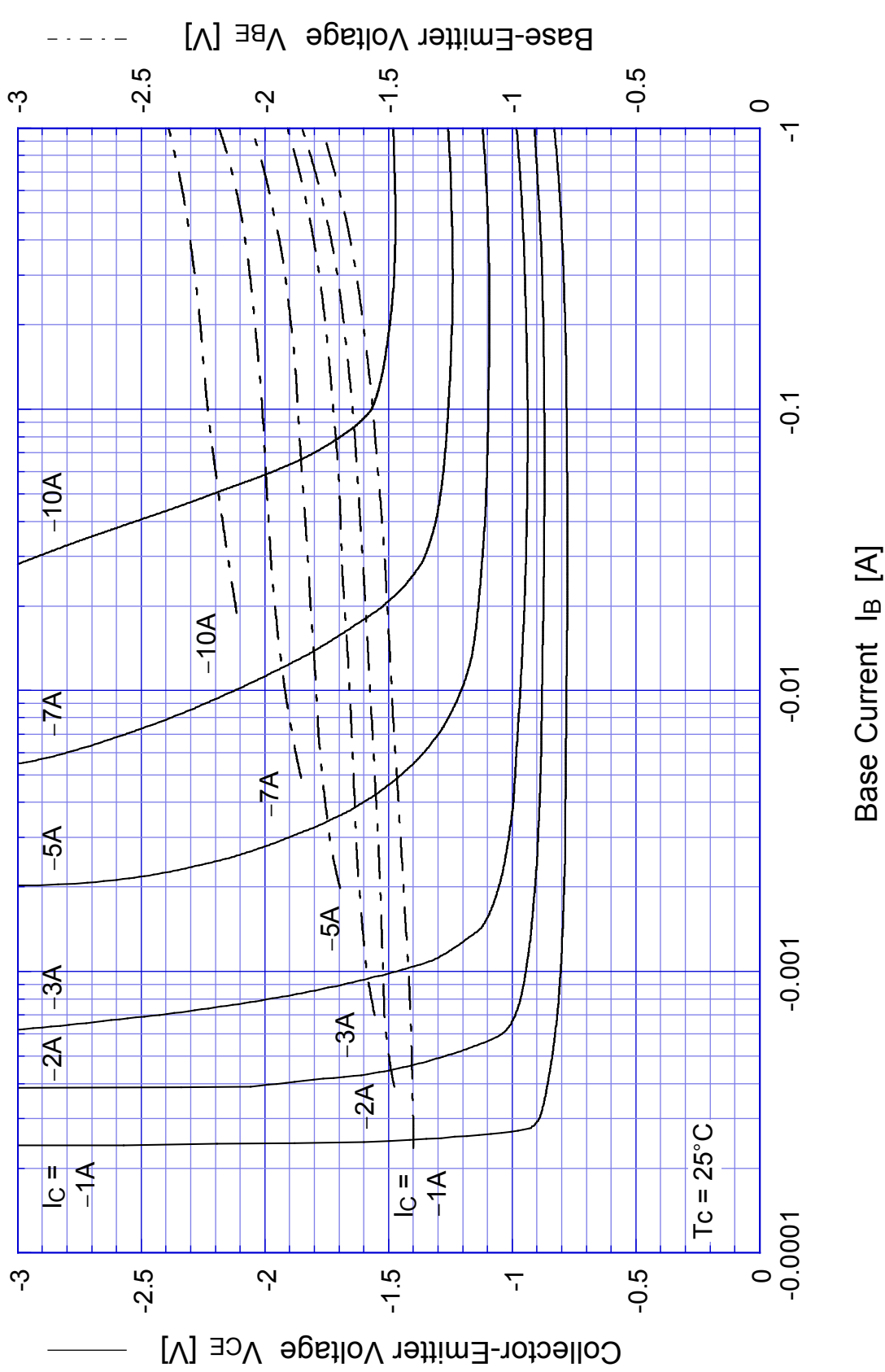

2SB1283

Switching Time - I_C

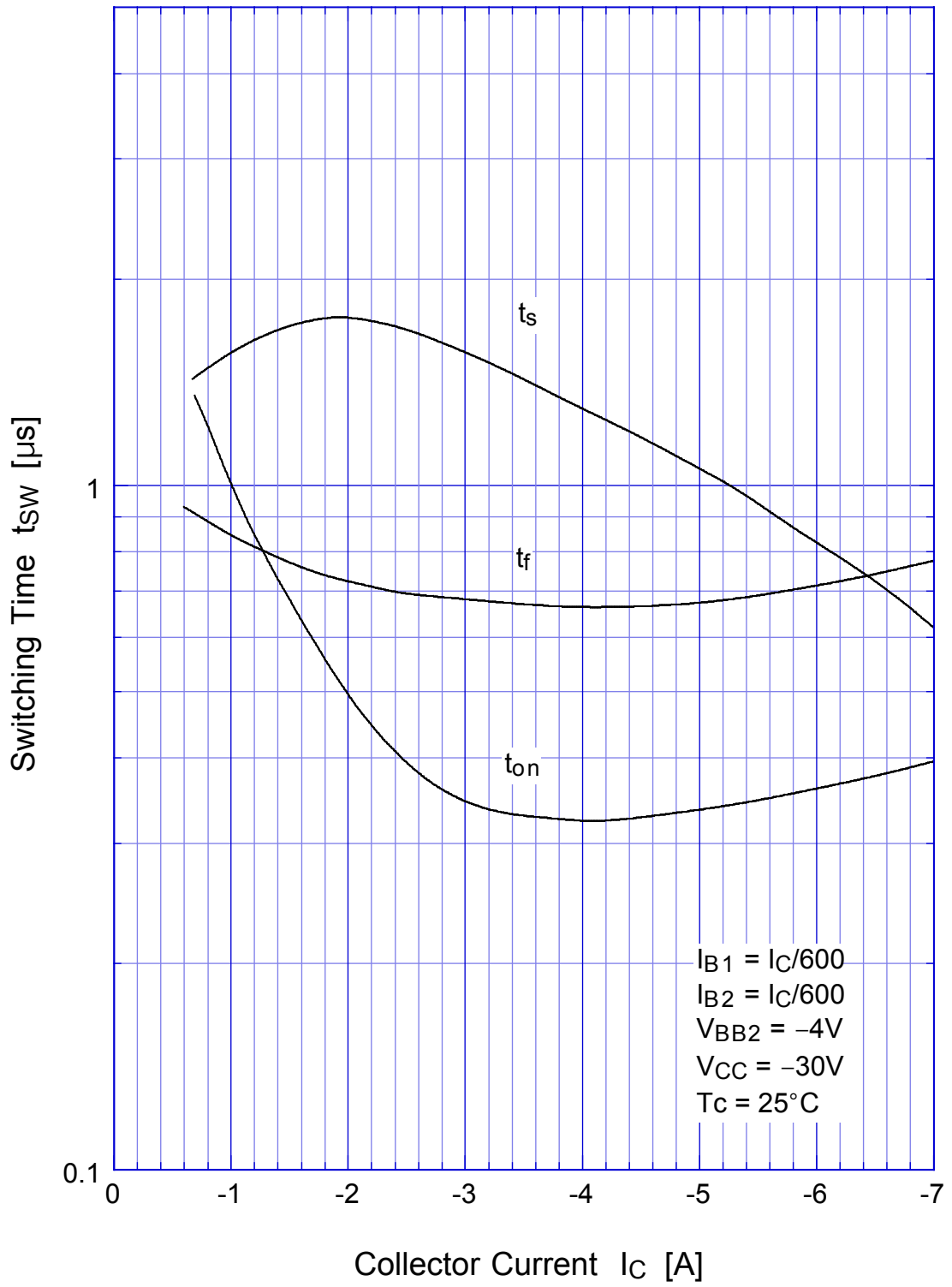

2SB1283

Switching Time - Tc

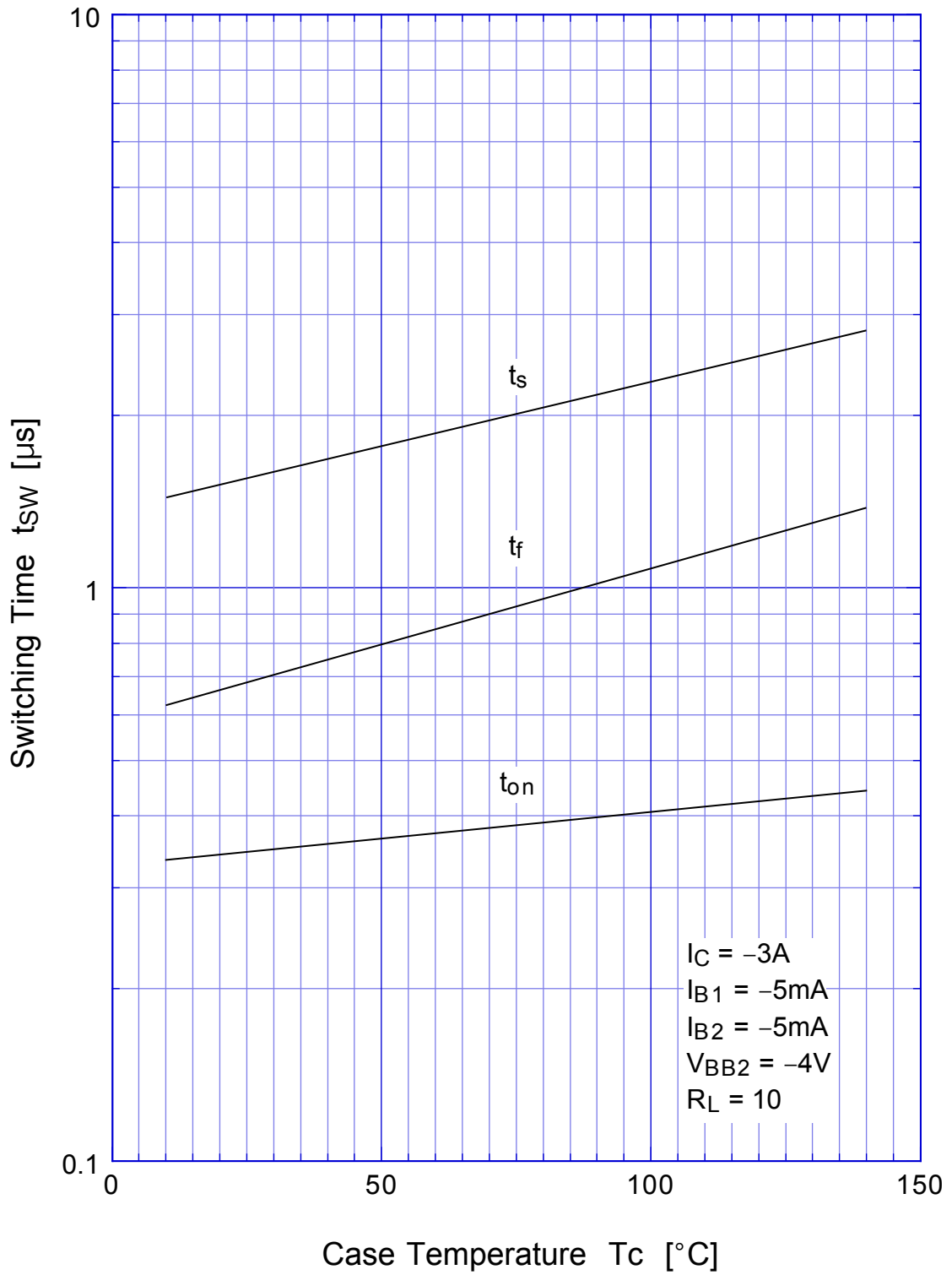

2SB1283 Transient Thermal Impedance

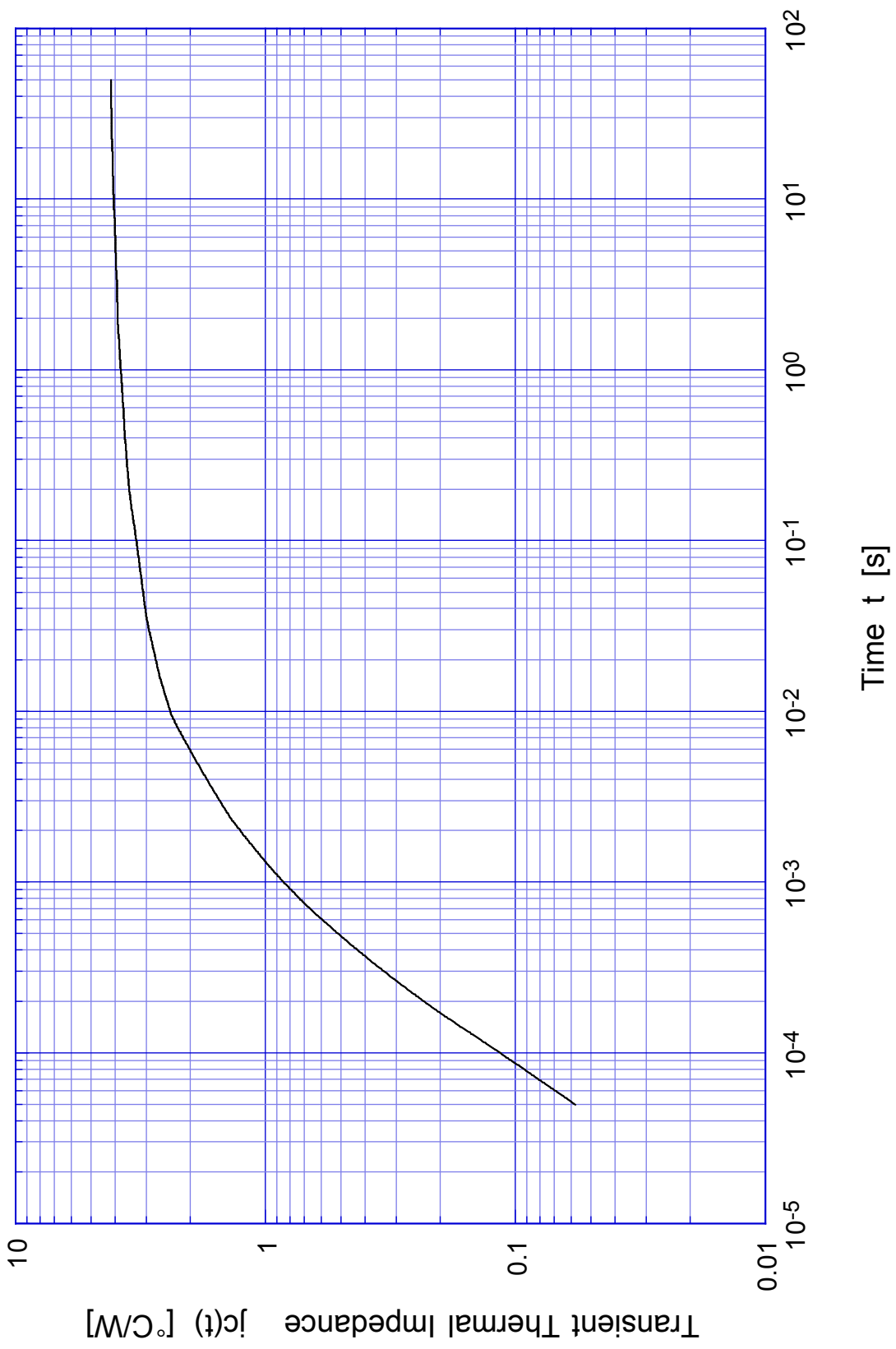

2SB1283

Forward Bias SOA

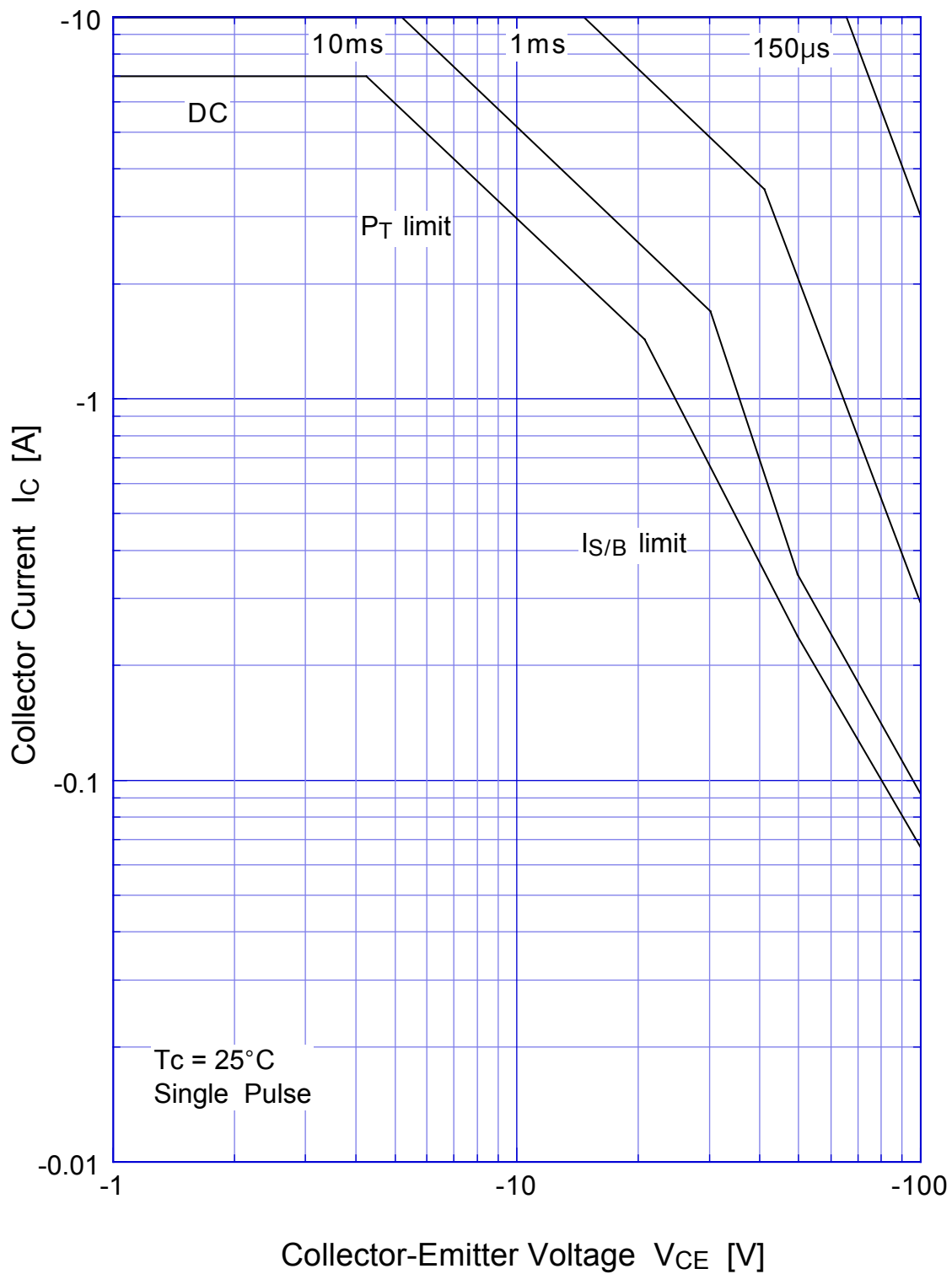

2SB1283 Collector Current Derating

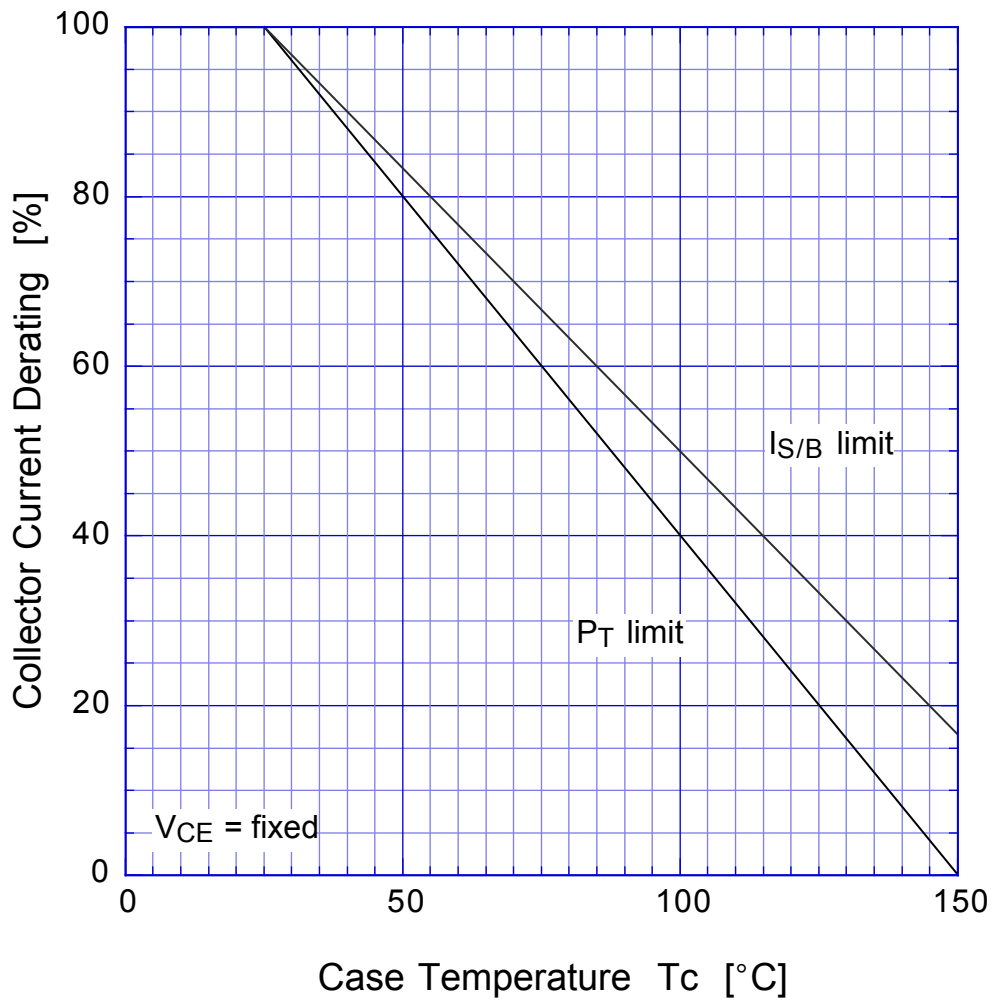

2SB1283

Reverse Bias SOA

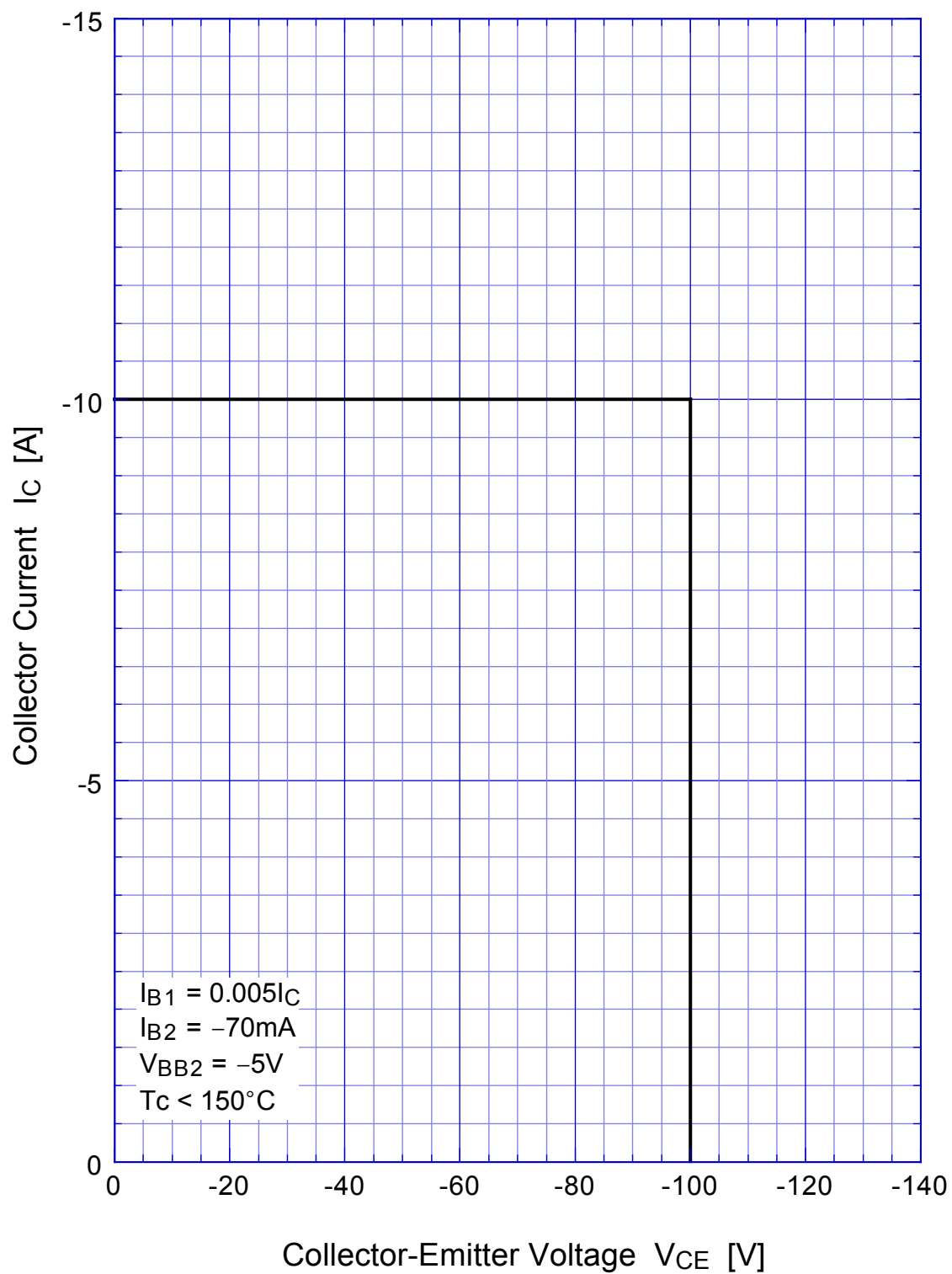

2SB1283

Derating Curve

