

APD3224SURC-F01

HYPER RED

Features

- 3.2x2.4mm SMT LED, 2.4mm THICKNESS.
- LOW POWER CONSUMPTION.
- IDEAL FOR BACKLIGHT AND INDICATOR.
- VARIOUS COLORS AND LENS TYPES AVAILABLE.
- PACKAGE : 1500PCS / REEL.
- RoHS COMPLIANT.

Description

The Hyper Red source color devices are made with DH InGaAlP on GaAs substrate Light Emitting Diode.

Package Dimensions

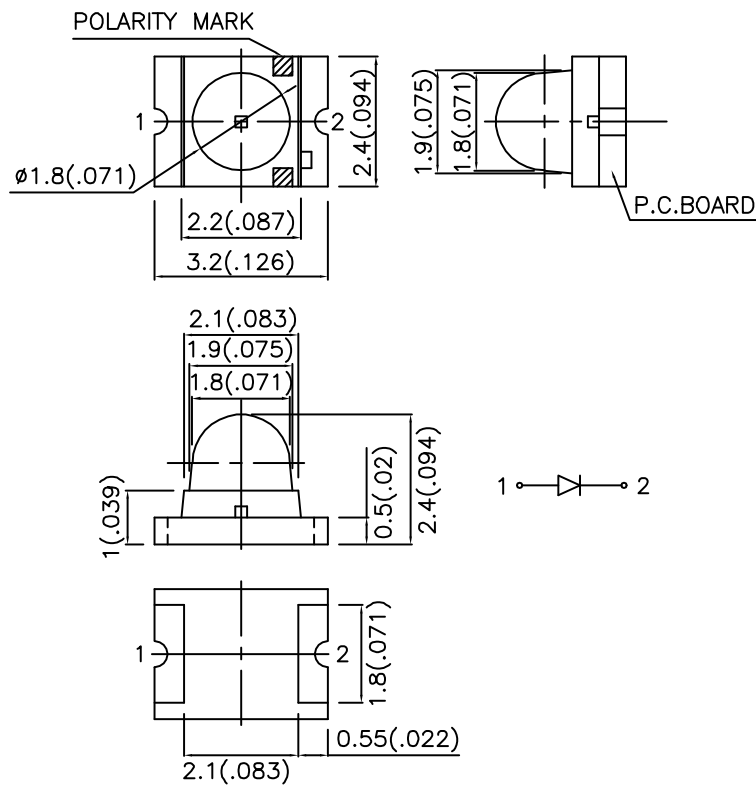

Notes:

1. All dimensions are in millimeters (inches).
2. Tolerance is $\pm 0.1 (0.004)$ unless otherwise noted.
3. Specifications are subject to change without notice.

Selection Guide

Part No.	Dice	Lens Type	Iv (mcd) @ 20mA		Viewing Angle
			Min.	Typ.	2 θ 1/2
APD3224SURC-F01	HYPER RED (InGaAlP)	WATER CLEAR	650	1200	20°

Note:

1. θ 1/2 is the angle from optical centerline where the luminous intensity is 1/2 the optical centerline value.

Electrical / Optical Characteristics at T_A=25°C

Symbol	Parameter	Device	Typ.	Max.	Units	Test Conditions
λ_{peak}	Peak Wavelength	Hyper Red	640		nm	I _F =20mA
λ_D	Dominant Wavelength	Hyper Red	628		nm	I _F =20mA
$\Delta\lambda_{1/2}$	Spectral Line Half-width	Hyper Red	27		nm	I _F =20mA
C	Capacitance	Hyper Red	45		pF	V _F =0V;f=1MHz
V _F	Forward Voltage	Hyper Red	1.9	2.5	V	I _F =20mA
I _R	Reverse Current	Hyper Red		10	uA	V _R = 5V

Absolute Maximum Ratings at T_A=25°C

Parameter	Hyper Red	Units
Power dissipation	170	mW
DC Forward Current	30	mA
Peak Forward Current [1]	185	mA
Reverse Voltage	5	V
Operating/Storage Temperature	-40°C To +85°C	

Note:

1. 1/10 Duty Cycle, 0.1ms Pulse Width.

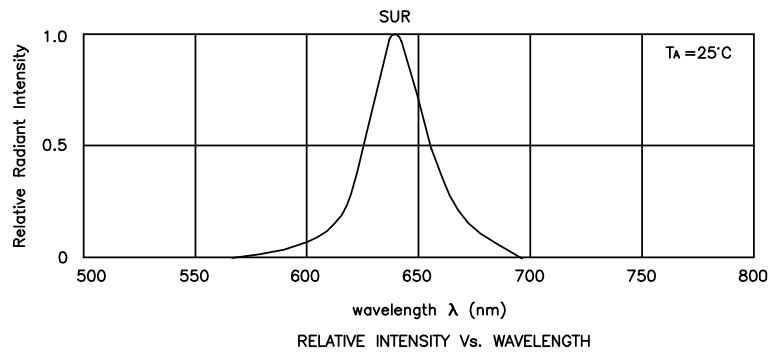

Hyper Red

APD3224SURC-F01

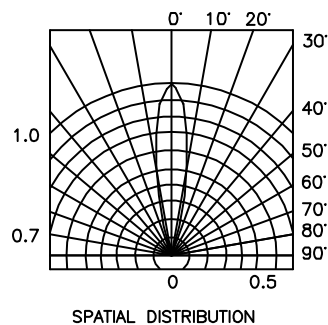
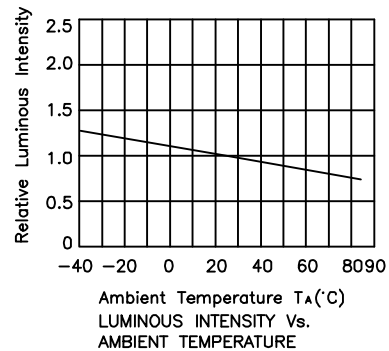
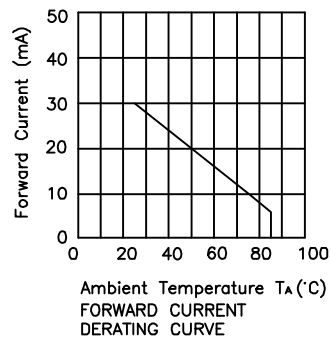
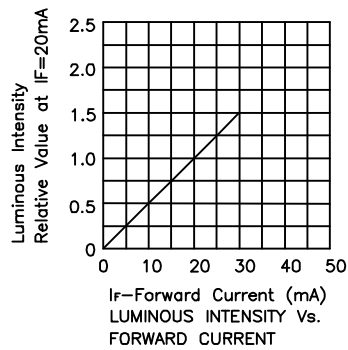
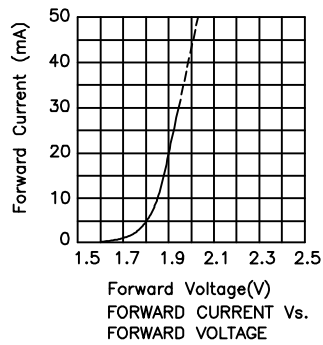

APD3224SURC-F01

Reflow Soldering Profile For Lead-free SMT Process.

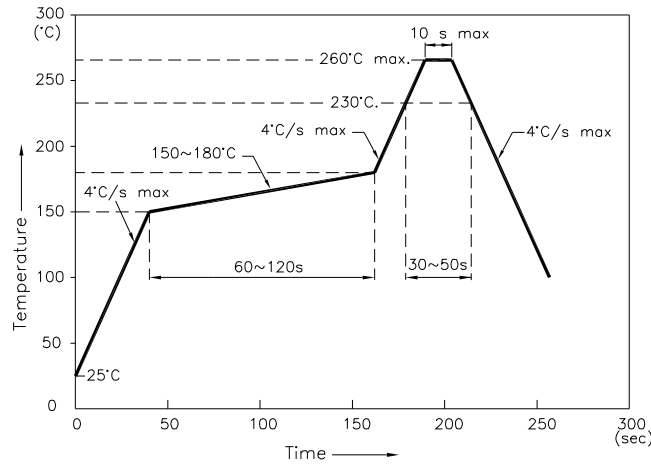

NOTES:

1. We recommend the reflow temperature 245°C(+/-5°C). The maximum soldering temperature should be limited to 260°C.
2. Don't cause stress to the epoxy resin while it is exposed to high temperature.
3. Number of reflow process shall be 2 times or less.

Recommended Soldering Pattern (Units : mm)

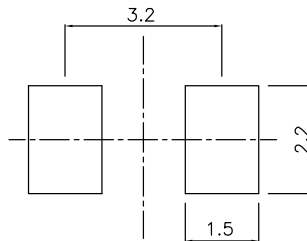

Tape Specifications (Units : mm)

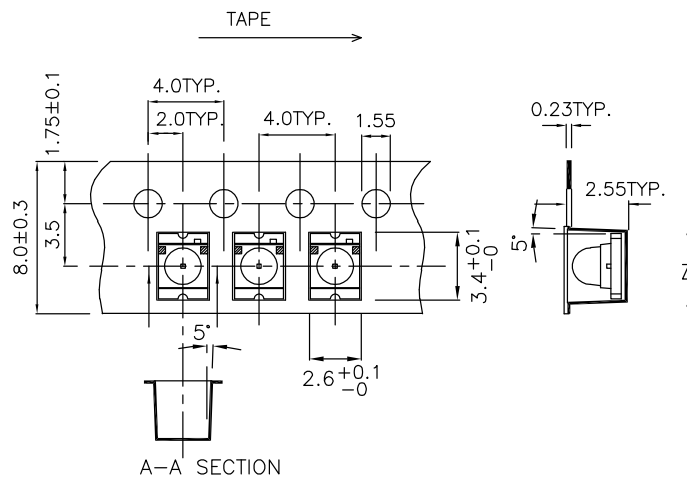

If special sorting is required (e.g. binning based on forward voltage, luminous intensity, or wavelength), the typical accuracy of the sorting process is as follows:

1. Wavelength: +/-1nm
2. Luminous Intensity: +/-15%
3. Forward Voltage: +/-0.1V

Note: Accuracy may depend on the sorting parameters.