

0912-7

7 WATTS - 50 VOLTS
960-1215 MHz

AVIONICS PULSED BIPOLAR

GENERAL DESCRIPTION

The 0912-7 is an internally matched, common base transistor providing 7 watts of pulsed RF output power across the 960-1215 MHz band. This hermetically sealed transistor is specifically designed for avionics pulsed radar applications.

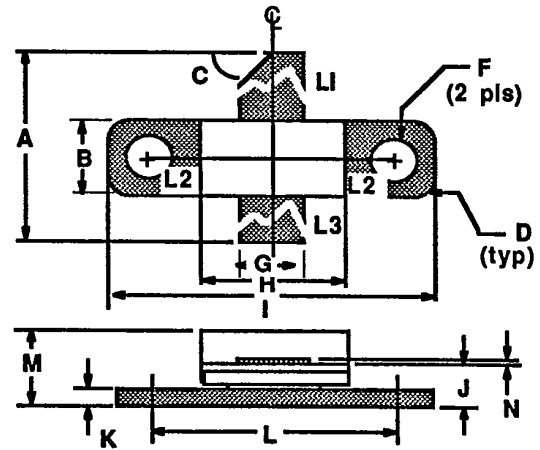

ABSOLUTE MAXIMUM RATINGS

Maximum Power Dissipation @ 25°C Case Temperature **50 W**

Maximum Voltage and Current

BVces Collector to Emitter Voltage **60 V**
 BVebo Emitter to Base Voltage **4.0 V**
 Ic Collector Current **1.0 A**

Maximum Temperatures

Storage Temperature **-65 to +150°C**
 Operating Junction Temperature **+200°C**

DIM	Millimeter	TOL	Inches	TOL
L1 : C				
A	17.78	.76	.70	.03
L2 : B				
B	5.84	.13	.230	.005
L3 : E				
C	45°	5°	45°	5°
D	0.63R	.13	.025R	.005
E	0.13	.02	.005	.001
F	3.30 DIA	.13	.130 DIA	.005
G	5.46	.13	.215	.005
H	9.14	.13	.360	.005
I	20.32	.13	.800	.005
J	3.17	.13	.125	.005
K	1.14	.13	.045	.010
L	14.22	.13	.560	.005
M	5.46	REF	.215	REF

POWER OUTPUT VS POWER INPUT

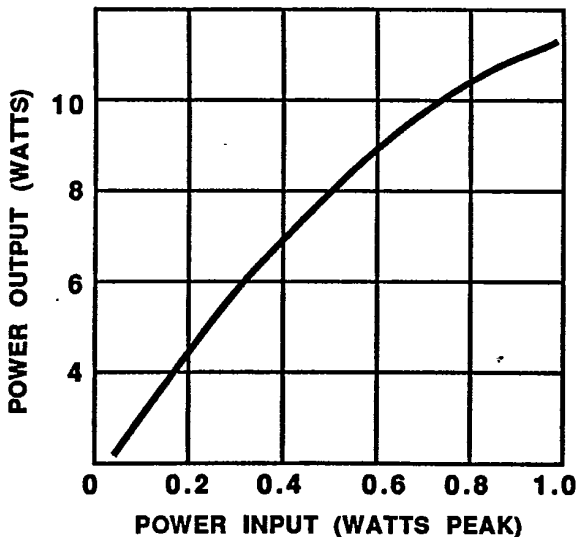

TYPICAL AMPLIFIER LINE UP

Vcc = 50V
 Frequency Range = 960-1215 MHz



490 Race Street, San Jose, CA 95126
 Ewenny Rd., Bridgend, Mid Glamorgan, CF31 3LQ, United Kingdom, Phone (0656) 68021

Phone (408) 294-4200, TWX (910) 338-2172

REV A JULY 1987
 Printed in USA

0912-7-2

ELECTRICAL CHARACTERISTICS¹

SYMBOL	CHARACTERISTICS	TEST CONDITIONS	MIN.	TYP.	MAX.	UNITS
P _{out}	Power Output	f = 960-1215MHz V _{cc} = 50V Pulse Width = 10 μsec Duty = 1%	7			Watts
P _{in}	Power Input				1	Watts
P _g	Power Gain		10			dB
η _c	Collector Efficiency	f = 1090MHz	25			%
VSWR	Load Mismatch Tolerance	At Rated Power Out			10:1	
BV _{ebo}	Breakdown Voltage (Emitter to Base)	I _c = 0A, I _e = 10mA	4			Volts
BV _{ces}	Breakdown Voltage (Collector to Emitter)	V _{be} = 0V, I _c = 20mA	60			Volts
C _{ob}	Capacitance-Collector to Base	V _{cb} = 50V, I _e = 0		6.5	8	pF
h _{fe}	DC-Current Gain	I _c = 100mA, V _{cc} = 5V	10		120	
θ _{jc}	Thermal Resistance				3.5	°C/W

Note 1: T_c = +25°C

POWER OUTPUT VS FREQUENCY (TYPICAL)

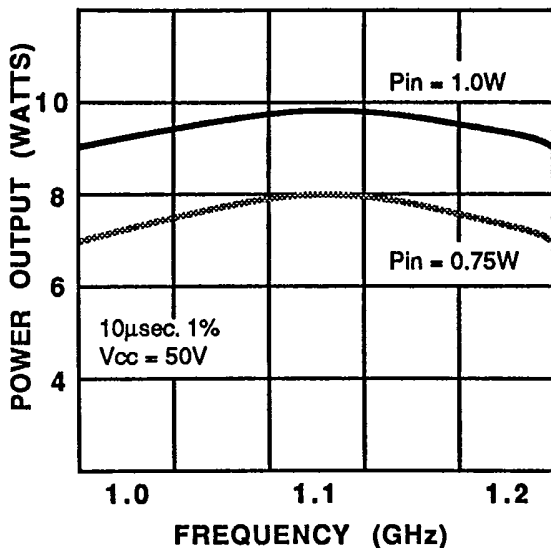

WIDEBAND CIRCUITY INPUT RETURN LOSS (TYPICAL)

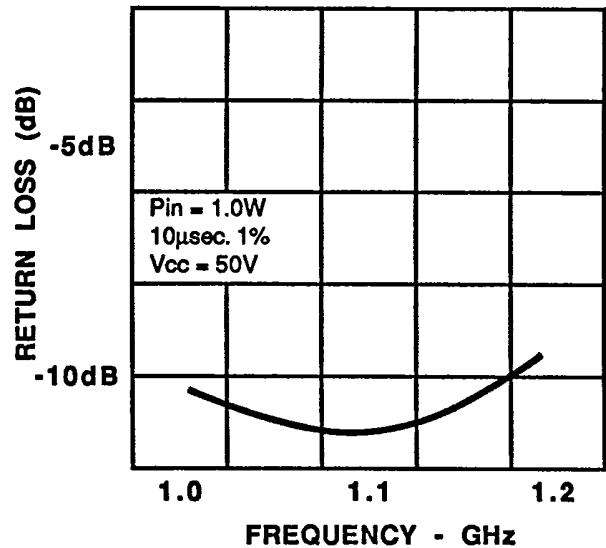

SPECIFICATIONS MAY BE SUBJECT TO CHANGE WITHOUT NOTICE

0912-7-3

SERIES INPUT IMPEDANCE VS FREQUENCY (TYPICAL)

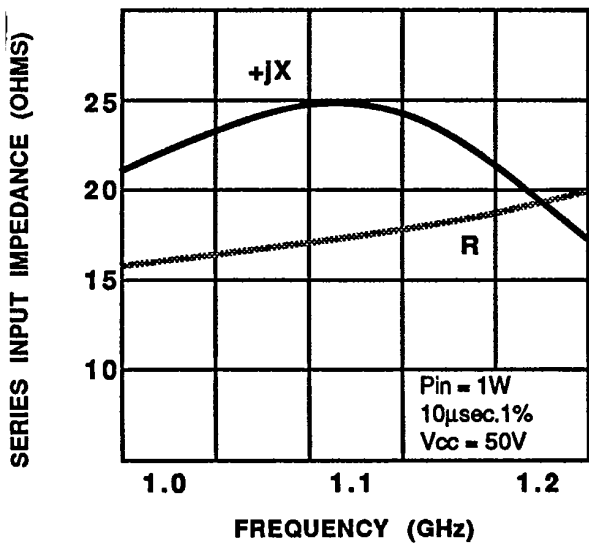

SERIES LOAD IMPEDANCE VS FREQUENCY (TYPICAL)

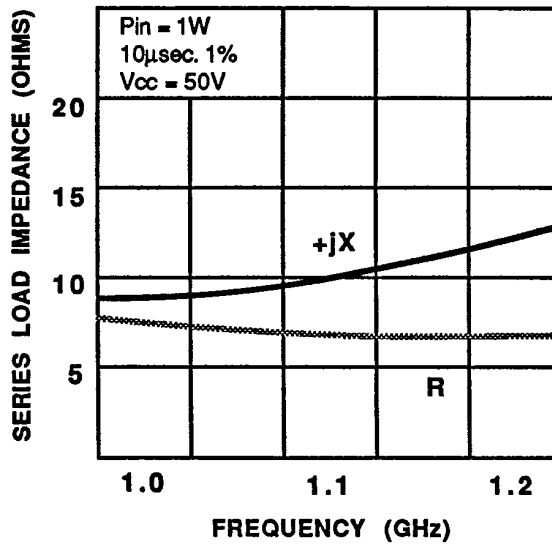

WIDEBAND CIRCUIT COLLECTOR EFFICIENCY VS FREQUENCY (TYPICAL)

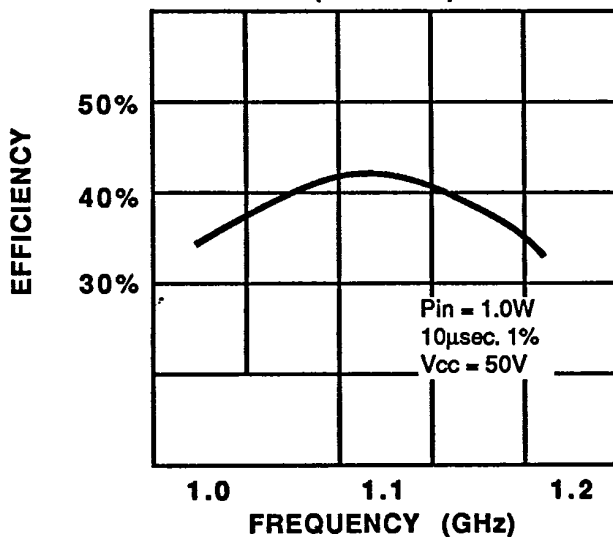

65

0912-7-4

0912-7 CIRCUIT

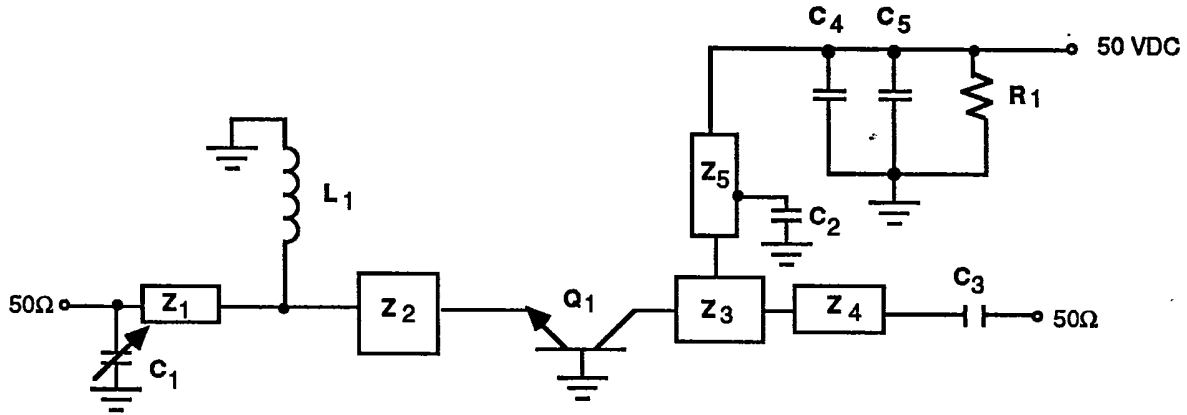

PC Board Material .010" Dielectric Teflon Fiberglass

- Z₁ = 50Ω, .062^l = .027" w x 0.45" L
- Z₂ = 5Ω, .033^l = 0.43" w x 0.23" L
- Z₃ = 10Ω, .06^l = 0.20" w x 0.40" L
- Z₄ = 50Ω = .027" w x any convenient length
- Z₅ = 50Ω, .12^l = .027" w x 0.86" L
- C₁ = Capacitor, .35 - 3.5pF Piston Trimmer
- C₂ = Capacitor, 47pF ATC

- Note: Slide C₂ along Z₅ for best tuning.
- C₃ = Capacitor, 47 pF ATC
- C₄ = Capacitor, 100 pF ATC
- C₅ = Capacitor, 12μfd, 75 VDC, Electrolytic
- L₁ = Inductor, #18 wire, 1.5" long
- R₁ = Resistor, 10KΩ, 1/4 W
- Q₁ = Transistor, Acrian 0912-7

All electrical lengths taken at 1.09 GHz.

66