

# 2SD2467

## Silicon NPN epitaxial planar type

For power switching

### Features

- Low collector to emitter saturation voltage  $V_{CE(sat)}$
- Satisfactory linearity of forward current transfer ratio  $h_{FE}$
- Large collector current  $I_C$
- Full-pack package with outstanding insulation, which can be installed to the heat sink with one screw

### Absolute Maximum Ratings ( $T_C=25^\circ\text{C}$ )

Parameter	Symbol	Rated	Unit
Collector to base voltage	$V_{CBO}$	130	V
Collector to emitter voltage	$V_{CEO}$	80	V
Emitter to base voltage	$V_{EBO}$	7	V
Peak collector current	$I_{CP}$	6	A
Collector current	$I_C$	3	A
Collector power dissipation	$P_C$	30	W
		2	
Junction temperature	$T_j$	150	$^\circ\text{C}$
Storage temperature	$T_{stg}$	-55 to +150	$^\circ\text{C}$

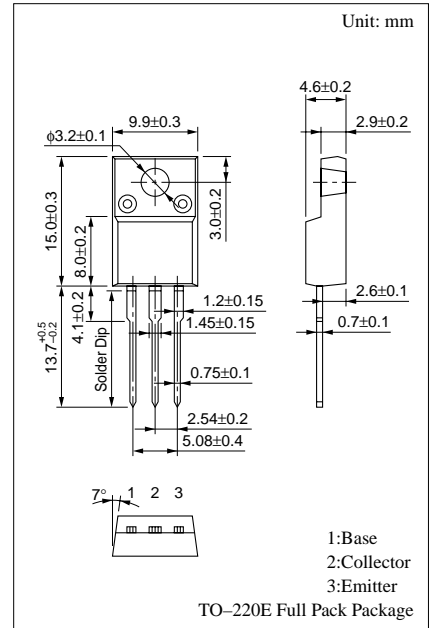

### Electrical Characteristics ( $T_C=25^\circ\text{C}$ )

Parameter	Symbol	Conditions	min	typ	max	Unit
Collector cutoff current	$I_{CBO}$	$V_{CB} = 100\text{V}, I_E = 0$			10	$\mu\text{A}$
Emitter cutoff current	$I_{EBO}$	$V_{EB} = 5\text{V}, I_C = 0$			50	$\mu\text{A}$
Collector to emitter voltage	$V_{CEO}$	$I_C = 10\text{mA}, I_B = 0$	80			V
Forward current transfer ratio	$h_{FE1}$	$V_{CE} = 2\text{V}, I_C = 0.1\text{A}$	45			
	$h_{FE2}^*$	$V_{CE} = 2\text{V}, I_C = 0.5\text{A}$	90		260	
Collector to emitter saturation voltage	$V_{CE(sat)}$	$I_C = 2\text{A}, I_B = 0.1\text{A}$			0.5	V
Base to emitter saturation voltage	$V_{BE(sat)}$	$I_C = 2\text{A}, I_B = 0.1\text{A}$			1.5	V
Transition frequency	$f_T$	$V_{CE} = 10\text{V}, I_C = 0.5\text{A}, f = 10\text{MHz}$		30		MHz
Turn-on time	$t_{on}$	$I_C = 0.5\text{A}, I_{B1} = 50\text{mA}, I_{B2} = -50\text{mA}, V_{CC} = 50\text{V}$		0.5		$\mu\text{s}$
Storage time	$t_{stg}$			2.5		$\mu\text{s}$
Fall time	$t_f$			0.15		$\mu\text{s}$

\* $h_{FE2}$  Rank classification

Rank	Q	P
$h_{FE2}$	90 to 180	130 to 260

$P_C - T_a$

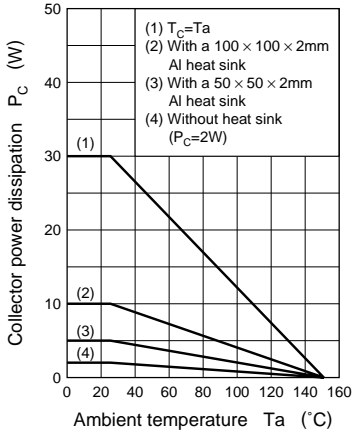

$I_C - V_{CE}$

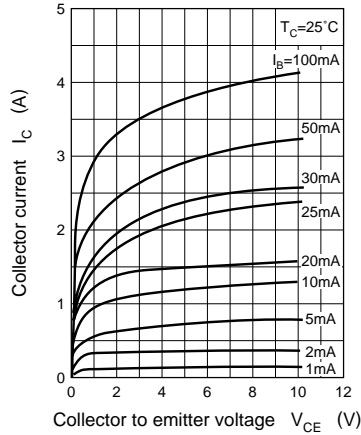

$V_{CE(sat)} - I_C$

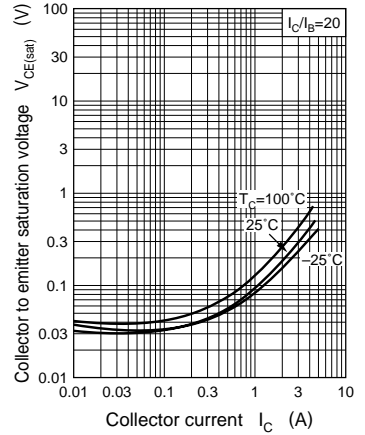

$V_{BE(sat)} - I_C$

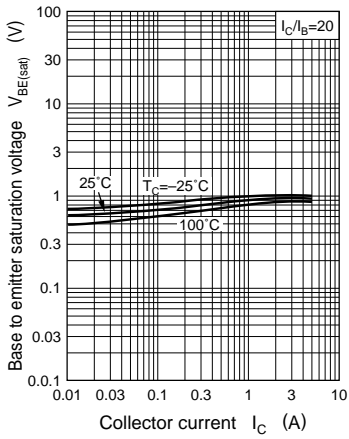

$h_{FE} - I_C$

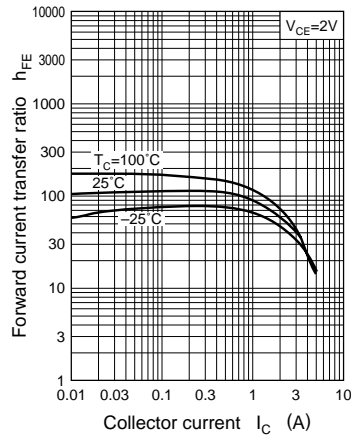

$f_T - I_C$

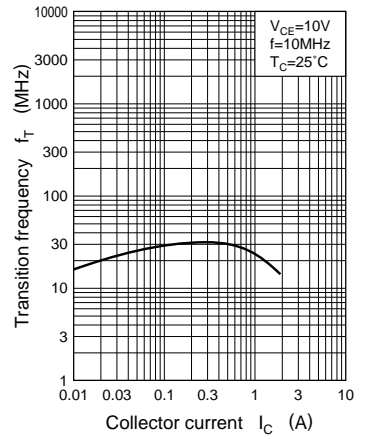

$C_{ob} - V_{CB}$

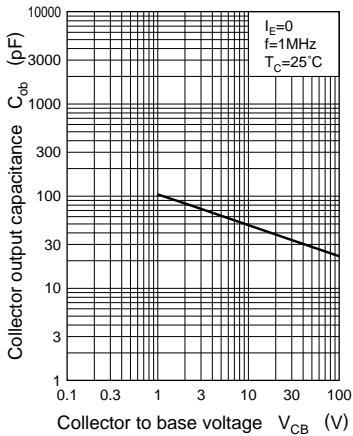

$t_{on}, t_{stg}, t_f - I_C$

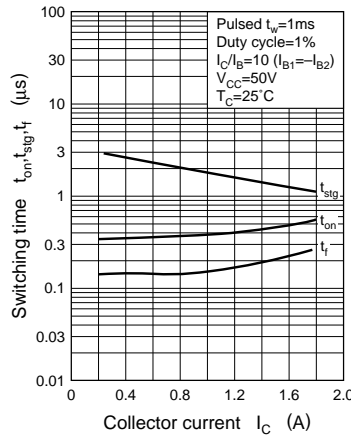

Area of safe operation (ASO)

