

2mm Pitch Miniature Connector for HDD

A3E Series

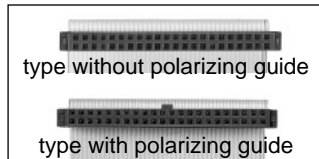
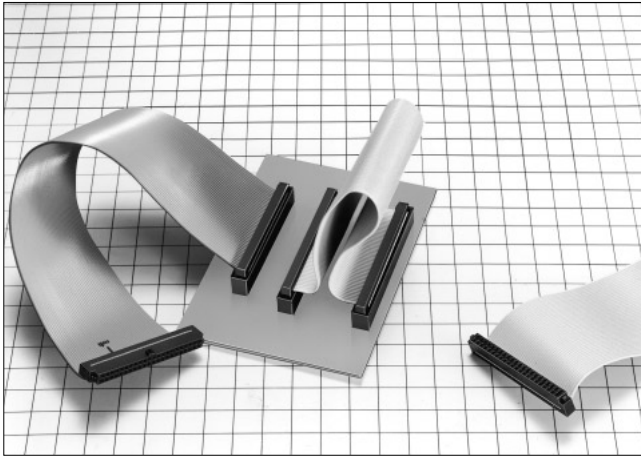

■Features

1. Variation in Number of Contacts

This connector can be chosen according to applications, using together with other series products as follows:

- (1) Cable crimping type (A3B series)
- (2) Cable ID type (A3E series)
- (3) FFC connection type (MA18 series, A3C series)

(However, the A3E series pin header corresponds to the A3E series socket only.)

On the other hand, 44 contacts are available for AT bus connection, and 55 contacts for SCSI connection.

2. Batch Insulation Displacement

1 mm pitch ribbon cable can be insulated and displaced.

3. Mechanism to Prevent Mis-insertion

The connector on the socket side contains a mechanism to prevent mis-insertion in the connector on the header side.

■Product Specifications

Rating	Current rating: 0.5A	Operating Temperature Range:-55 to +85°C (Note 1)	Storage Temperature Range:-10 to +60°C (Note 2)
	Voltage rating: 125V AC	Operating Moisture Range:40 to 80%	Storage Humidity Range:40 to 70% (Note 2)

Item	Specification	Condition
1. Insulation Resistance	1000M ohms min.	250V DC
2. Withstanding voltage	No flashover or insulation breakdown.	300V AC/1 minute
3. Contact Resistance	40m ohms max.	0.1A
4. Vibration	No electrical discontinuity of 1 μ s or more	Frequency: 10 to 55 Hz, single amplitude of 0.75 mm, 2 hours in each of the 3 directions.
5. Humidity (Steady state)	Insulation resistance: 1000M ohms min.	96 hours at temperature of 40°C and humidity of 90% to 95%
6. Temperature Cycle	No damage, cracks, or parts looseness.	(-65°C: 30 minutes →15 to 35°C: 5 minutes max. → 125°C: 30 minutes →15 to 35°C: 5 minutes max.) 5 cycles
7. Durability (Mating/un-mating)	Contact resistance: 50m ohms max.	100 cycles
8. Resistance to Soldering heat	No deformation of components affecting performance.	Flow: 260°C for 10 seconds Manual soldering: 300°C for 3 seconds

Note 1: Includes temperature rise caused by current flow.

Note 2: The term "storage" refers to products stored for long period of time prior to mounting and use. Operating Temperature Range and Humidity range covers non conducting condition of installed connectors in storage, shipment or during transportation.

■Material

Part		Material	Finish	Remarks
Insulator	Pin header	Polyamid	Black	UL94V-0
	Socket	PBT		
Contact	Pin header	Brass	Selective gold plated	_____
	Socket	Beryllium copper	Gold plated	

■ Ordering Information

● Pin Header

$\frac{A}{1} \frac{3}{2} \frac{E}{3} - \frac{*}{4} \frac{P}{5} \frac{A}{6} - \frac{2}{7} \frac{DSA}{8}$

① Series Name : A
② Series No.: 3 : double row
③ E: Box type housing
④ Number of contacts: 44, 50
⑤ P: Pin header
⑥ A: Selective gold plated
⑦ Contact pitch : 2mm
⑧ Contact type: DSA : Straight dip type

● Socket

$\frac{A}{1} \frac{3}{2} \frac{E}{3} - \frac{*}{4} \frac{D}{5} - \frac{2}{6} \frac{R}{7}$

① Series Name : A
② Series No. 3E : With polarizing guide 3EA : Without polarizing guide
③ Number of contacts: 44, 50
④ D: Receptacle
⑤ Contact pitch: 2mm
⑥ Connection type: R : ID type

■ Pin Header

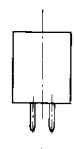
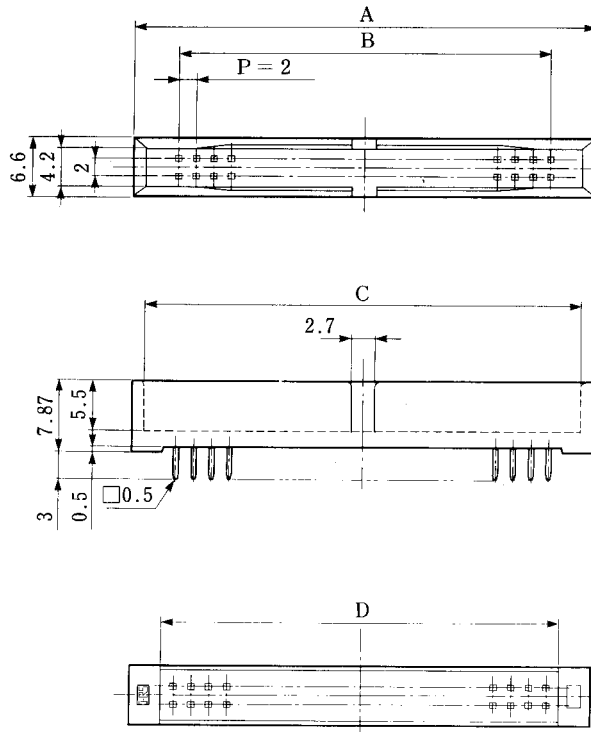
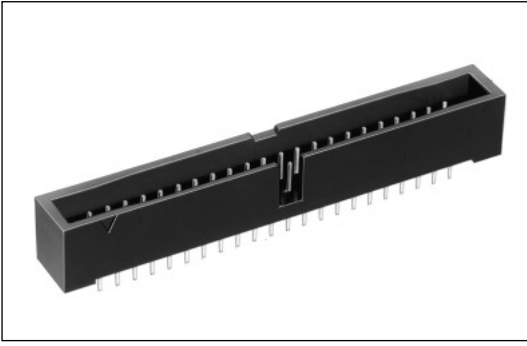

◆ PCB mounting pattern

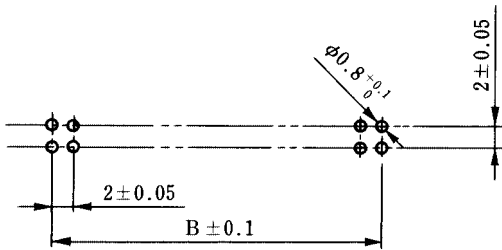

Unit: mm

Part Number	CL No.	A	B	C	D
A3E-44PA-2DSA	621-0911-8	52.0	42.0	49.2	45.0
A3E-50PA-2DSA	621-0914-6	58.0	48.0	55.2	51.0

■Socket

- Type with polarizing guide to prevent mis-insertion (A3E)

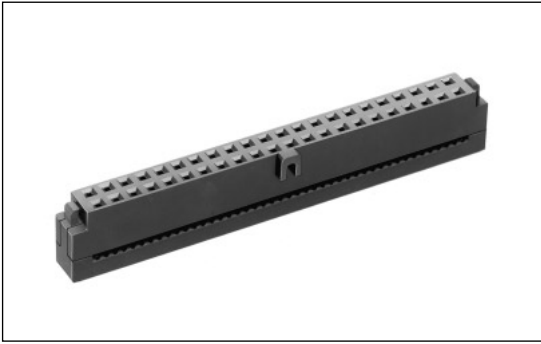

Body

Protector

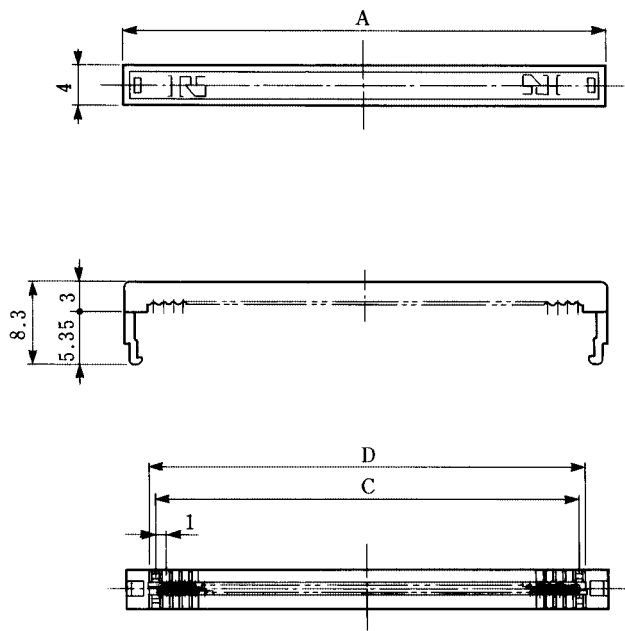
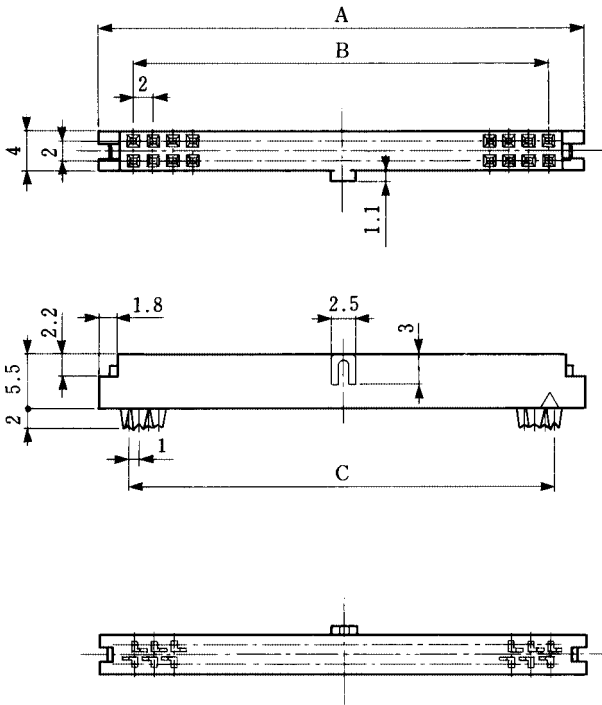

Combination View

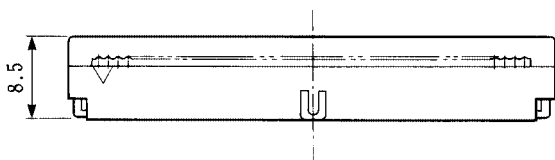

Unit: mm

Part Number	CL No.	A	B	C	D
A3E-44D-2R	621-0811-3	49.0	42.0	43.0	44.3
A3E-50D-2R	621-0814-1	55.0	48.0	49.0	50.3

●Type without polarizing guide to prevent false-insertion (A3EA)

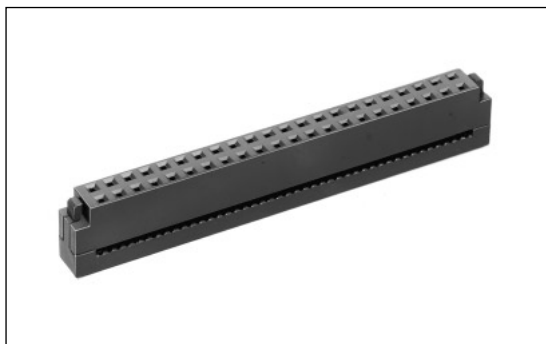

Body

Protector

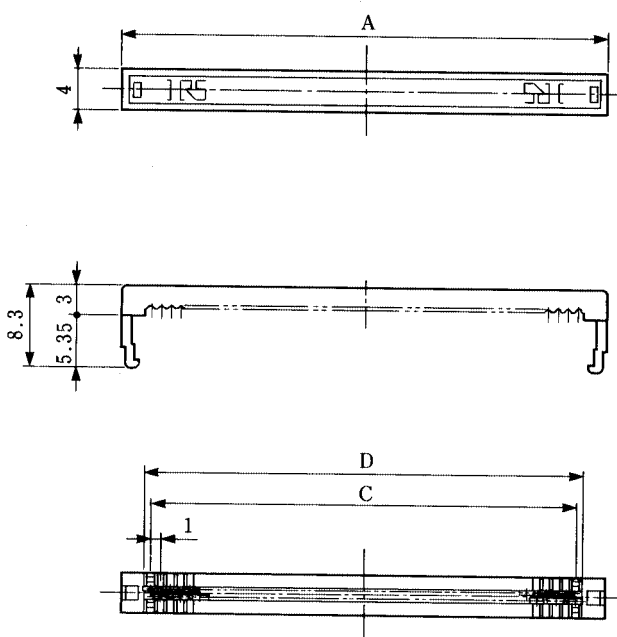
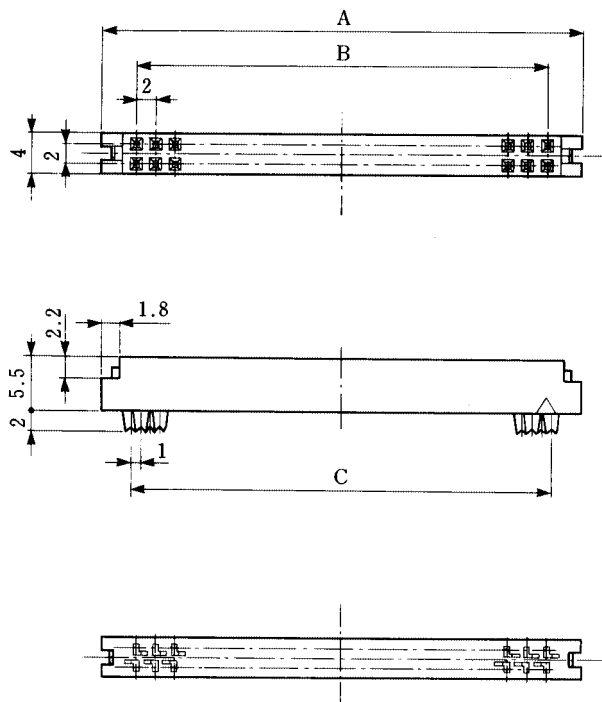

Combination View

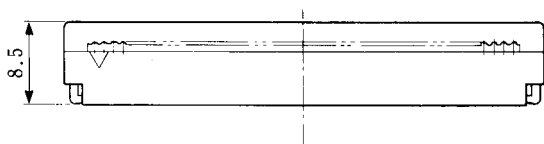

Unit: mm

Part Number	CL No.	A	B	C	D
A3EA-44D-2R	621-0861-1	49.0	42.0	43.0	44.3
A3EA-50D-2R	621-0864-0	55.0	48.0	49.0	50.3

■ Recommended Cable for A3E Socket

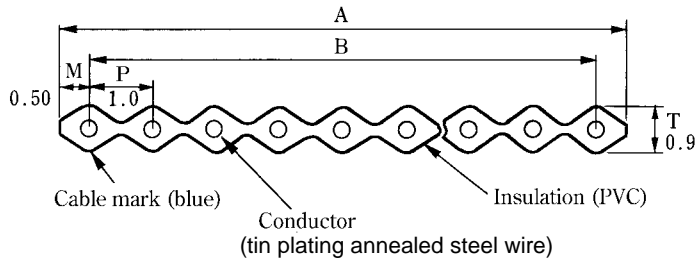

Ribbon Cable

Number of Contacts	Core wire Construction (pc./mm)	A	B
44	7/0.127	44	43
50	7/0.127	50	49

◆ Table of A3E Series Connection Tools

● Connection Press

Part Number: HI-FLEX Connection Press HHP502
CL550-0082-2



● Pressing Block

Part Number: Pressing Block A-01
CL550-0133-1

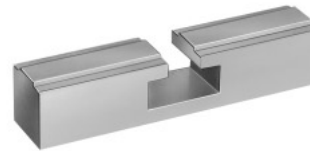

● Applicator

Universal Guide Plate
Part Number: A3E-GPA
CL550-0216-7

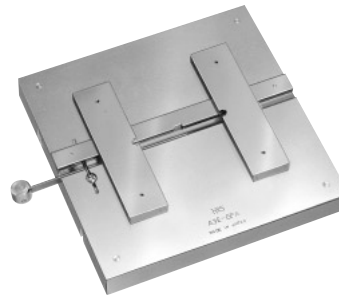

MA18 Series

The MA18 series is a 2mm pitch FFC socket connector developed for miniature HDD and main port connection. 44 contacts are provided for AT bus connection.

■ Ordering Information

MA18A - 44 D A - 2 DSE
① ② ③ ④ ⑤ ⑥

① Series Name : MA18A	⑥ Contact type (Straight type)
② Number of contacts : 32, 44	DSA : Dip length 3mm
③ Contact alignment : D : Double row	DSB : Dip length 2.5mm
④ Contact plating type A : Selective gold plated	DSC : Dip length 2mm
⑤ Contact pitch : 2mm	DSE : Dip length 1.2mm

■ Variation in Number of Contacts

Part Number	CL No.	Remarks
MA18 -32DA-2DSE	—	With extraction tab
MA18 -44DA-2DSC	588-0252-3	With extraction tab
MA18 -44DA-2DSE	588-0246-0	With extraction tab
MA18A-44DA-2DSA	588-0247-3	No extraction tab
MA18A-44DA-2DSB	588-0255-1	No extraction tab
MA18A-44DA-2DSC	588-0253-6	No extraction tab
MA18A-44DA-2DSE	588-0251-0	No extraction tab
MA18M-44DA-2DSB	588-0291-5	High profile mount type

Remark 1. The extraction tab is used to remove a cable nut in the engagement state.

2. 32 contacts = 0.76 μ and 40 contacts = 0.2 μ in the plating thickness.

■ Pin Heade

(1) Conventional product (used as conventional HDD interface pin header)

- Straight through hole type (see catalog page C15)



44 contacts : A3C-44P-2DSA (see photo)
50 contacts : A3C-50P-2DSA

- Straight SMT type (see catalog page C22)

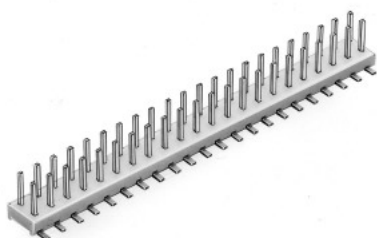

44 contacts : A3-44PA-2SV (see photo)
50 contacts : A3-50PA-2SV
(With boss type available)

- Right angle through hole type (see catalog page C13)

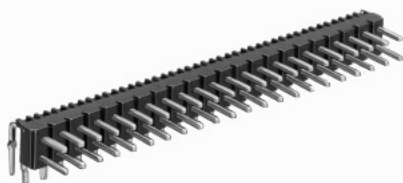

44 contacts : A3B-44PA-2DS (see photo)
50 contacts : A3B-50PA-2DS

(2) Box type product (Socket side prevents mis-insertion)

- Straight through hole type(see catalog page C28)

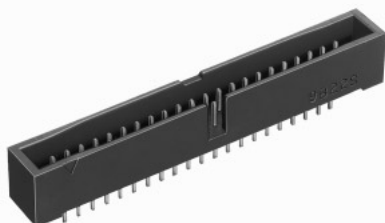

44 contacts : A3E-44PA-2DSA (see photo)
50 contacts : A3E-50PA-2DSA
Note: Correspond to A3E series socket only.

■Socket

(1) Products suitable to various cables

- Discrete wire Crimping Type (see catalog page C19)

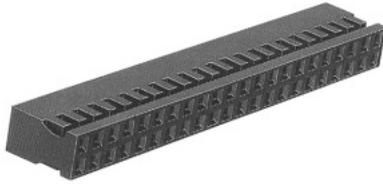

44 contacts: A3B-44D-2C
Crimping contacts and crimping tools are detailed on page C20.

- Ribbon Cable (1mm pitch) Batch ID Type (see catalog page C29)

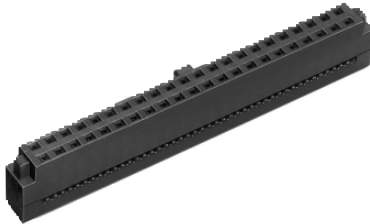

44 contacts: A3E-44D-2R (see photo)
50 contacts: A3E-50D-2R
Insulation displacement is detailed on page C31.

- FPC Connection Type

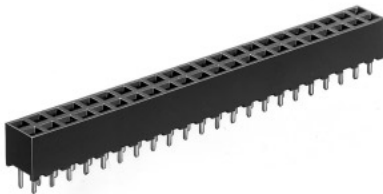

44 contacts: MA18A-44DA-1SE (photo)

(For a typical example, products are provided corresponding to various board thickness. For details, refer to page C32.)

50 contacts: A3E-50D-2R

(For a typical example, products are provided corresponding to various board thickness. For details, refer to page C17.)

(2) Right Angle through hole Type (see catalog page C15.)

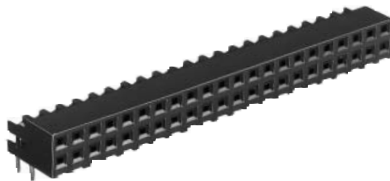

44 contacts: A3-44DA-2DS (see photo)
50 contacts: A3-50DA-2DS

(3) Straight through hole Type

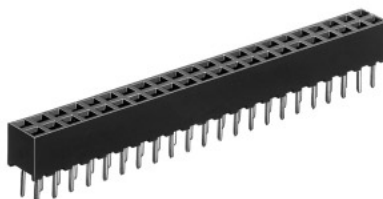

44 contacts: MA18A-44DA-2DSS (see photo)
(See catalog page C32.)
50 contacts: A3C-50DA-2DSA (see catalog page C17.)