

# Current Sensor: ACS752SCA-050

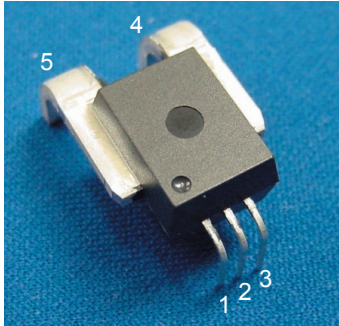

Pin 1:  $V_{CC}$       Terminal 4:  $I_{p+}$   
Pin 2: Gnd        Terminal 5:  $I_{p-}$   
Pin 3: Output

## ABSOLUTE MAXIMUM RATINGS

Operating Temperature	
S .....	-20 to +85°C
Supply Voltage, $V_{CC}$ .....	16 V
Output Voltage .....	16 V
Output Current Source .....	3 mA
Output Current Sink .....	10 mA
Maximum Storage Temperature .....	170°C
Maximum Junction Temperature .....	165°C

Always order by complete part number:

**ACS752SCA-050**



The Allegro ACS752 family of current sensors provides economical and precise solutions for current sensing in industrial, commercial, and communications systems. The device package allows easy implementation by the customer. Typical applications include: motor control, load detection and management, switched mode power supplies, and overcurrent fault protection.

The sensor consists of a precision linear Hall IC, which is optimized to an internal magnetic circuit to increase device sensitivity. The combination of a precisely controlled self-aligning assembly process (patents pending), and the factory programmed precision of the linear Hall sensor, result in high-level performance and product uniformity.

The primary conductor used for current sensing (terminals 4 and 5) is designed for extremely low power loss. These power terminals also are electrically isolated from the sensor leads (pins 1, 2, and 3). This allows the ACS752 family of sensors to be used in applications requiring electrical isolation, without using optoisolators or other costly isolation techniques.

The output of this device has a positive slope ( $>V_{CC}/2$ ) when an increasing current flows from terminal 4 to terminal 5.

The ACS752 family is lead-free. All leads are coated with 100% matte tin, and there is no lead inside the package. The heavy gauge leadframe is made of oxygen-free copper.

## Features and Benefits

- Monolithic Hall IC for high reliability
- Single +5 V supply
- High isolation voltage
- Lead-free
- UL recognized
- End-of-line factory-trimmed for gain and offset
- Ultra-low power loss: low resistance of primary conductor
- Ratiometric output from supply voltage
- Low thermal drift of offset voltage
- On-chip transient protection
- Small package size, with easy mounting capability

## Applications

- Industrial systems
- Motor control
- Power distribution
- Battery powered systems
- Electric vehicles

# Current Sensor: ACS752SCA-050

Functional Block Diagram

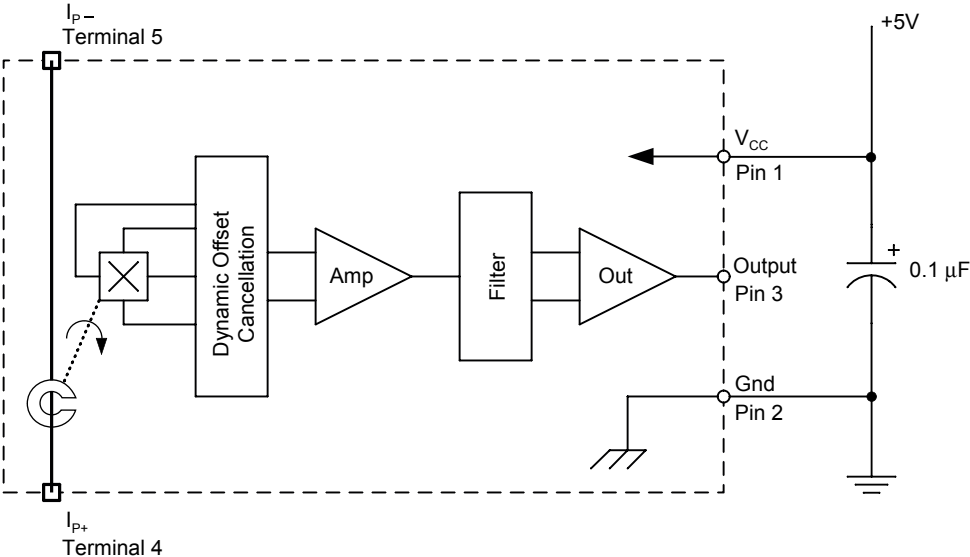

# Current Sensor: ACS752SCA-050

## ELECTRICAL CHARACTERISTICS, over temperature unless otherwise stated

Characteristic	Symbol	Test Conditions	Min.	Typ.	Max.	Units
Primary Sensed Current	$I_P$		-50	-	50	A
Supply Voltage	$V_{CC}$		4.5	5.0	5.5	V
Supply Current	$I_{CC}$	$V_{CC} = 5.0$ V, output open	-	7	10	mA
Output Resistance	$R_{OUT}$	$I_{OUT} = 1.2$ mA	-	1	2	$\Omega$
Primary Conductor Resistance	$R_{PRIMARY}$	$I_P = \pm 100$ A, $T_A = 25^\circ$ C	-	130	-	$\mu\Omega$
Isolation Voltage	$V_{ISO}$	Pins 1-3 and 4-5, 60 Hz, 1 minute	3.0	-	-	kV
<b>PERFORMANCE CHARACTERISTICS, <math>-20^\circ</math>C to <math>+85^\circ</math>C, <math>V_{CC} = 5</math> V unless otherwise specified</b>						
Propagation time	$t_{PROP}$	$I_P = \pm 50$ A, $T = 25^\circ$ C	-	4	-	$\mu$ s
Response time	$t_{RESPONSE}$	$I_P = \pm 50$ A, $T = 25^\circ$ C	-	8	-	$\mu$ s
Rise time	$t_r$	$I_P = \pm 50$ A, $T = 25^\circ$ C	-	7	-	$\mu$ s
Frequency Bandwidth	f	-3 dB, $T = 25^\circ$ C	-	50	-	kHz
Sensitivity	Sens	$\pm I_P$ , $T = 25^\circ$ C	38.0	40.0	42.0	mV/A
		$\pm I_P$	37.0	-	42.5	mV/A
Noise	$V_{NOISE}$	Peak-to-peak, $T = 25^\circ$ C, no external filter	-	75	-	mV
Nonlinearity	$E_{LIN}$	$\pm I_P$	-	-	$\pm 4$	%
Symmetry	$E_{SYM}$	$\pm I_P$	97.5	100	102.5	%
Zero Current Output Voltage	$V_{OUT(Q)}$	$I = 0$ A, $T = 25^\circ$ C	-	2.5	-	V
Electrical Offset Voltage (Magnetic error not included)	$V_{OE}$	$I = 0$ A, $T = 25^\circ$ C	-40	-	40	mV
		$I = 0$ A	-60	-	60	mV
Magnetic Offset Error	$V_{OM}$	$I = 0$ A, after excursion of 100 A	-	$\pm 0.3$	$\pm 0.65$	A
Total Output Error (Including all offsets)	$E_{TOT}$	$\pm I_P$ , $T = 25^\circ$ C	-	$\pm 1$	-	%
		$\pm I_P$	-	-	$\pm 7.5$	%

# Current Sensor: ACS752SCA-050

## Typical Performance Characteristics

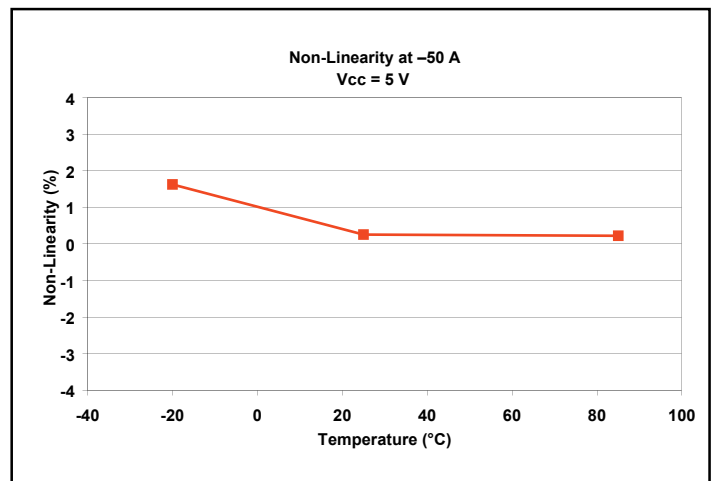
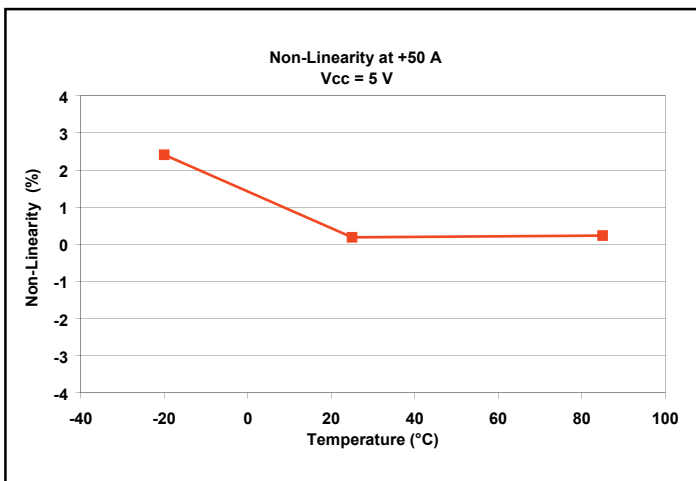
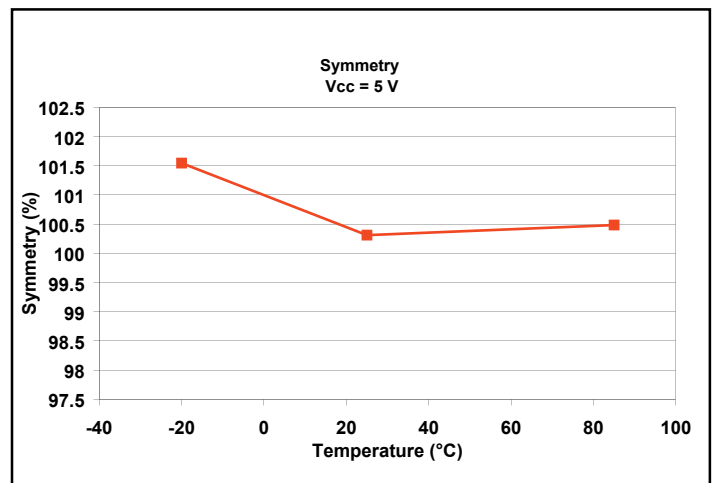
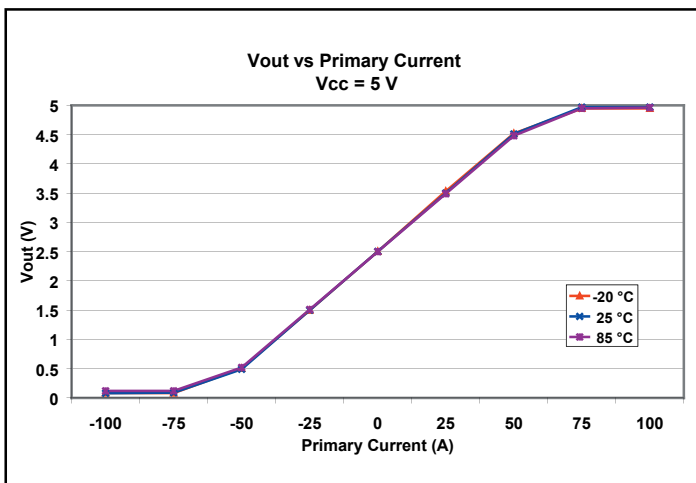
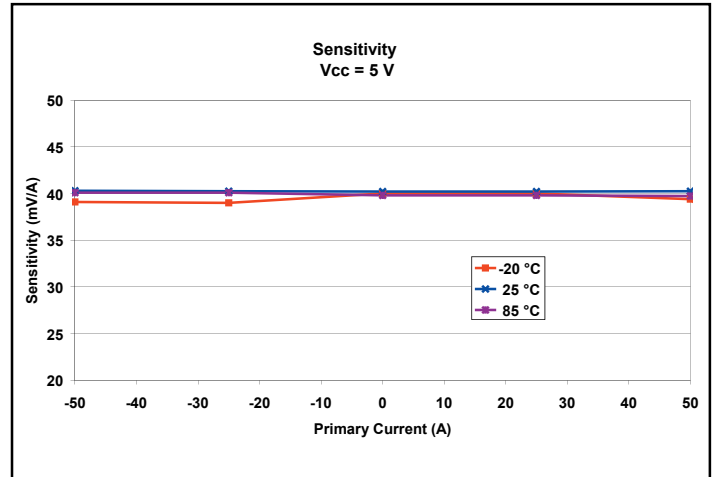
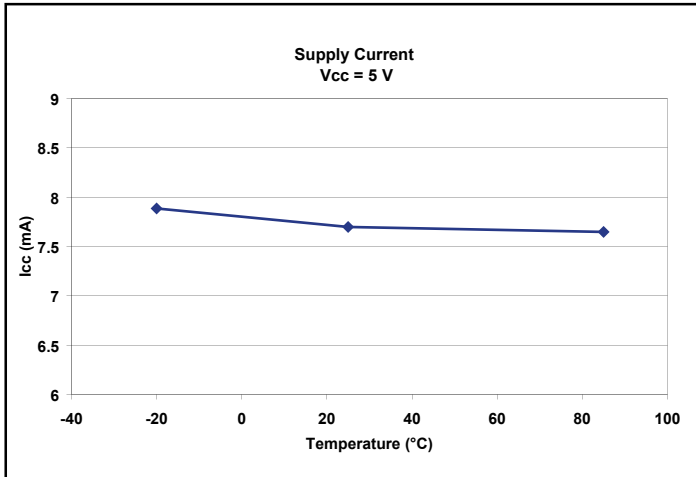

# Current Sensor: ACS752SCA-050

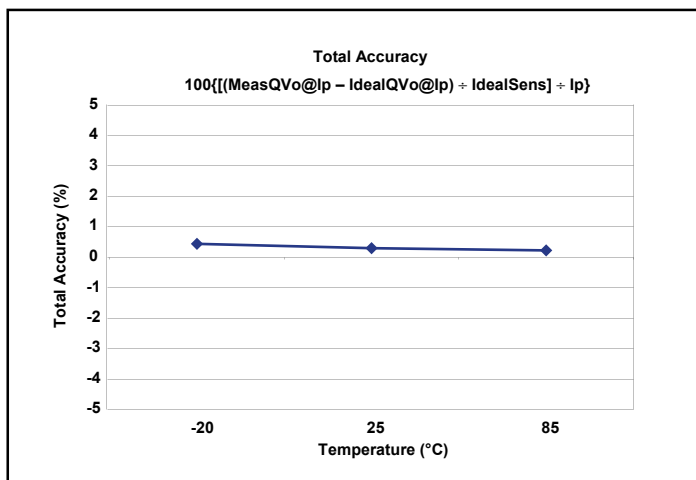
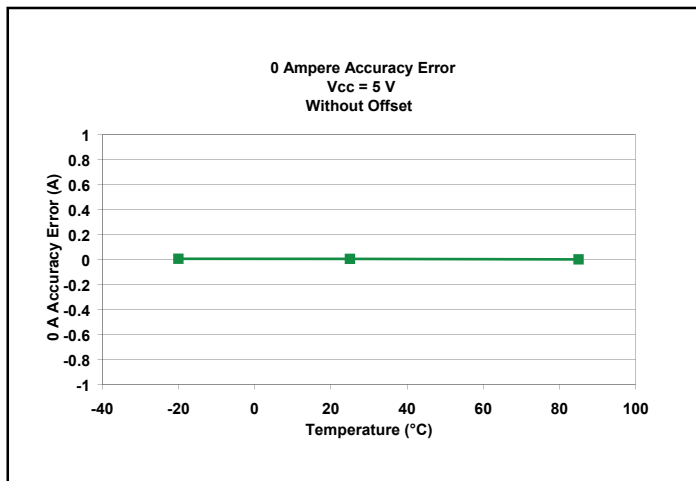
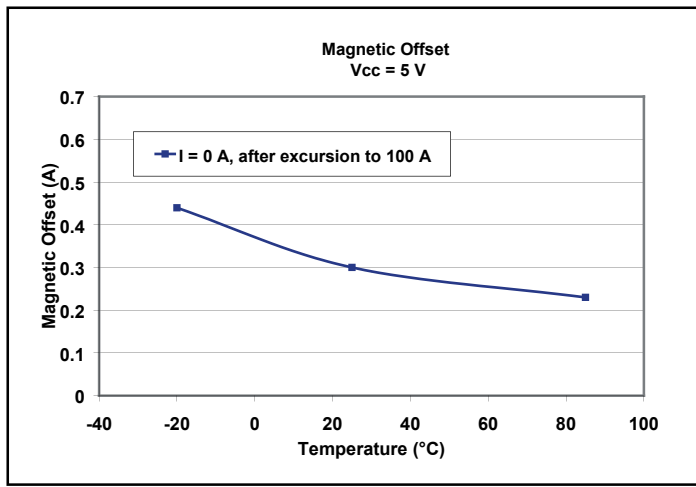

# Current Sensor: ACS752SCA-050

## Definitions of Accuracy Characteristics

**Sensitivity (Sens):** The change in sensor output in response to a 1 A change through the primary conductor. The sensitivity is the product of the magnetic circuit sensitivity (G/A) and the linear IC amplifier gain (mV/G). The linear IC amplifier gain is trimmed at the factory to optimize the sensitivity (mV/A) for the full-scale current of the device.

**Noise ( $V_{\text{NOISE}}$ ):** The product of the linear IC amplifier gain (mV/G) and the noise floor for the Allegro Hall effect linear IC ( $\approx 1$  G). The noise floor is derived from the thermal and shot noise observed in Hall elements. Dividing the noise (mV) by the sensitivity (mV/A) provides the smallest current that the device is able to resolve.

**Linearity ( $E_{\text{LIN}}$ ):** The degree to which the voltage output from the sensor varies in direct proportion to the primary current through its full-scale amplitude. Linearity reveals the maximum deviation from the ideal transfer curve for this transducer. Nonlinearity in the output can be attributed to the gain variation across temperature and saturation of the flux concentrator approaching the full-scale current. The following equation is used to derive the linearity:

$$100 \left\{ 1 - \left[ \frac{\Delta \text{ gain} \times \% \text{ sat} (V_{\text{out\_full-scale amperes}} - V_{\text{OUT(Q)}})}{2 (V_{\text{out\_half-scale amperes}} - V_{\text{OUT(Q)}})} \right] \right\}$$

where

$\Delta$  gain = the gain variation as a function of temperature changes from 25°C,

% sat = the percentage of saturation of the flux concentrator, which becomes significant as the current being sensed approaches full-scale  $\pm I_p$ , and

$V_{\text{out\_full-scale amperes}}$  = the output voltage (V) when the sensed current approximates full-scale  $\pm I_p$ .

**Symmetry ( $E_{\text{SYM}}$ ):** The degree to which the absolute voltage output from the sensor varies in proportion to either a positive or negative full-scale primary current. The following equation is used to derive symmetry:

$$100 \left[ \frac{V_{\text{out\_+full-scale amperes}} - V_{\text{OUT(Q)}}}{V_{\text{OUT(Q)}} - V_{\text{out\_full-scale amperes}}} \right]$$

**Quiescent output voltage ( $V_{\text{OUT(Q)}}$ ):** The output of the sensor when the primary current is zero. For a unipolar supply voltage, it nominally remains at  $V_{\text{CC}}/2$ . Thus,  $V_{\text{CC}} = 5$  V translates into  $V_{\text{OUT(Q)}} = 2.5$  V. Variation in  $V_{\text{OUT(Q)}}$  can be attributed to the resolution of the Allegro linear IC quiescent voltage trim, magnetic hysteresis, and thermal drift.

**Electrical offset voltage ( $V_{\text{OE}}$ ):** The deviation of the device output from its ideal quiescent value of  $V_{\text{CC}}/2$  due to nonmagnetic causes.

**Magnetic offset error ( $V_{\text{OM}}$ ):** The magnetic offset is due to the residual magnetism (remnant field) of the core material. The magnetic offset error is highest when the magnetic circuit has been saturated, usually when the device has been subjected to a full-scale or high-current overload condition. The magnetic offset is largely dependent on the material used as a flux concentrator. The larger magnetic offsets are observed at the lower operating temperatures.

**Accuracy ( $E_{\text{TOT}}$ ):** The accuracy represents the maximum deviation of the actual output from its ideal value. This is also known as the total output error. The accuracy is illustrated graphically in the Output Voltage versus Current chart on the following page.

Accuracy is divided into four areas:

- **0 A at 25°C:** Accuracy of sensing zero current flow at 25°C, without the effects of temperature.
- **0 A over temperature:** Accuracy of sensing zero current flow including temperature effects.
- **Full-scale current at 25°C:** Accuracy of sensing the full-scale current at 25°C, without the effects of temperature.
- **Full-scale current over  $\Delta$  temperature:** Accuracy of sensing full-scale current flow including temperature effects.

# Current Sensor: ACS752SCA-050

Output voltage vs. current, illustrating sensor accuracy at 0 A and at full-scale current

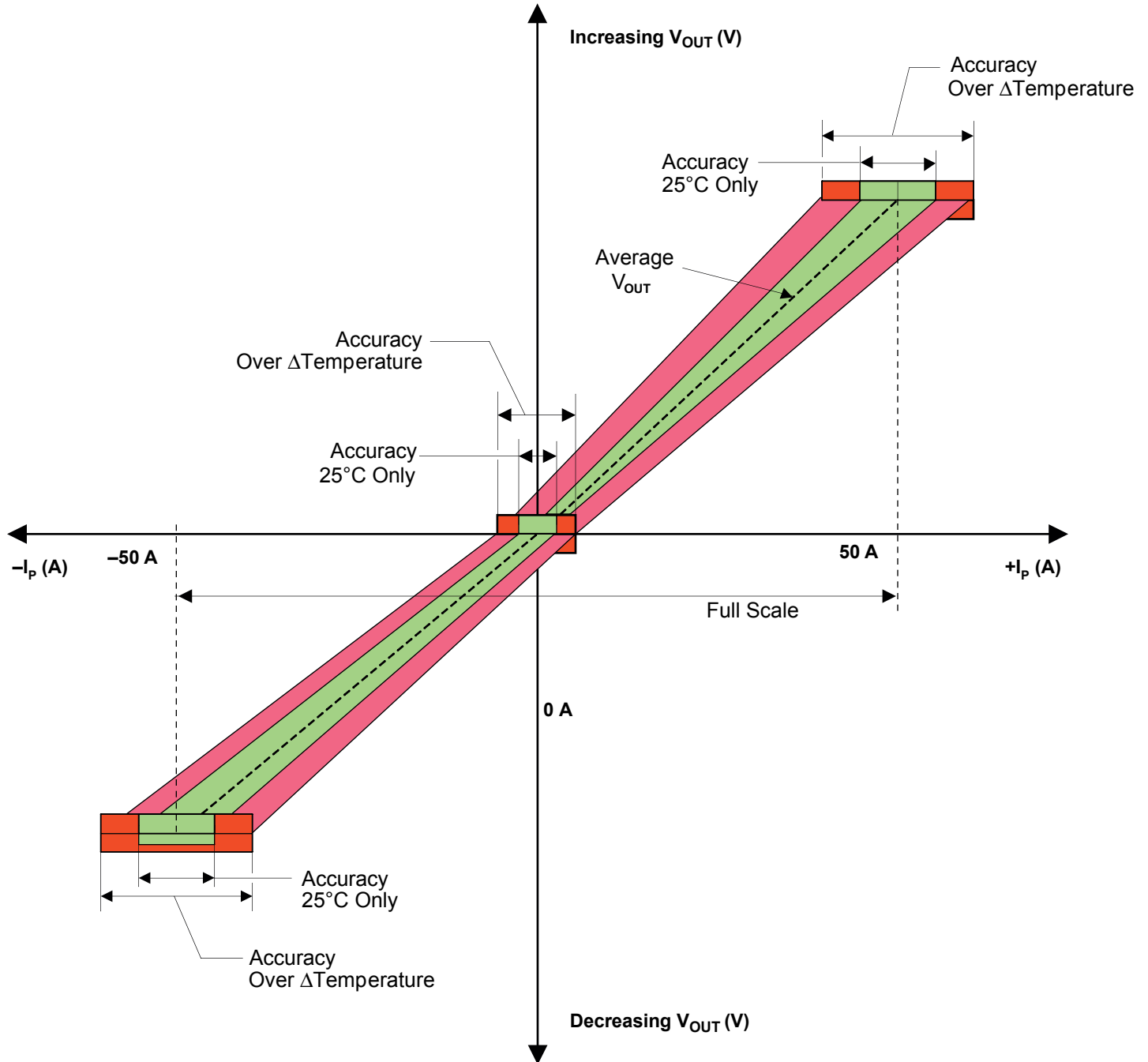

# Current Sensor: ACS752SCA-050

## Definitions of Dynamic Response Characteristics

**Propagation delay ( $t_{PROP}$ ):** The time required for the sensor output to reflect a change in the primary current signal. Propagation delay is attributed to inductive loading within the linear IC package, as well as in the inductive loop formed by the primary conductor geometry. Propagation delay can be considered as a fixed time offset and may be compensated.

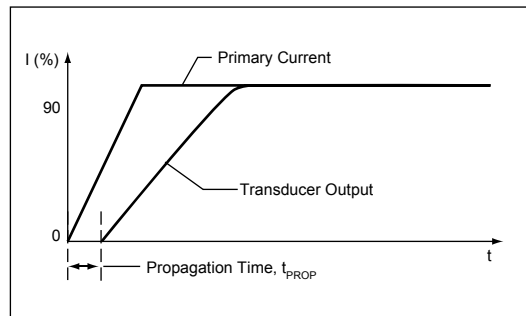

**Response time ( $t_{RESPONSE}$ ):** The time interval between a) when the primary current signal reaches 90% of its final value, and b) when the sensor reaches 90% of its output corresponding to the applied current.

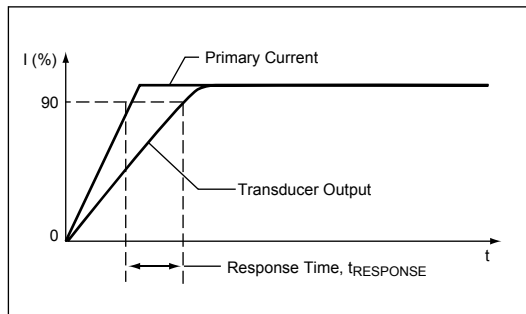

**Rise time ( $t_r$ ):** The time interval between a) when the sensor reaches 10% of its full scale value, and b) when it reaches 90% of its full scale value. The rise time to a step response is used to derive the bandwidth of the current sensor, in which  $f(-3 \text{ dB}) = 0.35 / t_r$ . Both  $t_r$  and  $t_{RESPONSE}$  are detrimentally affected by eddy current losses observed in the conductive IC ground plane and, to varying degrees, in the ferrous flux concentrator within the current sensor package.

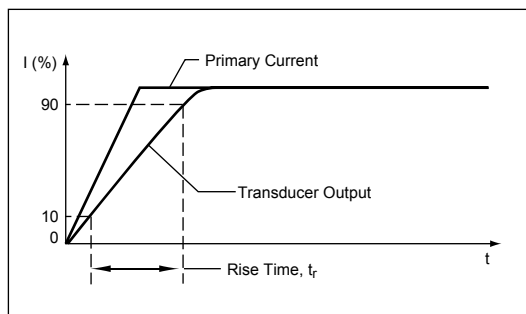



# Current Sensor: ACS752SCA-050

## Standards and Physical Specifications

Parameter	Specification
Flammability (package molding compound)	UL recognized to UL 94V-0
Creepage distance, current terminals to sensor pins	7.25 mm
Clearance distance, current terminals to sensor pins	7.25 mm
Package mass	4.18 g typical

## Step Response, $I_{\text{PRIMARY}} = 0$ to 30 A

1-Mar-04  
20:58:33

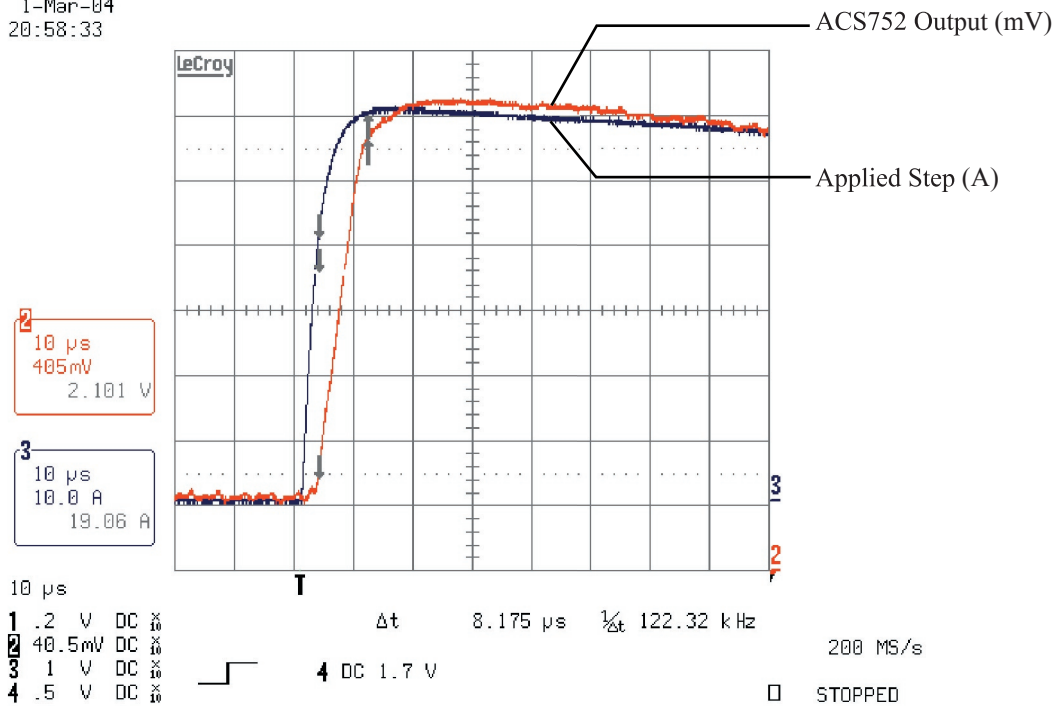

# Current Sensor: ACS752SCA-050

## Package CA

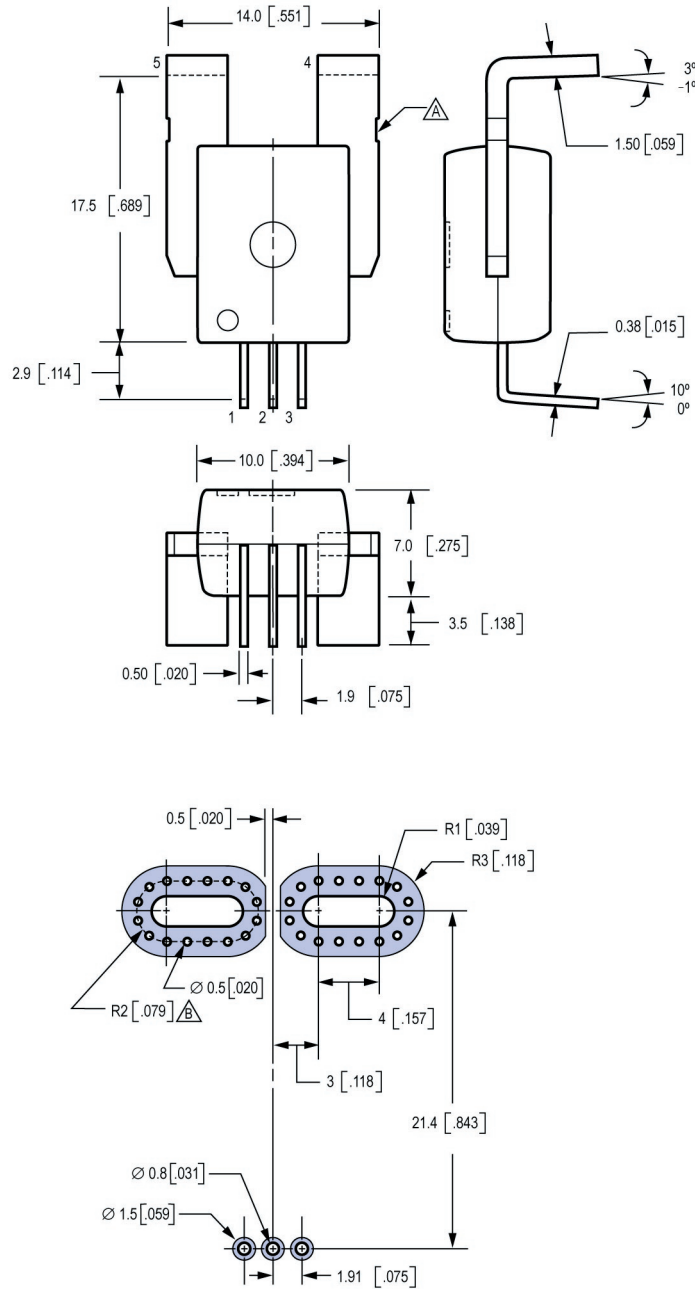

Dimensions in millimeters. Untoleranced dimensions are nominal.  
U.S. Customary dimensions (in.) in brackets, for reference only

△ Dambar removal intrusion

△ Perimeter through-holes recommended

# Current Sensor: ACS752SCA-050

*The products described herein are manufactured under one or more of the following U.S. patents: 5,045,920; 5,264,783; 5,442,283; 5,389,889; 5,581,179; 5,517,112; 5,619,137; 5,621,319; 5,650,719; 5,686,894; 5,694,038; 5,729,130; 5,917,320; and other patents pending.*

*Allegro MicroSystems, Inc. reserves the right to make, from time to time, such departures from the detail specifications as may be required to permit improvements in the performance, reliability, or manufacturability of its products. Before placing an order, the user is cautioned to verify that the information being relied upon is current.*

*Allegro products are not authorized for use as critical components in life-support devices or systems without express written approval.*

*The information included herein is believed to be accurate and reliable. However, Allegro MicroSystems, Inc. assumes no responsibility for its use; nor for any infringement of patents or other rights of third parties which may result from its use.*