

# AKD5352

## Evaluation Board Rev.B for AK5352

### General description

The AKD5352 is an evaluation board for the AK5352 digital stereo audio 20bit A/D converter. The AKD5352 includes the input buffer circuit and also has a digital interface transmitter. Further, the AKD5352 can evaluate direct interface with AKD4328, AKD4319, AKD4320 and AKD4321.

■ Ordering guide

AKD5352 --- Evaluation board for AK5352

### Function

- On-board Input Buffer Circuit
- On-board clock generator
- Compatible with 2 types of interface
  - 1) Direct interface with AKD4328, AKD4319, AKD4320 and AKD4321
  - 2) On-board CS8402 as DIT which transmitter optical output
- A BNC connector for an external clock input.

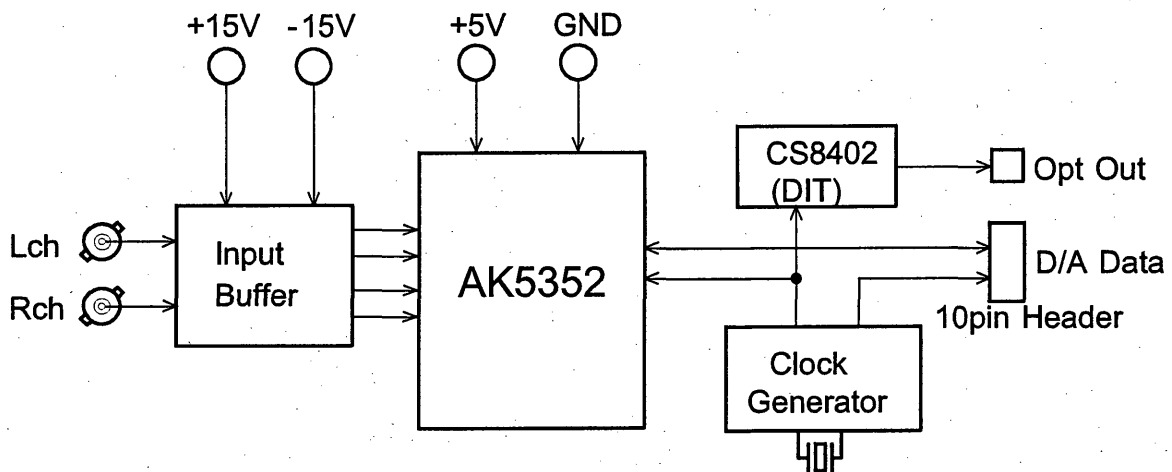
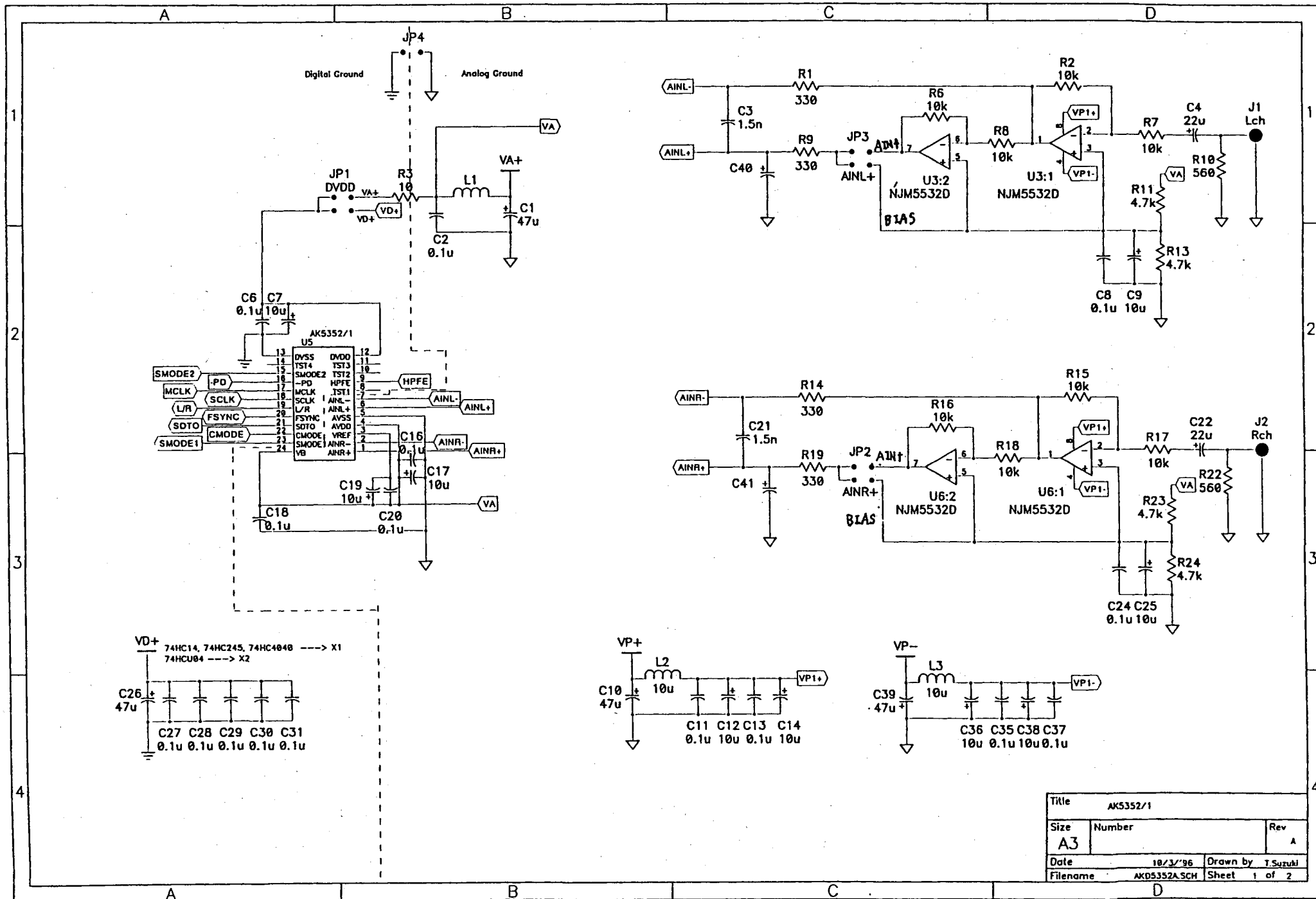
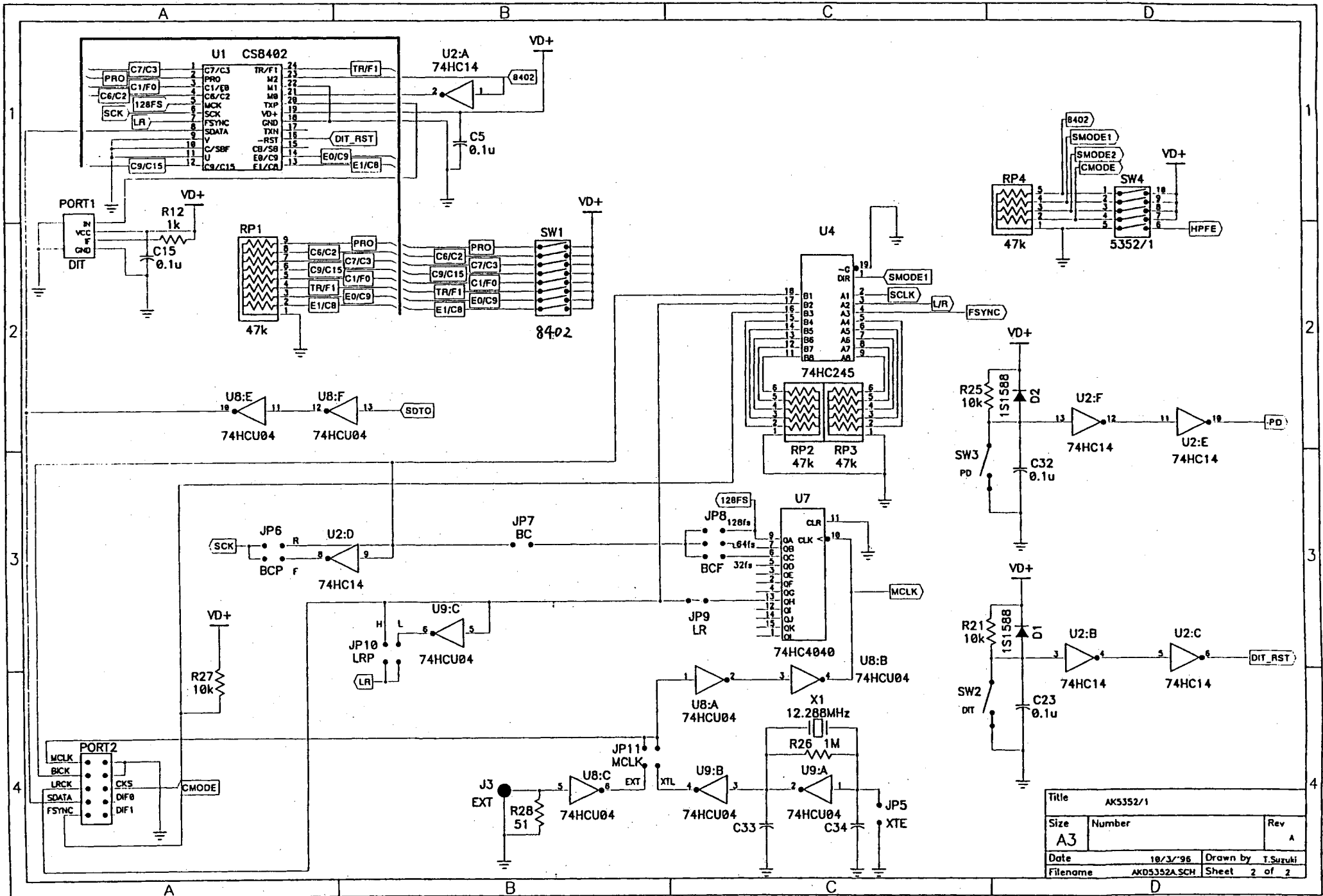

Figure 1. AKD5352 block diagram



Title			AK5352/1		
Size	Number				Rev
A3					A
Date	10/3/96		Drawn by		T.Suzuki
Filename	AKD5352A.SCH		Sheet		1 of 2



Title AK5352/1		
Size A3	Number	Rev A
Date 10/3/96	Drawn by T.Suzuki	
Filename AK05352A.SCH	Sheet 2 of 2	

■ Input buffer circuit

The AKD5352 includes single-ended circuit with an inverted-amp (gain 1) . External analog signal fed through the BNC connector is terminated by a resistor of 560 ohms. The resistor value should be properly selected in order to meet the output impedance of the signal source.

The `Cin` is an important part in the input buffer circuit design. (Example circuit:  $f_c = 150\text{kHz}$ ) . A large `Cin` can improve the distortion of the converter because it lowers the effect of feed through noise from the device. However, the larger `Cin` becomes heavier load for the input buffer amp and increases its distortion. The actual value should be decided by taking a balance between both factors. And please consider the frequency response within audio band.

Full-difference inputs (Default)

- [JP2,JP3] : AIN+
- [R1, R9, R14, R9] : 330  $\Omega$
- [C40, C41] : None
- [C3, C21] : 1.5nF

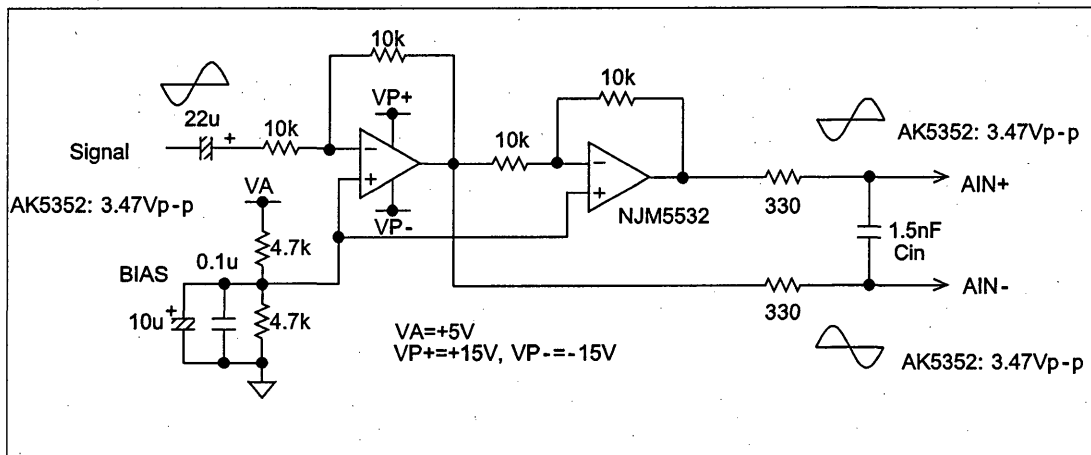

Figure 2. Full-differential Input Buffer Circuit example

\* AKM assumes no responsibility for the trouble when using the above circuit examples.

## ■ Power supply and Decoupling

VA and VD supplies to the AK5352 are decoupled separately in order to minimize the effect of the digital noise. A system analog supply is fed to VA and VB. VA and VD lines should be distributed separately from the power unit. When VD voltage exceeds 0.3V or higher than that of VA and VB, internal diode structure will be turned on, and excess current begins flowing. When VD supplies are not separated from VA and VB, VA should be powered-on at the same time or earlier than VD, and powered-off at the same time or later. Decoupling capacitors are connected to AK5352 as near as possible, particularly the ceramic capacitor to the VREF pin and VD pin. (Please refer to AKD5352 Rev.B printed pattern)

## ■ Operation sequence

### ① Set up the power supply lines

VA+=VD+= +5V,

VP+= +15V,

VP-= -15V,

AGND=DGND= 0V

Each supply line should be distributed from the power unit.

### ② Set up the evaluation modes and jumper pins. (See next item)

There are many jumper pins to cover many evaluation modes.

Please take care of setting.

### ③ Set up the DIP SW position for the DIT. (See next item)

This does not affect AK5352 operation.

### ④ Power On.

The AK5352 should be reset once by bringing  $\overline{\text{PD}}$  "L" upon power-up.

※ AK5352 can be reset by SW3 during operation.

"L" position resets the device, and the "H" position is for normal operation.

Note: In any case of changing clocks during operation, the device should be reset by bringing PD "H".  
If not followed, the AK5352 may be destroyed since its internal logic uses dynamic circuit.

■ The evaluation modes and corresponding jumper pin settings.

1. Evaluation Mode

Applicable Evaluation Mode

- ① Using D/A converter board for the analog performance analysis.
- ② DIT (Optical Link) [Default].
- ③ All interface signals (MCLK, BICK and LRCK) are fed from external circuit.
- ④ Feed all interface signals to the external circuit through PORT2.

① Using D/A converter board for the analog performance analysis.

The AK5352 can be evaluated by distortion analyzer using various AKM's D/A converter AKD4328, AKD4319, AKD4320 and AKD4321 through PORT2.

When SW4-4 (CMODE) goes "ON", AK5352 operates with 384fs clock.

[Slave mode: SMODE1=OFF]

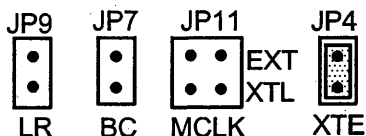
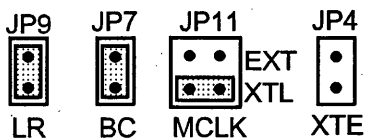

Figure 3. Jumper Set up (D/A)

② DIT (Optical Link)

PORT1 is used. DIT generates audio Bi-phase signal from received data and which is output through optical connector (TOTX174). It is possible to connect AKM's evaluation boards (AKD4328, AKD4319, AKD4320 and AKD4321) on the digital-amplifier which equips DIR input. There are two kinds of jumper setting depend on the SMODE1 pin (SW4-2). The interface signals are output from PORT2. (See the ④). In case of using external clock through a BNC connector, select EXT on JP11 (MCLK) and shorts JP4 (XTE). It does not correspond with MCLK=384fs and double speed sampling of the AK5352.

[Slave mode: SMODE1=OFF] (Default)



[Master mode: SMODE1=ON]

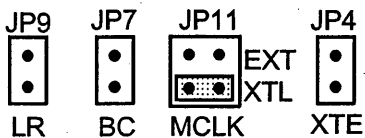

Figure 4. Jumper Set up (DIT)

- ③ All interface signals (MCLK, BICK and LRCK) are fed from external circuit. [Slave mode]  
 Under the following set-up, MCLK, BICK and LRCK signals needed for the A/D to operate could be fed through PORT2. When SW4-4 (CMODE) is "ON", the AK5352 operates with 384fs clock.

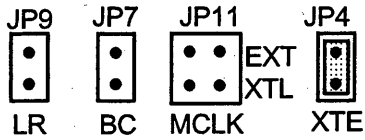

Figure 5. Jumper Set up (EXT)

- ④ Feed all interface signals to the external circuit through PORT2. [Master, Slave mode]  
 Please set up as same as ②. Generally, all interfacing signals which drive AK5352 are output through PORT2. However, the FSYNC is a input signal in slave mode. In this case the SDATA input format can be controlled by the FSYNC.

2. BIT CLOCK (BCF) Set up



[JP8] Either 32fs or 64fs for the BC can be selected. Figure shows 64fs example.  
 32: 32fs  
 64: 64fs

## 3. Jumper, DIP-SW (SW4) Set up and explanation

No.	PIN	ON	OFF
1	8402	See the Table 2	
2	SMODE1		
3	SMODE2		
4	CMODE	384fs	256fs
5	HPF	HPF off	HPF on

\* DIP-SW is ON="H", OFF="L".

Table 1. DIP-SW4 Set up

Set up the CS8402's (DIT) data format corresponding the serial data interface of the AK5352. SW4-1, JP6 and JP10 does not affect except that the DIT (CS8402) of evaluation mode ② uses.

AK5352 Data Format	SMODE1 (SW4-2)	SMODE2 (SW4-3)	8402 (SW4-1)	BCP (JP6)	LRP (JP10)
Slave Mode	OFF	OFF	OFF	F	H
Master Mode	ON	OFF	ON	R	L
I <sup>2</sup> S Slave Mode	OFF	ON	ON	R	H
I <sup>2</sup> S Master Mode	ON	ON	ON	R	H

Table 2. Serial Data Interface of AK5352, CS8402 (DIT)

[SW4-1]: CS8402's data format

OFF: MSB justified, 24bit

ON : I<sup>2</sup>S compatible

[JP6]: Define the polarity SCLK

F: BC is inverted.

R: BC coincides with AK5352

[JP10]: Define the polarity of LRCK

H: LRCK coincides with AK5352 (Slave mode)

L: LRCK is inverted. (Master mode)

[JP1]: Power supply source of VD pin can be selected. AKM recommend VD+ position.

VD+: VD pin is supplied from digital supply in system.

VA+: VD pin supplied through the resistor of 10 ohms from analog supply in system.

■ The function of the toggle SW.

[SW1] Resets the CS8402. "L" position resets the internal counter of CS8402, then Bi-phase signal is not output. Keep the "H" position during normal operation.

[SW3] Resets the AK5352. Keep the "H" position during conversion.



■ DIP switch set up. (Default is the consumer mode.)

This switch sets the C-bit of CS8402. This set up does not affect the evaluation of the AK5352. In case of using DIT, need to set it up correctly. For more detailed configurations, please refer to the CS8402 data-sheet.

Switch	OFF=0,ON=1	Contents
1	$\overline{\text{PRO}}=0$	Professional mode, C0=1
2,3	$\overline{\text{C6,C7}}$	C6,C7 - Sampling frequency
	1 1	00 - Not indicated. Receiver default to 48kHz.
	1 0	01 - 48kHz
	0 1	10 - 44.1kHz
	0 0	11 - 32kHz
4	$\overline{\text{C9}}$	C8,C9,C10,C11 - 1bit of channel mode
	1	0000 - Mode not indicated. Receiver default to 2-channel mode.
	0	0100 - Stereophonic.
5	$\overline{\text{C1}}$	C1 - Audio mode
	1	0 - Normal audio
	0	1 - Not audio
6	TRNPT	Transparent mode *CS8402 is CRE
	0	Normal mode
	1	Transparent mode
8,7	EM1,EM0	C2,C3,C4 - Encoded audio signal emphasis
	1 1	000 - Emphasis not indicated. Receiver defaults to no emphasis with manual override enable.
	1 0	100 - None
	0 1	110 - 50/15usec
	0 0	111 - CCITT J.17

Table 3 DIP switch set up of CS8402 (Professional mode)

Switch	OFF=0,ON=1	Contents
1	$\overline{\text{PRO}}=1$	Consumer mode, C0=0 (Default)
2	$\overline{\text{C2}}$	C2 - Copy
	1	0 - Copy inhibited
Default	0	1 - Copy permitted
3	$\overline{\text{C3}}$	C3,C4,C5 - Pre-emphasis
Default	1	000 - None
	0	100 - 50/15usec
4	$\overline{\text{C15}}$	C15 - Generation Status
	1	0 - See the standard
Default	0	1 - See the standard
6,5	$\overline{\text{FC1,FC0}}$	C24,C25,C26,C27- Sampling frequency
	0 0	0000 - 44.1kHz
Default	0 1	0100 - 48kHz
	1 0	1100 - 32kHz
	1 1	0000 - 44.1kHz, CD mode
8,7	$\overline{\text{C8,C9}}$	C8-C14 - Category code
Default	1 1	0000000 - General
	1 0	0100000 - PCM encoder/decoder
	0 1	1000000 - CD
	0 0	1100000 - DAT

Table 4 DIP switch set up of CS8402 (Consumer mode)

AK5352 Measurement Example

■ No.1 ROHDE & SCHWARZ, UPD04 is used.

a. Normal Speed Sampling

[Measurement Condition]

- Measurement Unit : ROHDE & SCHWARZ, UPD04
- Power Supply : VA=VD=5.0V
- Sampling Frequency (fs) : 44.1kHz & 48kHz
- MCLK: 256fs, BICK : 64fs, Slave mode
- Interface : DIT
- Temperature : Room temperature
- Bandwidth : 20 ~ 20kHz

[Measurement Result]

Parameter	Input signal	Results		Measurement Filter
		fs=48kHz	fs=44.1kHz	
THD+N	1kHz,-0.5dB	-98.5dB	-97.5dB	
DR	1kHz,-20dB	100.0dB	99.0dB	
		104.0dB	103.4dB	A-weight
DR	1kHz,-60dB	100.3dB	99.0dB	
		104.5dB	103.6dB	A-weight
S/N	1kHz,0dB/GND	100.2dB	99.0dB	
		104.5dB	104.0dB	A-weight
		100.0dB	99.5dB	CCIR-ARM

Table 5. Normal Speed Sampling

b. Double Speed Sampling

[Measurement Condition]

- Measurement Unit : ROHDE & SCHWARZ, UPD04
- Power Supply : VA=VD=5.0V
- Sampling Frequency (fs) : 96kHz
- MCLK: 256fs, BICK : 64fs, Slave mode
- Interface : 15pin D-sub connector
- Temperature : Room temperature
- Bandwidth : 40Hz ~ 40kHz

[Measurement Result]

Parameter	Input signal	Results
THD+N	1kHz,-0.5dB	-97.5dB
DR	1kHz,-20dB	98.5dB
DR	1kHz,-60dB	99.0dB
S/N	1kHz,0dB/GND	99.5dB

Table 6. Double Speed Sampling

■ Audio Precision, System One is used.

[Measurement Condition]

- Measurement Unit : Audio Precision, System One
- Power Supply : VA=VD=5.0V
- Sampling Frequency (fs) : 48kHz
- MCLK: 256fs, BICK : 64fs, Slave mode
- Interface : DIT
- Temperature : Room temperature
- Bandwidth : 20Hz ~ 22kHz

[Measurement Result]

Parameter	Input Signal	Results	Measurement Filter
THD+N	1kHz,-0.5dB	-97.0dB	
DR	1kHz,-20dB	98.0dB	
DR	1kHz,-60dB	97.8dB	
S/N	1kHz, 0dB/GND IN	97.8dB	
		102.4dB	A-weight
		99.2dB	CCIR-ARM

Table 7. Normal Speed Sampling

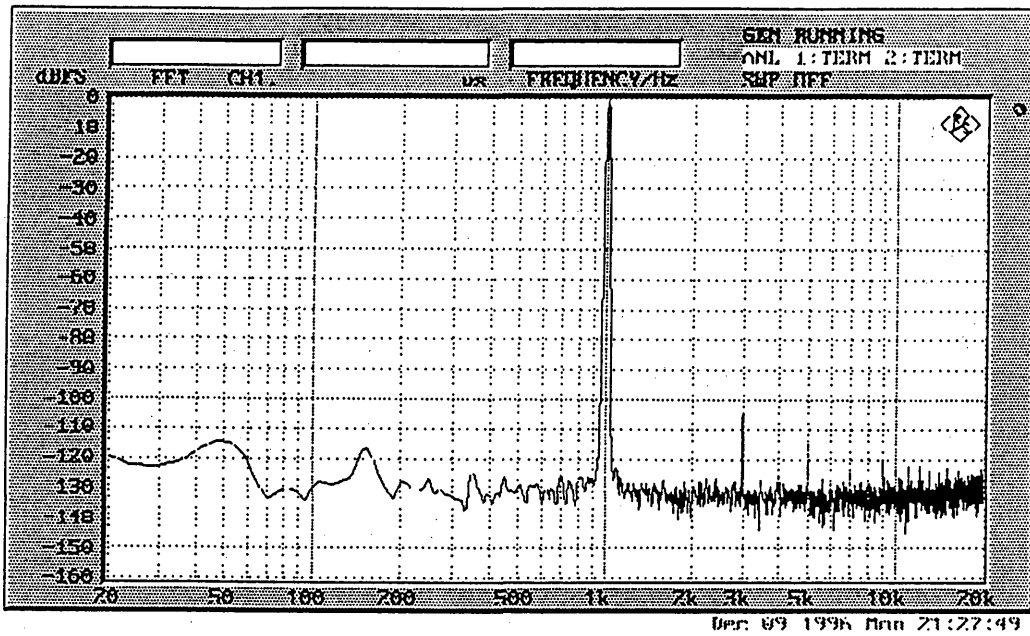

FFT plot

[Measurement Condition]

- Device: AK5352
- Measurement Unit: ROHDE&SCHWARZ,UPD04
- Power Supply: VA=VD=5.0V
- Sampling Frequency(fs): 48kHz
- MCLK: 256fs, BICK: 64fs, Slave mode
- Temperature: Room temperature
- Interface: DIT
- Points: 8192
- Averaging: 4
- Input Frequency: 1kHz
- Input Level: -0.5dB

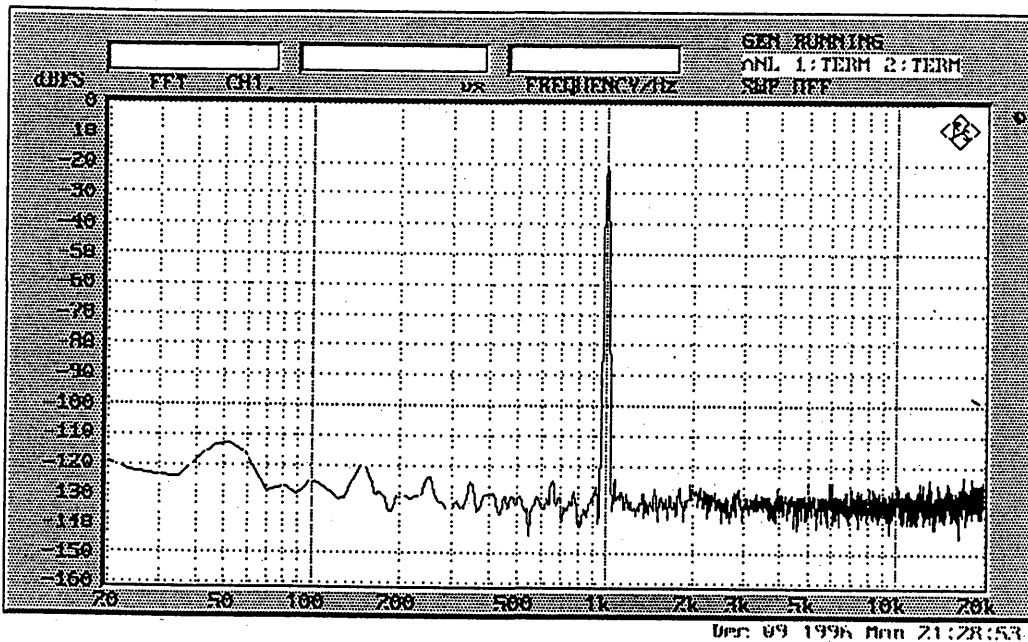

FFT plot

[Measurement Condition]

- Device: AK5352
- Measurement Unit: ROHDE&SCHWARZ,UPD04
- Power Supply: VA=VD=5.0V
- Sampling Frequency(fs): 48kHz
- MCLK: 256fs, BICK: 64fs, Slave mode
- Temperature: Room temperature
- Interface: DIT
- Points: 8192
- Averaging: 4
- Input Frequency: 1kHz
- Input Level: -20dB

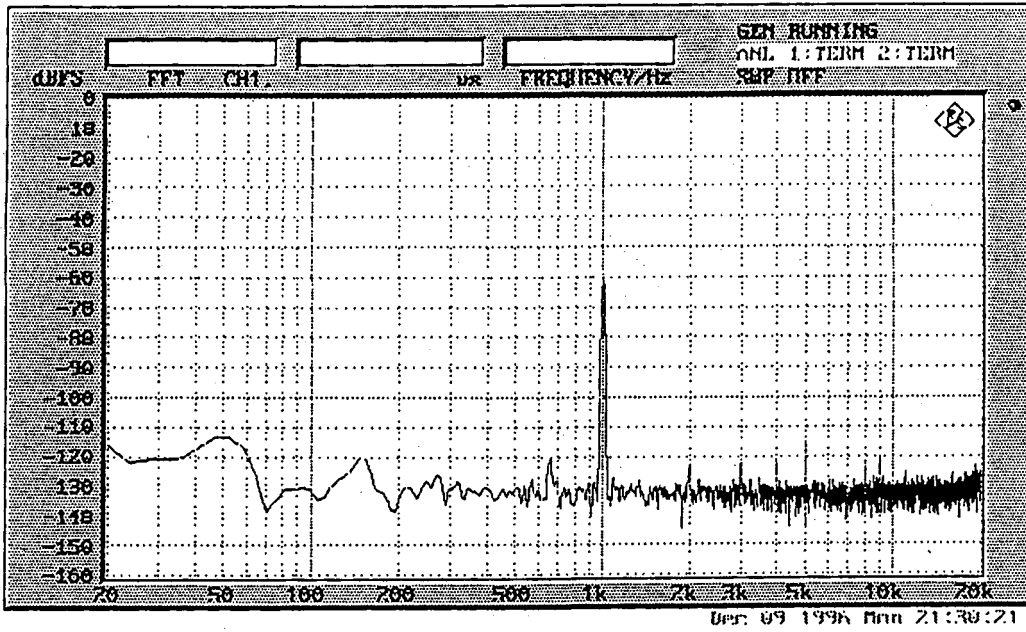

FFT plot

[Measurement Condition]

- Device: AK5352
- Measurement Unit: ROHDE&SCHWARZ,UPD04
- Power Supply: VA=VD=5.0V
- Sampling Frequency(fs): 48kHz
- MCLK: 256fs, BICK: 64fs, Slave mode
- Temperature: Room temperature
- Interface: DIT
- Points: 8192
- Averaging: 4
- Input Frequency: 1kHz
- Input Level: -60dB

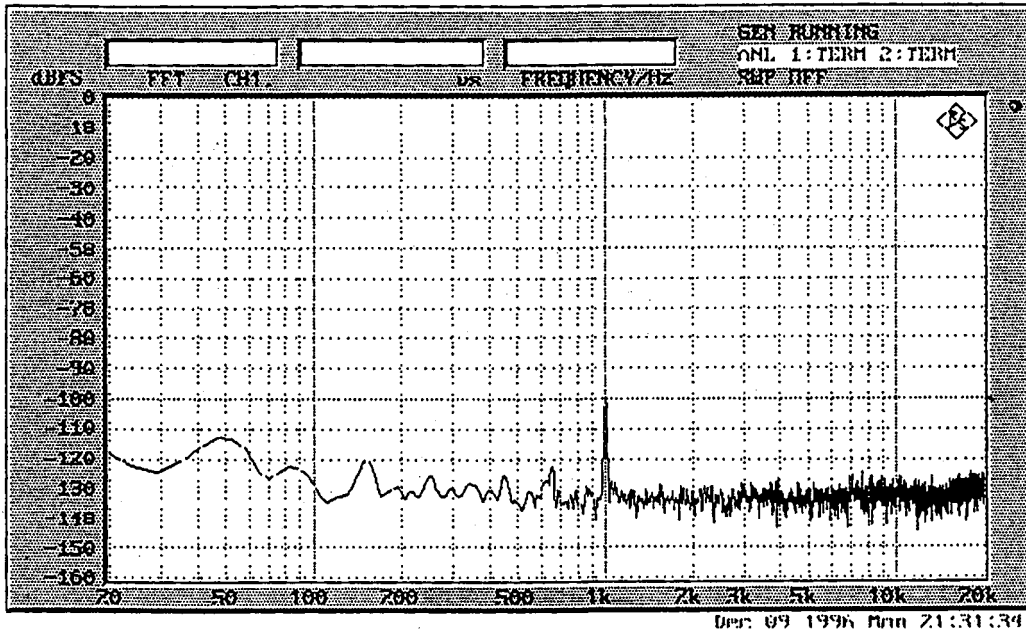

FFT plot

[Measurement Condition]

- Device: AK5352
- Measurement Unit: ROHDE&SCHWARZ,UPD04
- Power Supply: VA=VD=5.0V
- Sampling Frequency(fs): 48kHz
- MCLK: 256fs, BICK: 64fs, Slave mode
- Temperature: Room temperature
- Interface: DIT
- Points: 8192
- Averaging: 4
- Input Frequency: 1kHz
- Input Level: -100dB

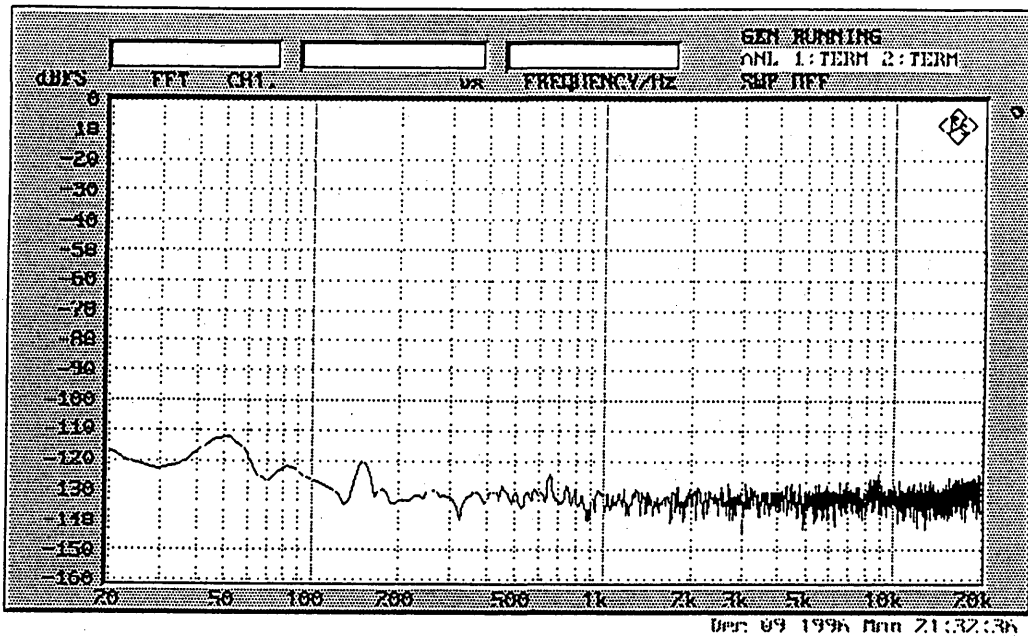

FFT plot

[Measurement Condition]

- Device: AK5352
- Measurement Unit: ROHDE&SCHWARZ,UPD04
- Power Supply: VA=VD=5.0V
- Sampling Frequency(fs): 48kHz
- MCLK: 256fs, BICK: 64fs, Slave mode
- Temperature: Room temperature
- Interface: DIT
- Points: 8192
- Averaging: 4
- Noise floor

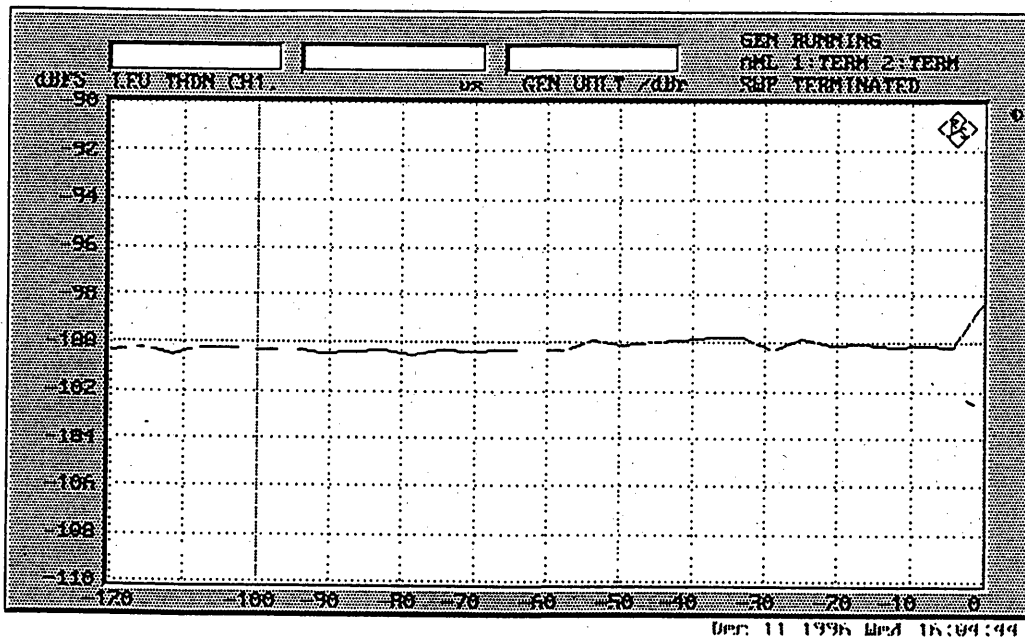

THD+N vs. Input Level

[Measurement Condition]

- Device: AK5352
- Measurement Unit: ROHDE&SCHWARZ,UPD04
- Power Supply: VA=VD=5.0V
- Sampling Frequency(fs): 48kHz
- MCLK: 256fs, BICK: 64fs, Slave mode
- Temperature: Room temperature
- Interface: DIT
- Bandwidth: 20 ~ 20kHz
- Input Frequency: 1kHz

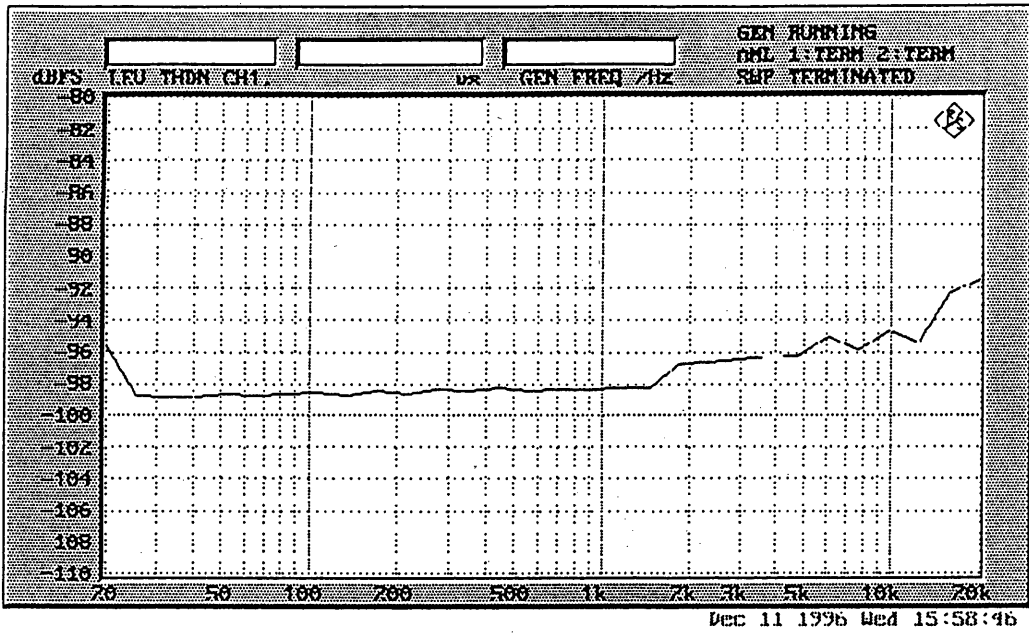

THD+N vs. Frequency

[Measurement Condition]

- Device: AK5352
- Measurement Unit: ROHDE&SCHWARZ,UPD04
- Power Supply: VA=VD=5.0V
- Sampling Frequency(fs): 48kHz
- MCLK: 256fs, BICK: 64fs, Slave mode
- Temperature: Room temperature
- Interface: DIT
- Bandwidth: 20 ~ 20kHz
- Input Level: -0.5dB

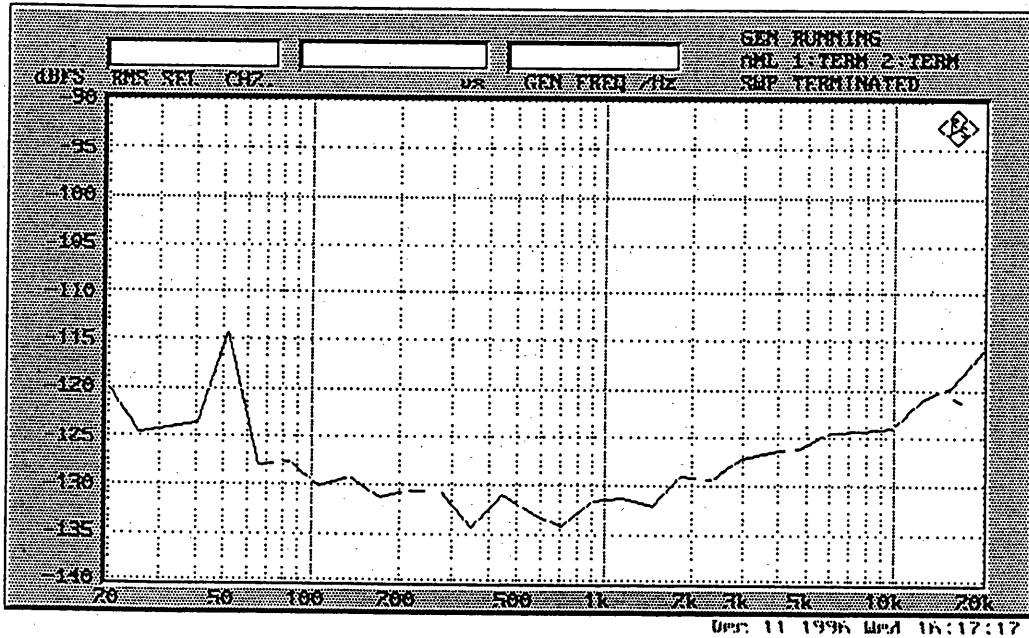

Crosstalk

[Measurement Condition]

- Device: AK5352
- Measurement Unit: ROHDE&SCHWARZ,UPD04
- Power Supply: VA=VD=5.0V
- Sampling Frequency(fs): 48kHz
- MCLK: 256fs, BICK: 64fs, Slave mode
- Temperature: Room temperature
- Interface: DIT
- Input Level: (Lch) -0.5dB  
(Rch) no input

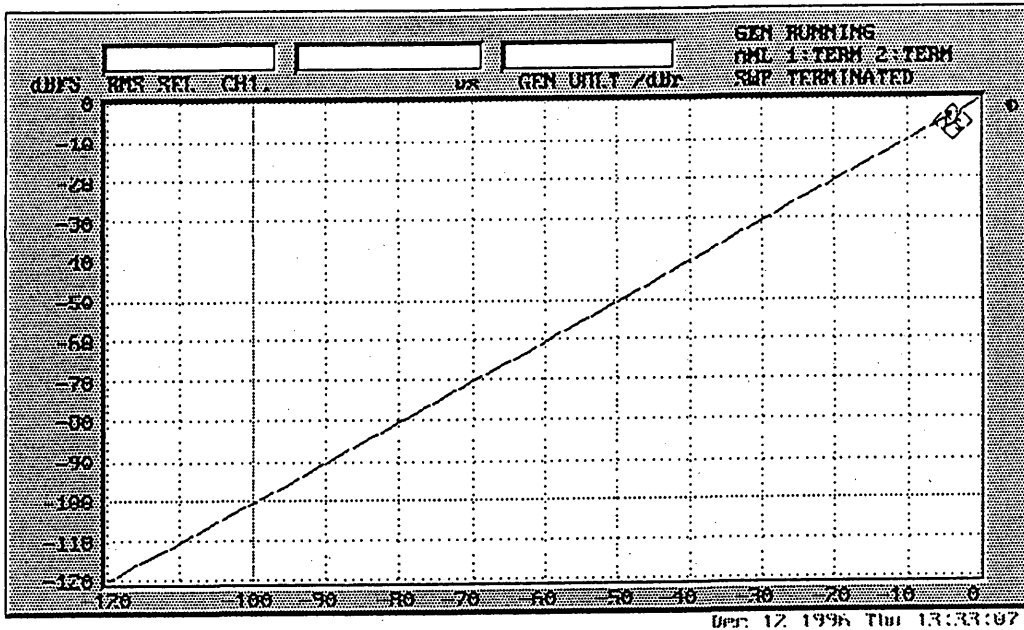

Linearity

[Measurement Condition]

- Device: AK5352
- Measurement Unit: ROHDE&SCHWARZ,UPD04
- Power Supply: VA=VD=5.0V
- Sampling Frequency(fs): 48kHz
- MCLK: 256fs, BICK: 64fs, Slave mode
- Temperature: Room temperature
- Interface: DIT
- Input Frequency: 1kHz

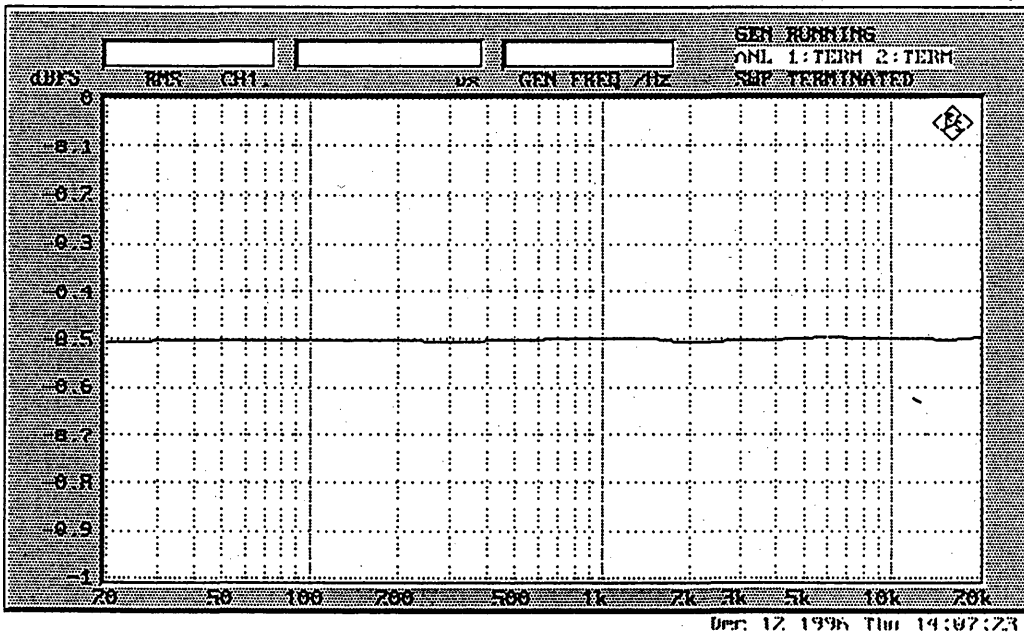

Frequency Response

[Measurement Condition]

- Device: AK5352
- Measurement Unit: ROHDE&SCHWARZ,UPD04
- Power Supply: VA=VD=5.0V
- Sampling Frequency(fs): 48kHz
- MCLK: 256fs, BICK: 64fs, Slave mode
- Temperature: Room temperature
- Interface: DIT
- Input Level: -0.5dB @ 1kHz
- AK5352 HPF off
- HPF on the board: fc=0.07Hz
- LPF on the board: none(C3, C21 none)



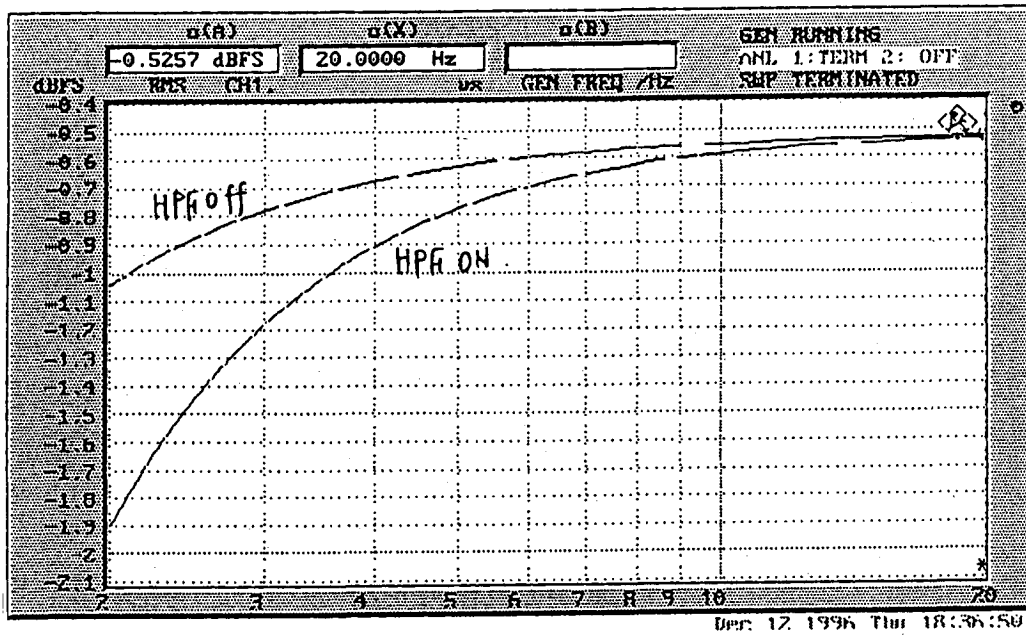

Frequency Response

[Measurement Condition]

- Device: AK5352
- Measurement Unit: ROHDE&SCHWARZ,UPD04
- Power Supply: VA=VD=5.0V
- Sampling Frequency(fs): 48kHz
- MCLK: 256fs, BICK: 64fs, Slave mode
- Temperature: Room temperature
- Interface: DIT
- Input Level: -0.5dB @ 1kHz
- HPF on the board: fc=0.07Hz
- LPF on the board: none(C3, C21 none)

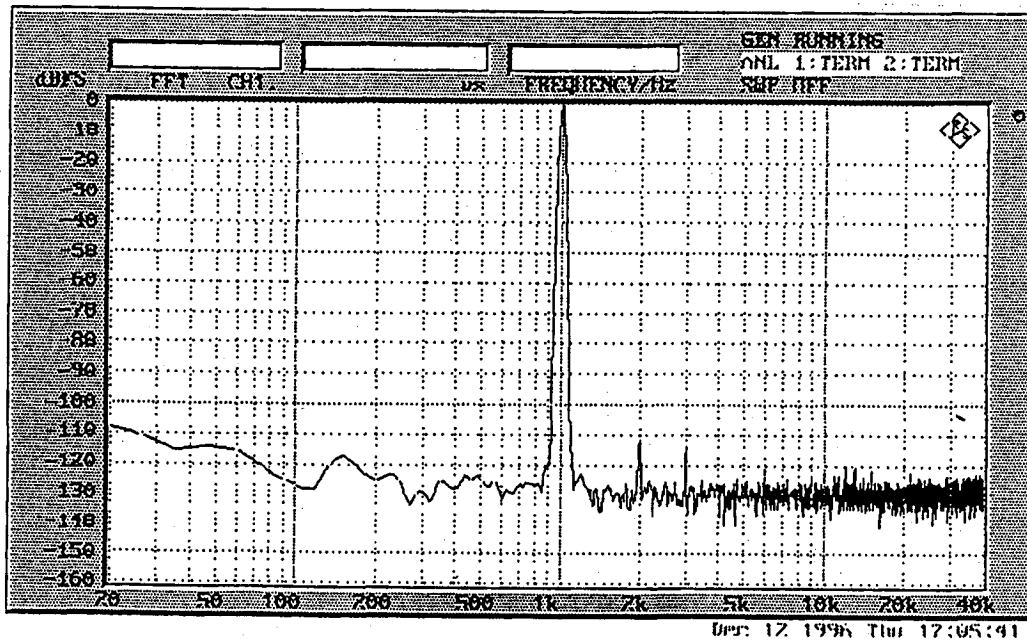

FFT plot

[Measurement Condition]

- Device: AK5352
- Measurement Unit: ROHDE&SCHWARZ,UPD04
- Power Supply: VA=VD=5.0V
- Sampling Frequency(fs): 96kHz
- MCLK: 256fs, BICK: 64fs, Slave mode
- Temperature: Room temperature
- Interface: 15pin D-sub
- Points: 8192
- Averaging: 4
- Input Frequency: 1kHz
- Input Level: -0.5dB

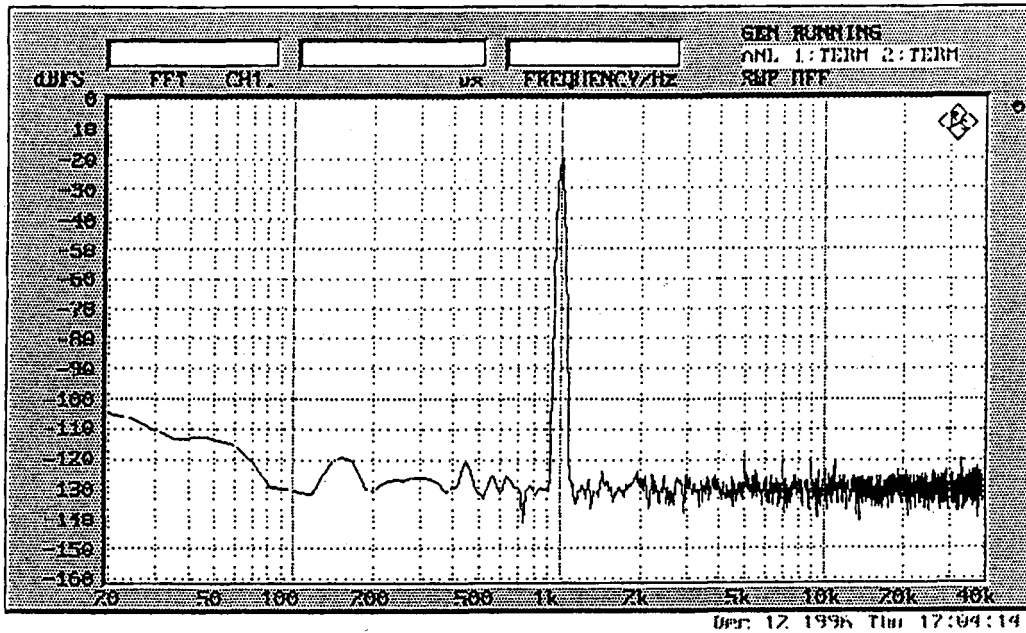

FFT plot

[Measurement Condition]

- Device: AK5352
- Measurement Unit: ROHDE&SCHWARZ,UPD04
- Power Supply: VA=VD=5.0V
- Sampling Frequency(fs): 96kHz
- MCLK: 256fs, BICK: 64fs, Slave mode
- Temperature: Room temperature
- Interface: 15pin D-sub
- Points: 8192
- Averaging: 4
- Input Frequency: 1kHz
- Input Level: -20dB

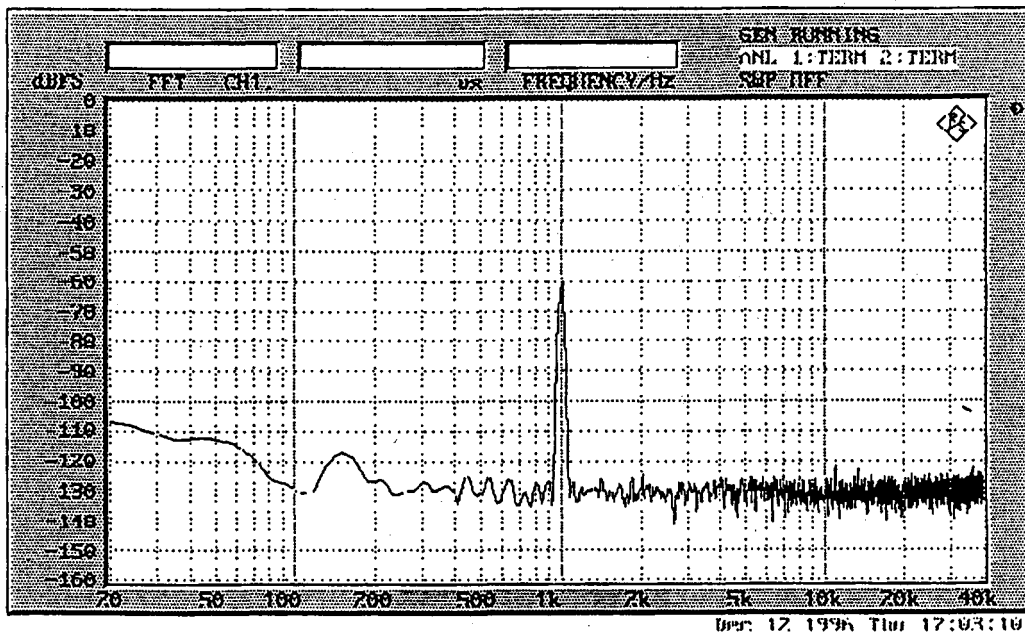

FFT plot

[Measurement Condition]

- Device: AK5352
- Measurement Unit: ROHDE&SCHWARZ,UPD04
- Power Supply: VA=VD=5.0V
- Sampling Frequency(fs): 96kHz
- MCLK: 256fs, BICK: 64fs, Slave mode
- Temperature: Room temperature
- Interface: 15pin D-sub
- Points: 8192
- Averaging: 4
- Input Frequency: 1kHz
- Input Level: -60dB

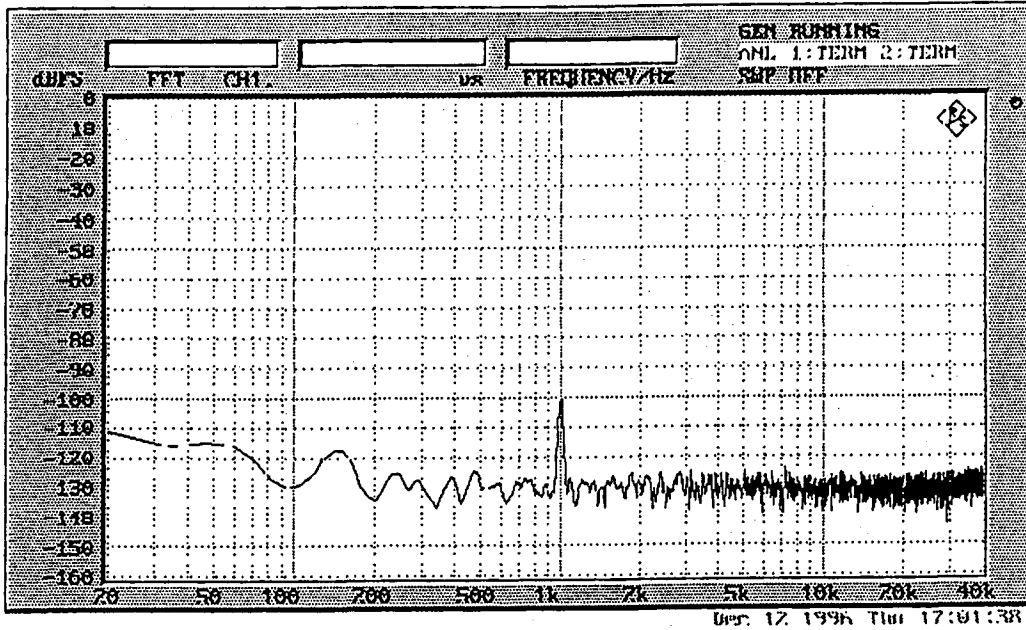

FFT plot

[Measurement Condition]

- Device: AK5352
- Measurement Unit: ROHDE&SCHWARZ,UPD04
- Power Supply: VA=VD=5.0V
- Sampling Frequency(fs): 96kHz
- MCLK: 256fs, BICK: 64fs, Slave mode
- Temperature: Room temperature
- Interface: 15pin D-sub
- Points: 8192
- Averaging: 4
- Input Frequency: 1kHz
- Input Level: -100dB

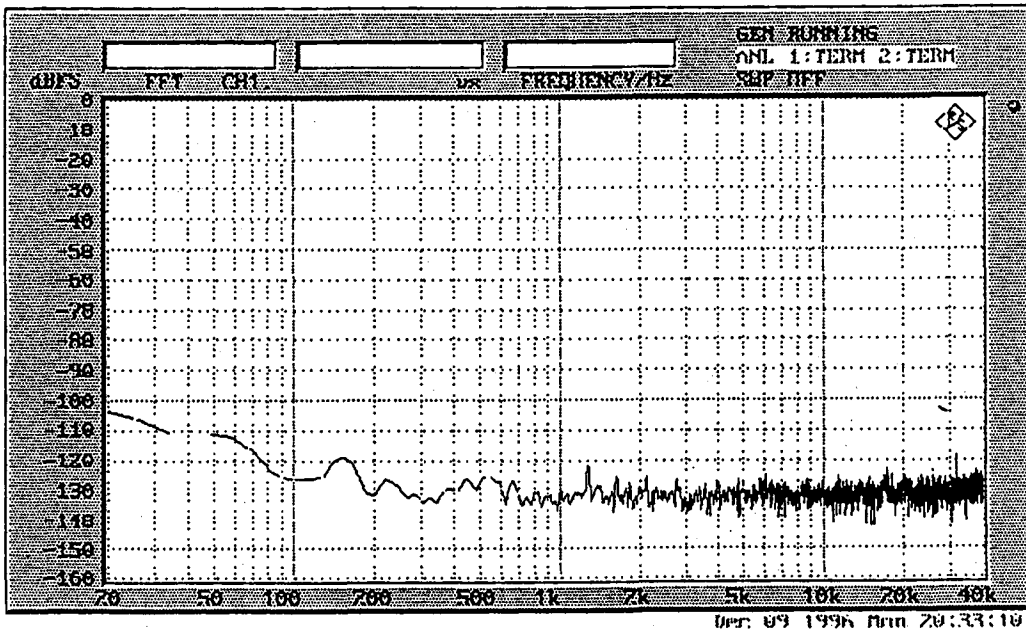

FFT plot

[Measurement Condition]

- Device: AK5352
- Measurement Unit: ROHDE&SCHWARZ,UPD04
- Power Supply: VA=VD=5.0V
- Sampling Frequency(fs): 96kHz
- MCLK: 256fs, BICK: 64fs, Slave mode
- Temperature: Room temperature
- Interface: 15pin D-sub
- Points: 8192
- Averaging: 4
- Noise floor

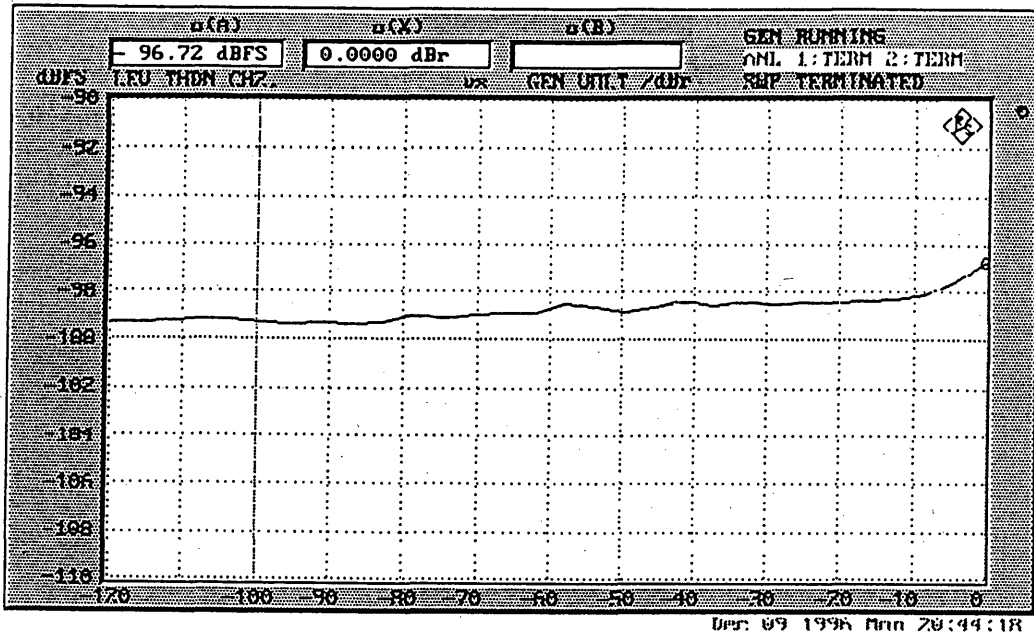

THD+N vs. Input Level

[Measurement Condition]

- Device: AK5352
- Measurement Unit: ROHDE&SCHWARZ,UPD04
- Power Supply: VA=VD=5.0V
- Sampling Frequency(fs): 96kHz
- MCLK: 256fs, BICK: 64fs, Slave mode
- Temperature: Room temperature
- Interface: 15pin D-sub
- Bandwidth: 20 ~ 40kHz
- Input Frequency: 1kHz

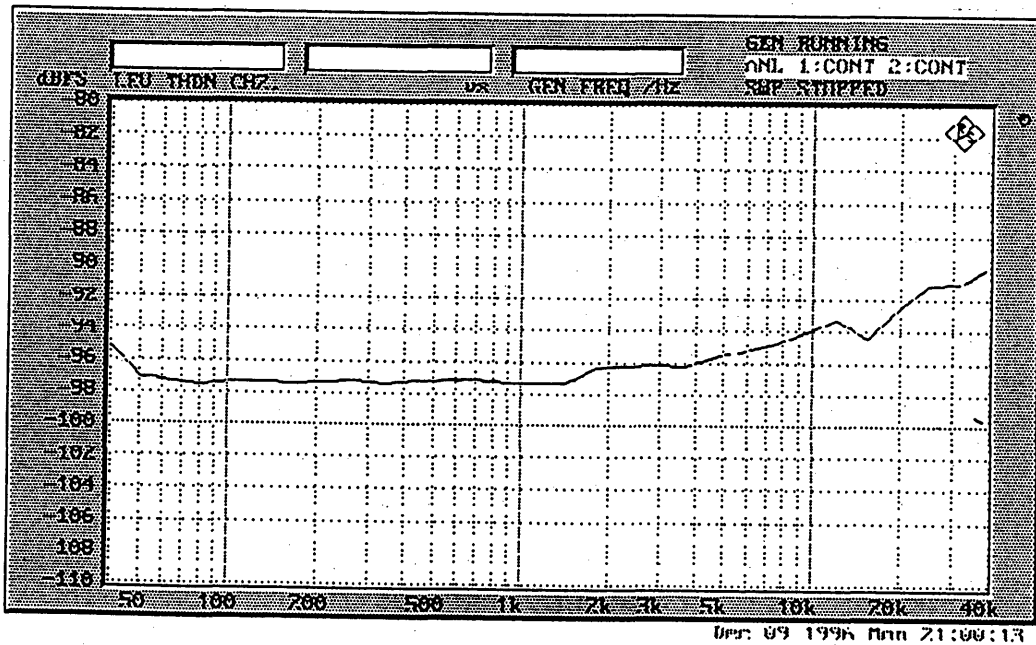

THD+N vs. Frequency

[Measurement Condition]

- Device: AK5352
- Measurement Unit: ROHDE&SCHWARZ,UPD04
- Power Supply: VA=VD=5.0V
- Sampling Frequency(fs): 96kHz
- MCLK: 256fs, BICK: 64fs, Slave mode
- Temperature: Room temperature
- Interface: 15pin D-sub
- Bandwidth: 20 ~ 40kHz
- Input Level: -0.5dB

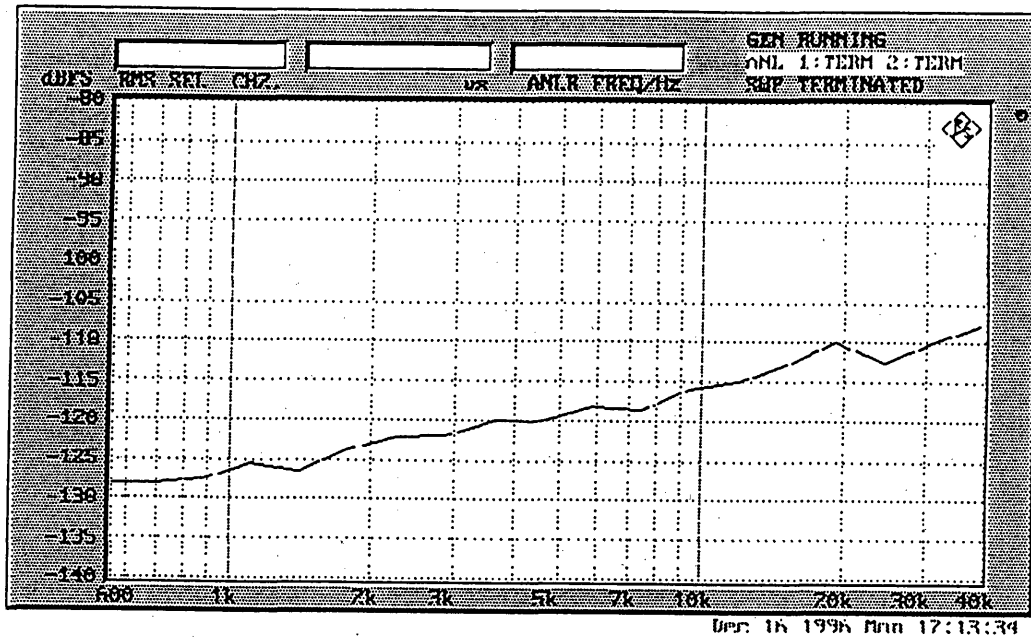

Crosstalk

[Measurement Condition]

- Device: AK5352
- Measurement Unit: ROHDE&SCHWARZ,UPD04
- Power Supply: VA=VD=5.0V
- Sampling Frequency(fs): 96kHz
- MCLK: 256fs, BICK: 64fs, Slave mode
- Temperature: Room temperature
- Interface: 15pin D-sub
- Input Level: (Lch) -0.5dB  
(Rch) no input

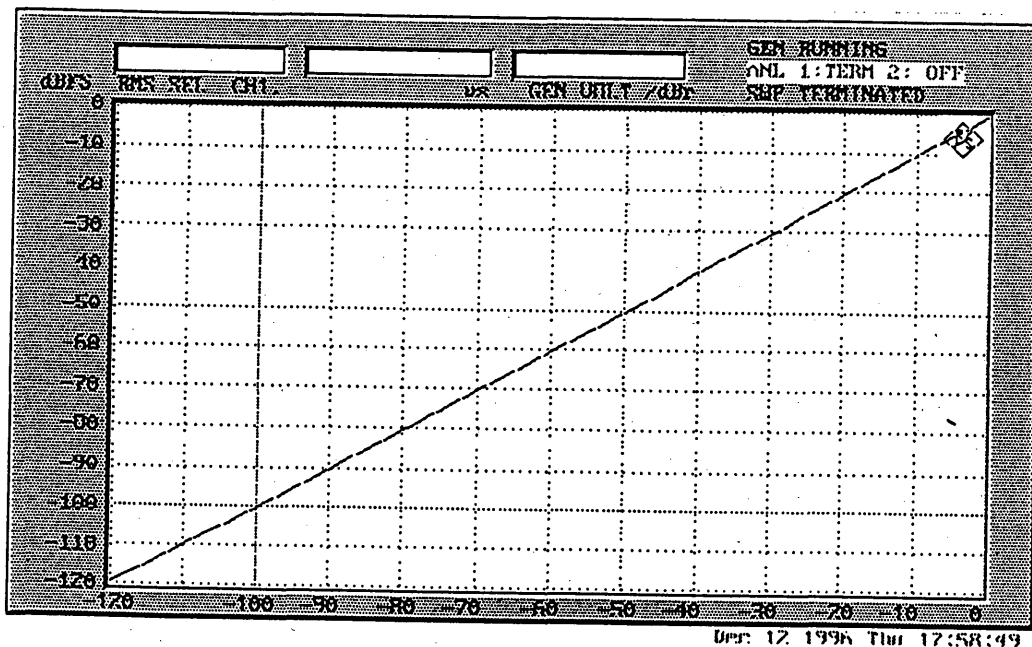

Linearity

[Measurement Condition]

- Device: AK5352
- Measurement Unit: ROHDE&SCHWARZ,UPD04
- Power Supply: VA=VD=5.0V
- Sampling Frequency(fs): 96kHz
- MCLK: 256fs, BICK: 64fs, Slave mode
- Temperature: Room temperature
- Interface: 15pin D-sub
- Input Frequency: 1kHz

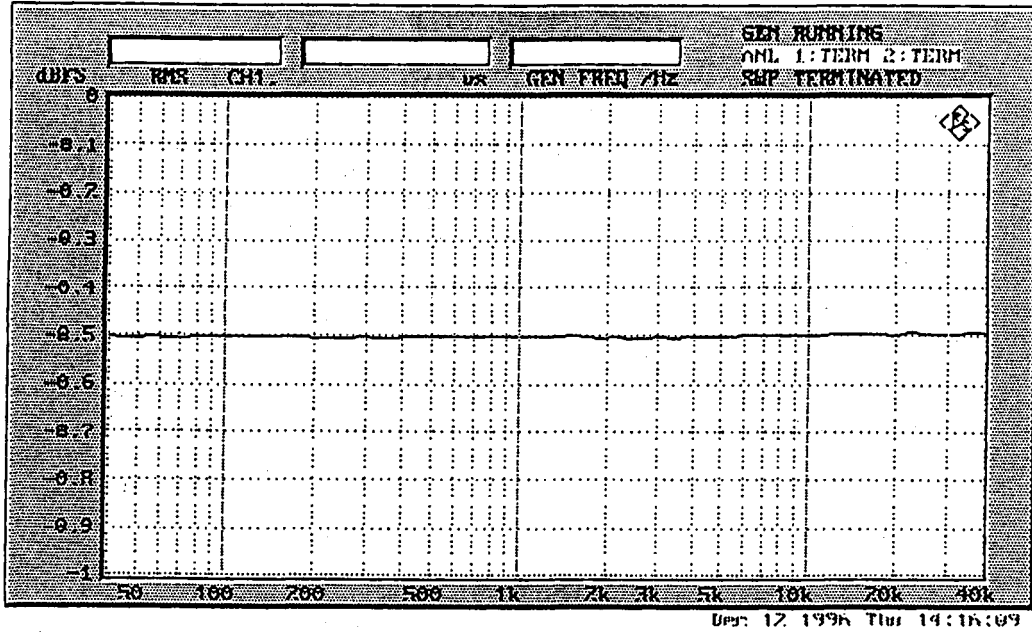

Frequency Response

[Measurement Condition]

- Device: AK5352
- Measurement Unit: ROHDE&SCHWARZ,UPD04
- Power Supply: VA=VD=5.0V
- Sampling Frequency(fs): 96kHz
- MCLK: 256fs, BICK: 64fs, Slave mode
- Temperature: Room temperature
- Interface: 15pin D-sub
- Input Level: -0.5dB @ 1kHz
- AK5352 HPF off
- HPF on the board: fc=0.07Hz
- LPF on the board: none(C3,C21 none)

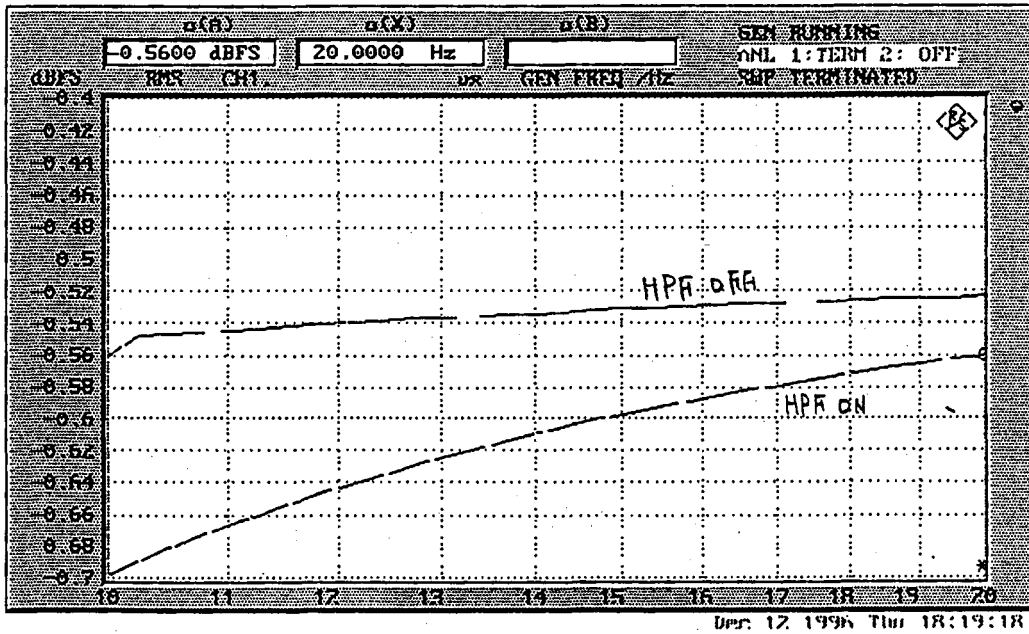

Frequency Response

[Measurement Condition]

- Device: AK5352
- Measurement Unit: ROHDE&SCHWARZ,UPD04
- Power Supply: VA=VD=5.0V
- Sampling Frequency(fs): 96kHz
- MCLK: 256fs, BICK: 64fs, Slave mode
- Temperature: Room temperature
- Interface: 15pin D-sub
- Input Level: -0.5dB @ 1kHz
- HPF on the board: fc=0.7Hz
- LPF on the board: none(C3,C21 none)

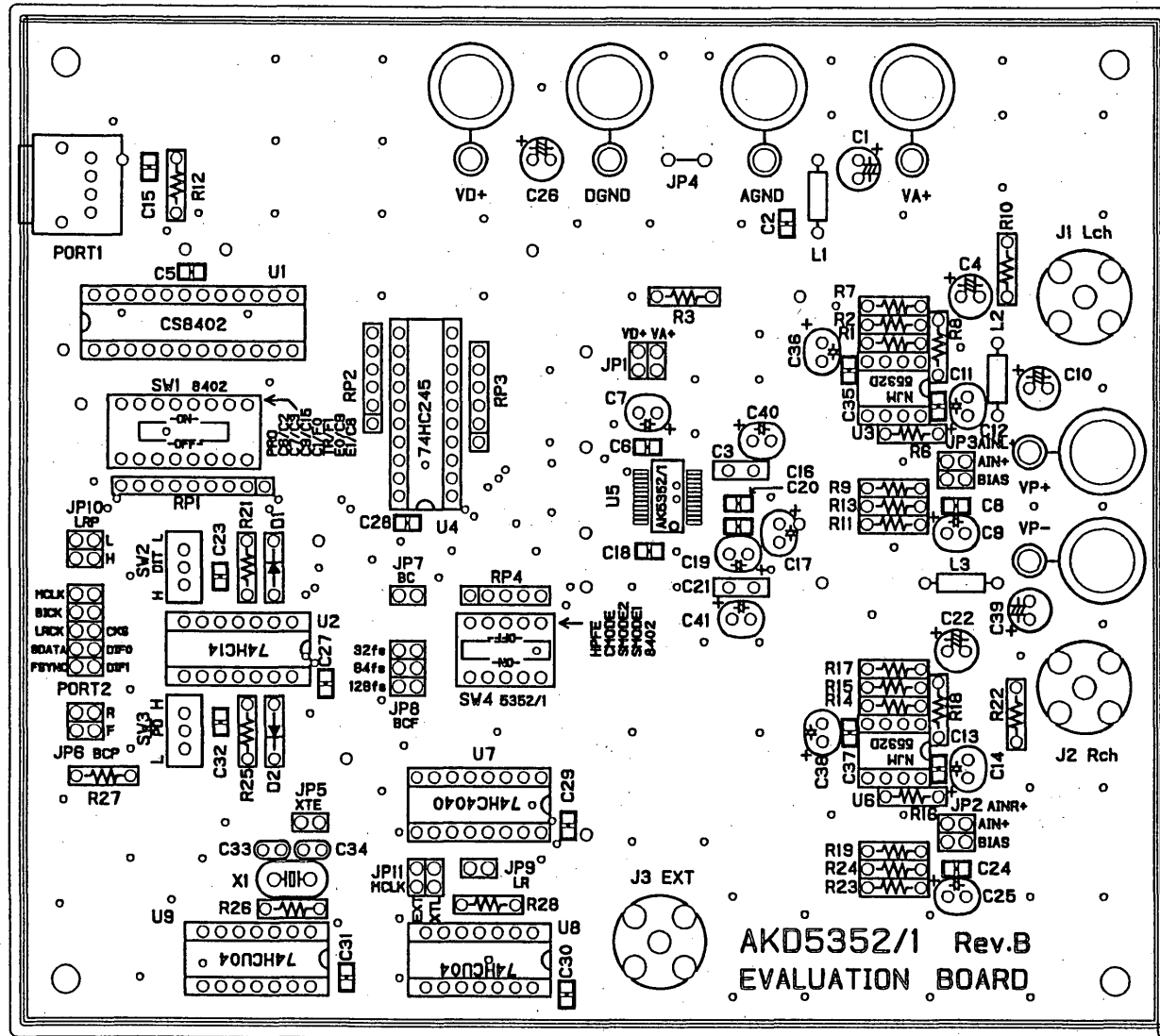

AKD5352/1 Rev.B L1 L3RSILK

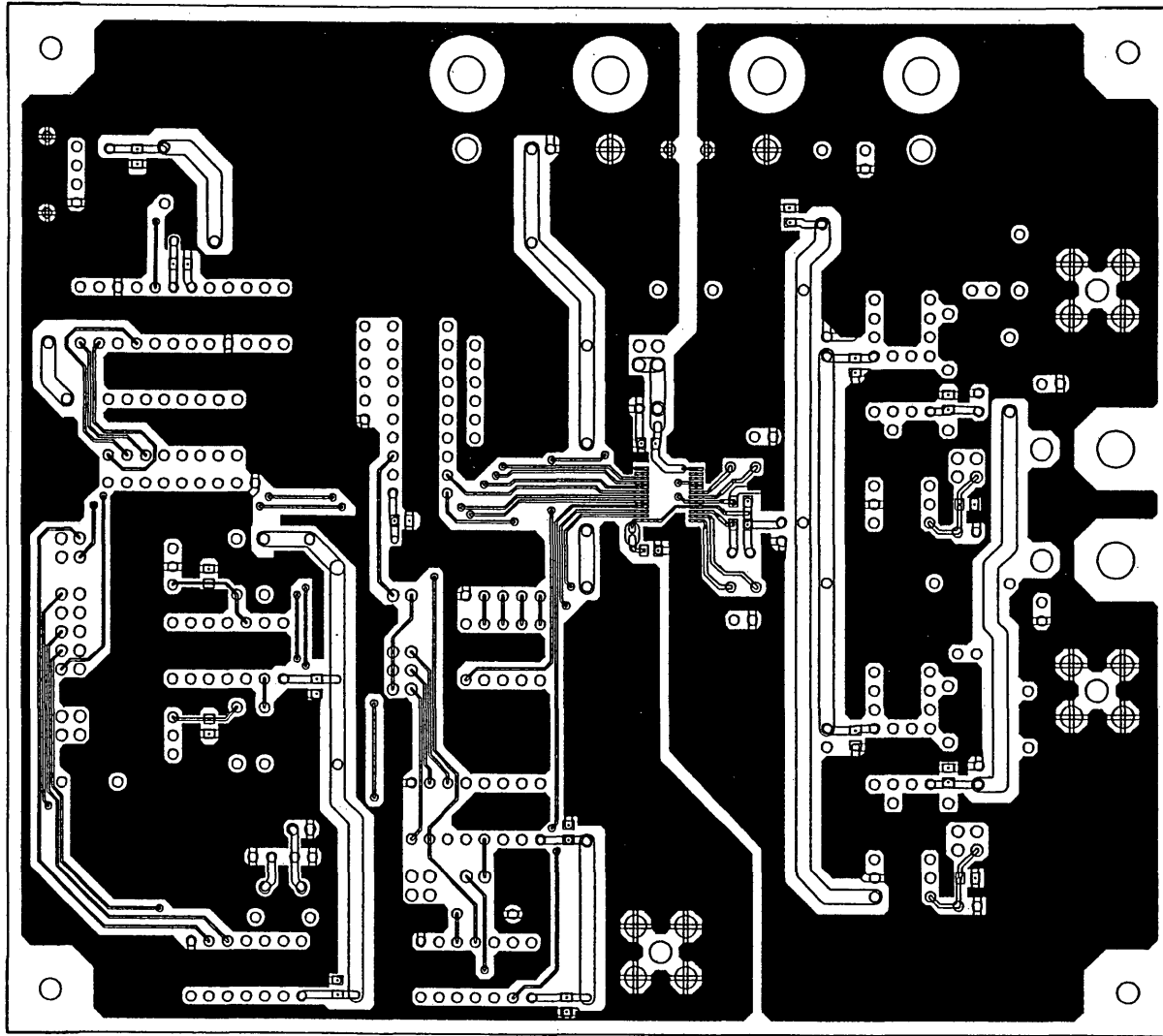

AKD5352/1 Rev.B LI



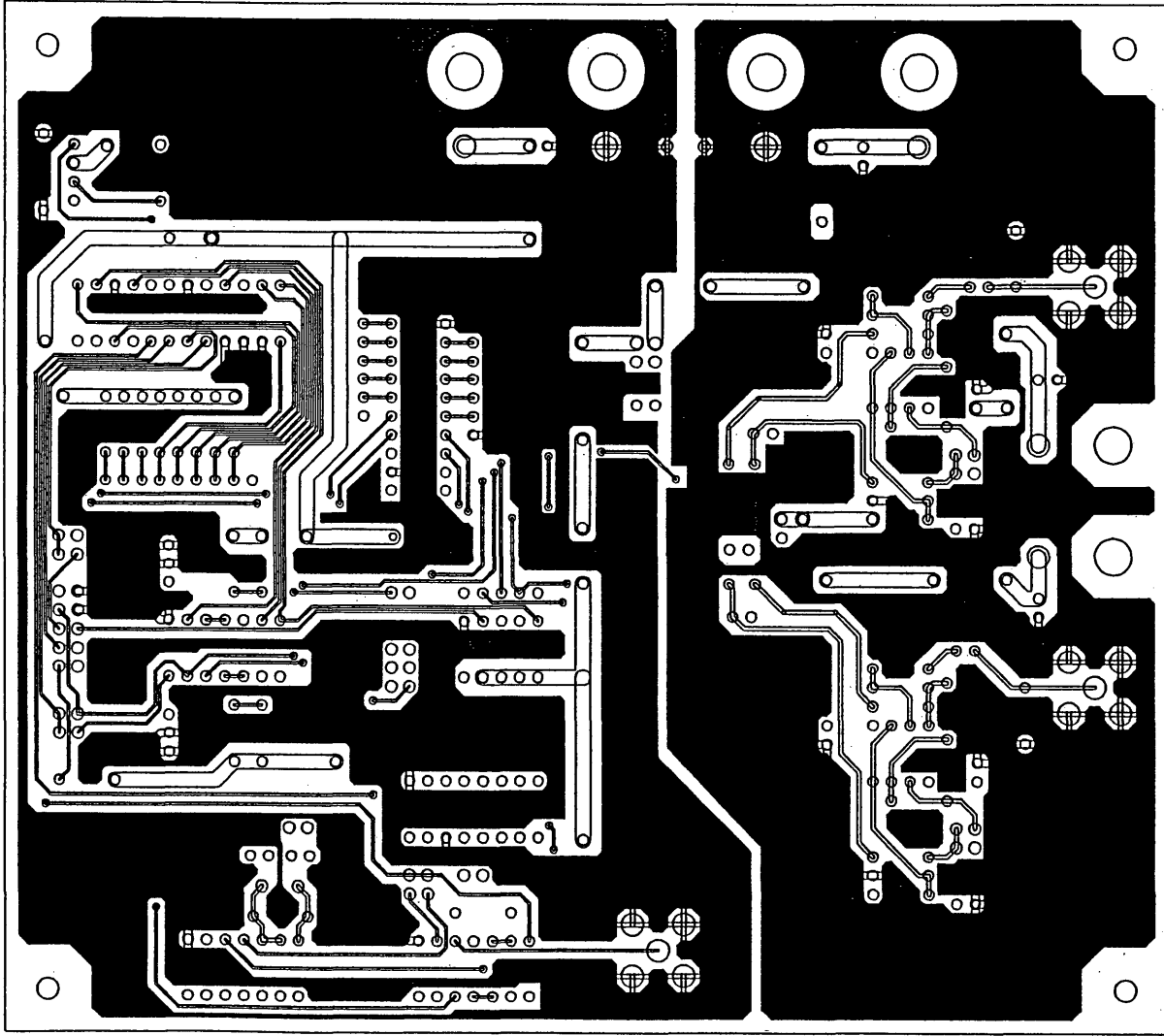

AKD23251 Rev.B LS

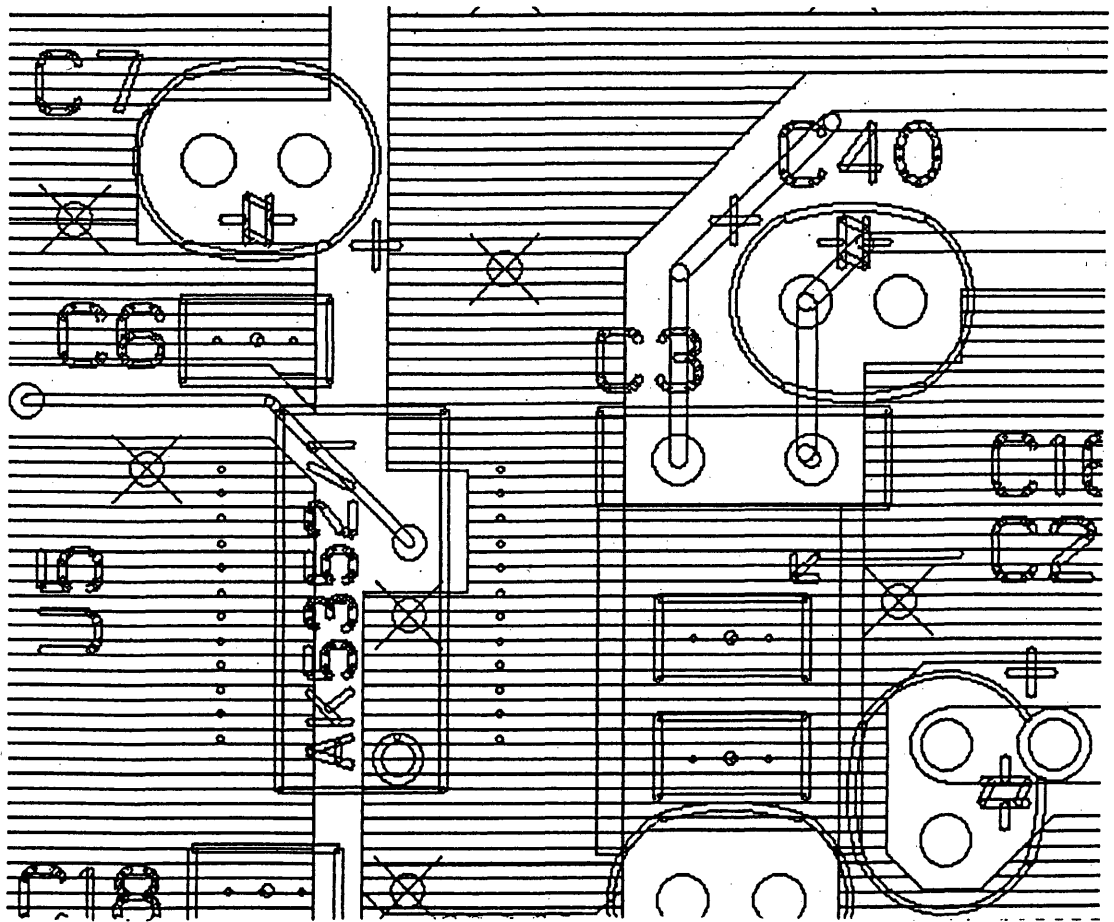
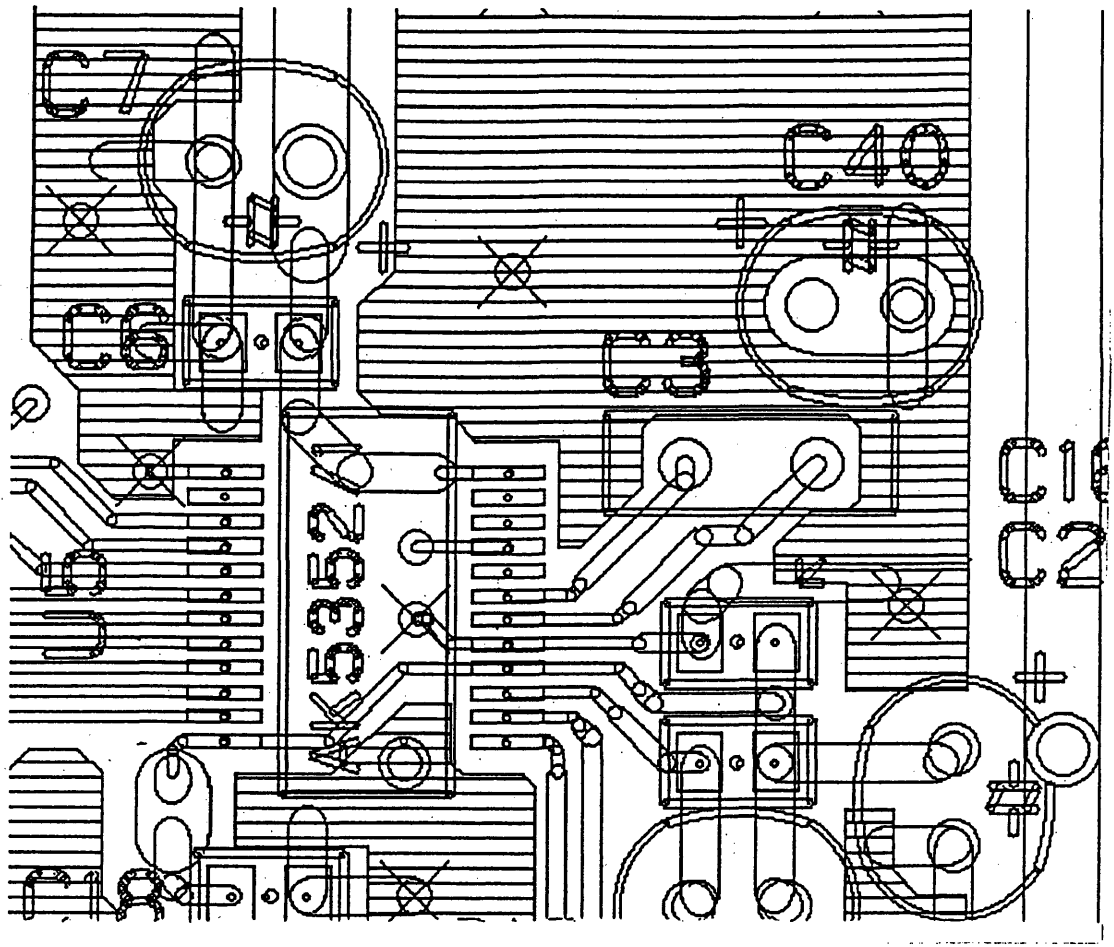

## IMPORTANT NOTICE

- These products and their specifications are subject to change without notice. Before considering any use or application, consult the Asahi Kasei Microsystems Co., Ltd. (AKM) sales office or authorized distributor concerning their current status.
- AKM assumes no liability for infringement of any patent, intellectual property, or other right in the application or use of any information contained herein.
- Any export of these products, or devices or systems containing them, may require an export license or other official approval under the law and regulations of the country of export pertaining to customs and tariffs, currency exchange, or strategic materials.
- AKM products are neither intended nor authorized for use as critical components in any safety, life support, or other hazard related device or system, and AKM assumes no responsibility relating to any such use, except with the express written consent of the Representative Director of AKM. As used here:
  - (a) A hazard related device or system is one designed or intended for life support or maintenance of safety or for applications in medicine, aerospace, nuclear energy, or other fields, in which its failure to function or perform may reasonably be expected to result in loss of life or in significant injury or damage to person or property.
  - (b) A critical component is one whose failure to function or perform may reasonably be expected to result, whether directly or indirectly, in the loss of the safety or effectiveness of the device or system containing it, and which must therefore meet very high standards of performance and reliability.
- It is the responsibility of the buyer or distributor of an AKM product who distributes, disposes of, or otherwise places the product with a third party to notify that party in advance of the above content and conditions, and the buyer or distributor agrees to assume any and all responsibility and liability for and hold AKM harmless from any and all claims arising from the use of said product in the absence of such notification.