

	<h1 style="margin: 0;">AKD5359-B</h1> <h2 style="margin: 0;">AK5359 Evaluation Board Rev.0</h2>
---	---

GENERAL DESCRIPTION

AKD5359-B is an evaluation board for the digital audio 24bit 96kHz A/D converter, AK5359. AKD5359-B has analog input circuits and a digital interface transmitter, and can achieve the interface with digital audio systems via opt-connector.

■ **Ordering guide**

AKD5359-B --- AK5359 Evaluation Board

FUNCTION

- **DIT (AK4114) with optical output**

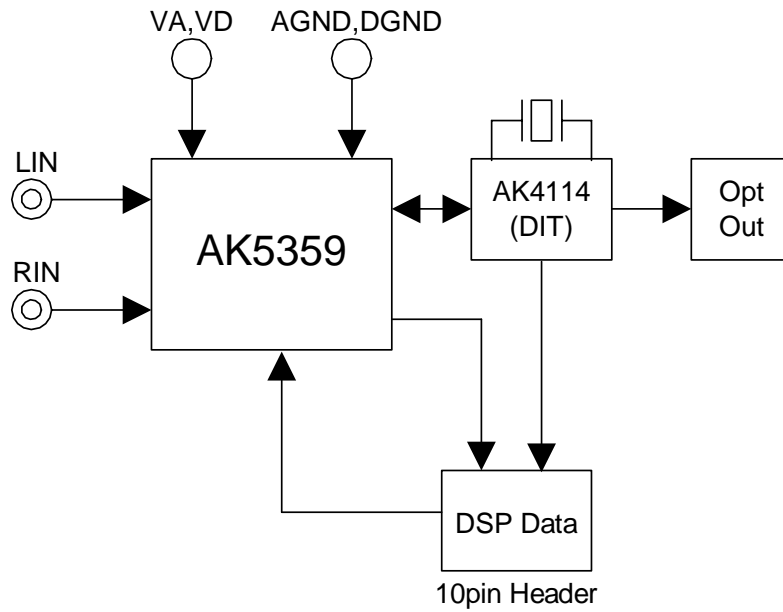

Figure 1 AKD5359-B Block Diagram

* Circuit diagram and PCB layout are attached at the end of this manual.

1. Evaluation Board Manual

■ Operation sequence

1) Set up the power supply lines.

[VA]	(red)	= 2.7 ~ 5.5V or +15V	: for VA of AK5359 (typ. 5.0V)
[VD]	(orange)	= 2.7 ~ 5.5V	: for VD of AK5359, 74HC14 (typ. 5.0V)
[VCC]	(red)	= 3.3V	: for AK4114
[AGND]	(black)	= 0V	: for analog ground
[DGND]	(black)	= 0V	: for logic ground

Each supply line should be distributed from the power supply unit.

2) Set up the evaluation mode, jumper pins and DIP switches. (See the followings.)

3) Power on.

The AK5359 and AK4114 should be reset once bringing SW2 = "L" upon power-up.

■ Evaluation mode

(1) Slave Mode

(1-1) A/D evaluation using DIT function of AK4114

PORT2 (DIT) is used. DIT generates audio bi-phase signal from received data and which is output through optical connector (TOTX141). It is possible to connect AKM's D/A converter evaluation boards on the digital-amplifier, which equips DIR input. Nothing should be connected to PORT1 (DSP).

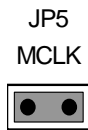

(1-2) All interface signals including master clock are fed externally.

PORT1 (DSP) is used. All interface signals (MCLK, SCLK, LRCK) are provided to the AK5359 through PORT1. JP5 (MCLK) should be open. The DIF1 of SW1 (MODE) should be set to "H".

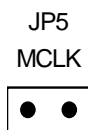

(2) Master Mode

(2-1) A/D evaluation using DIT function of AK4114

PORT2 (DIT) is used. DIT generates audio bi-phase signal from received data and which is output through optical connector (TOTX141). It is possible to connect AKM's D/A converter evaluation boards on the digital-amplifier, which equips DIR input. Nothing should be connected to PORT1 (DSP). The DIF1 of SW1 (MODE) should be set to "H".

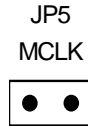

(2-2) Master clock is fed externally.

PORT1 (DSP) is used. MCLK is provided to the AK5359 through PORT1. JP5 (MCLK) should be open. The DIF1 of SW1 (MODE) should be set to "H".

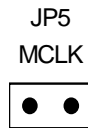

■ Other jumper pins set up

1. JP1 (GND) : Analog ground and Digital ground
 OPEN : Separated.
 SHORT: Common. (The connector "DGND" can be open.) <Default>
2. JP2 (CKS1) : Setting of CKS1 pin for AK5359
 H : Master mode
 L : Slave mode <Default>
3. JP3 (VA) : Select VA for AK5359
 VA : Supply from VA connector
 REG : Supply from regulator. VA connector should be supplied +15V. <Default>
4. JP4 (VD) : Select VD for AK5359
 VA : Supply from VA connector
 VD : Supply from VD connector <Default>

■ DIP Switch set up

[SW1] (MODE1): Setting the evaluation mode for AK5359 and AK4114
ON is “H”, OFF is “L”. CKS1 should be set by JP2.

No.	Name	OFF (“L”)	ON (“H”)
1	CKS0	See Table 2	
2	CKS2		
3	DIF	MSB justified	I ² S Compatible
4	DIF1	AK4114 Master mode	AK4114 Slave mode

Table 1. Mode Setting

CKS2	CKS1	CKS0	HPF	Master/Slave	MCLK	SCLK
L	L	L	ON	Slave	128/192fs (108k<fs≤216k) 256/384fs (8k≤fs≤108k) 512/768fs (8k≤fs≤54k)	≥ 48fs or 32fs
L	L	H	OFF	Slave	128/192fs (108k<fs≤216k) 256/384fs (8k≤fs≤108k) 512/768fs (8k≤fs≤54k)	≥ 48fs or 32fs
L	H	L	ON	Master	256fs (8k≤fs≤108k)	64fs
L	H	H	ON	Master	512fs (8k≤fs≤54k)	64fs
H	L	L	ON	Master	128fs (108k<fs≤216k)	64fs
H	L	H	ON	Master	192fs (108k<fs≤216k)	64fs
H	H	L	ON	Master	384fs (8k≤fs≤108k)	64fs
H	H	H	ON	Master	768fs (8k≤fs≤54k)	64fs

Table 2. Mode Setting of AK5359

Note: AK4114 does not support MCLK=384fs/512fs/768fs.
PORT1 (DSP) should be used when MCLK=384fs/512fs/768fs.

■ The function of the toggle SW

Upper-side is “H” and lower-side is “L”.

[SW2] (PDN): Resets the AK5359 and AK4114. Keep “H” during normal operation.

■ Analog Input Circuits

Analog signal is input via J1(RIN) and J2(LIN) of RCA connectors.

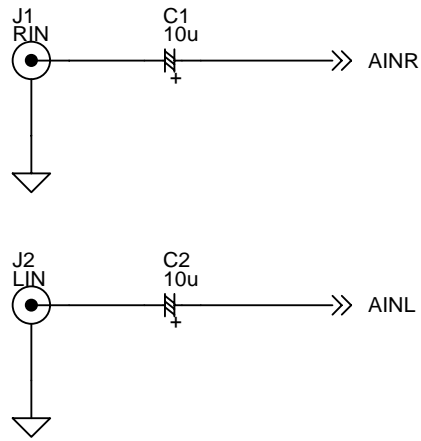

Figure 2 Analog Input circuits

* AKM assumes no responsibility for the trouble when using the circuit examples.

MEASUREMENT RESULTS

[Measurement condition]

- Measurement unit : Audio Precision, System Two Cascade
- MCLK : 256fs, 128fs
- SCLK : 64fs
- fs : 48kHz, 96kHz, 192kHz
- Bit : 24bit
- Power Supply : VA = VD = 5.0V (Using regulator)
- Interface : DIT
- Temperature : Room

Parameter		Result (Lch / Rch)	Unit
ADC Analog Input Characteristics:			
S/(N+D) (-1dB Input)	fs=48kHz	94.9 / 94.0	dB
	fs=96kHz	94.5 / 93.5	dB
	fs=192kHz	93.5 / 92.4	dB
D-Range (-60dB Input)	fs=48kHz, A-weighted	102.2 / 102.2	dB
	fs=96kHz	98.6 / 98.6	dB
	fs=192kHz	98.5 / 98.5	dB
S/N	fs=48kHz, A-weighted	102.7 / 102.7	dB
	fs=96kHz	98.7 / 98.7	dB
	fs=192kHz	98.7 / 98.7	dB

fs=48kHz

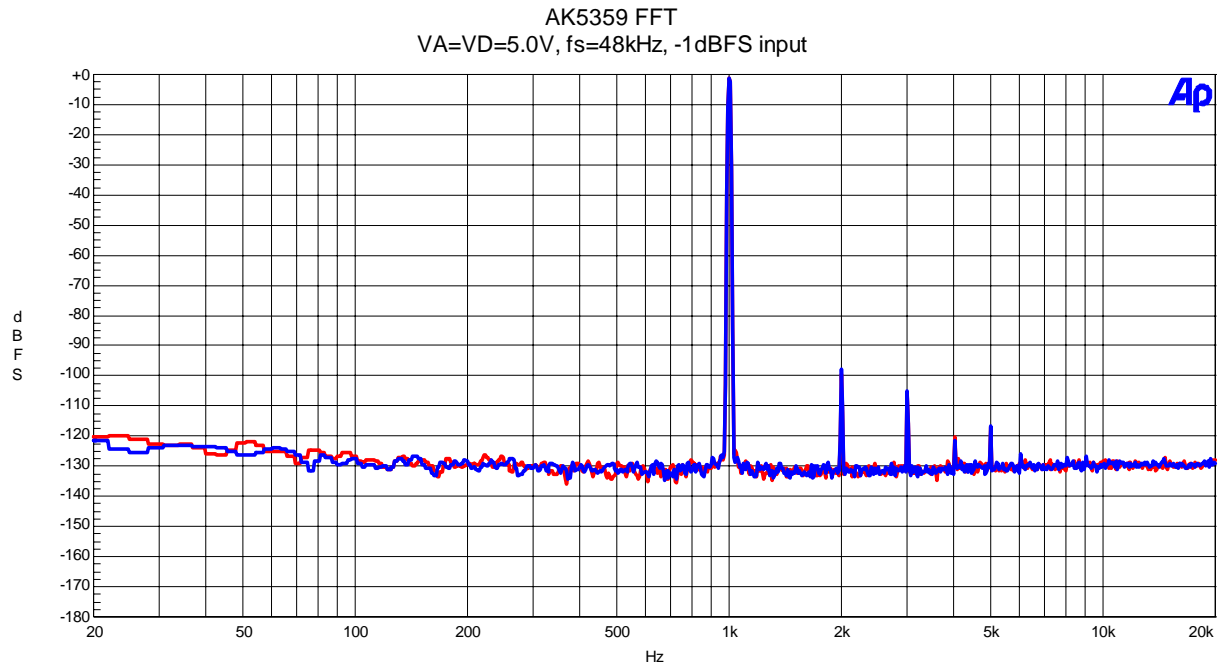

Figure 3 FFT (1kHz, -1dB input)

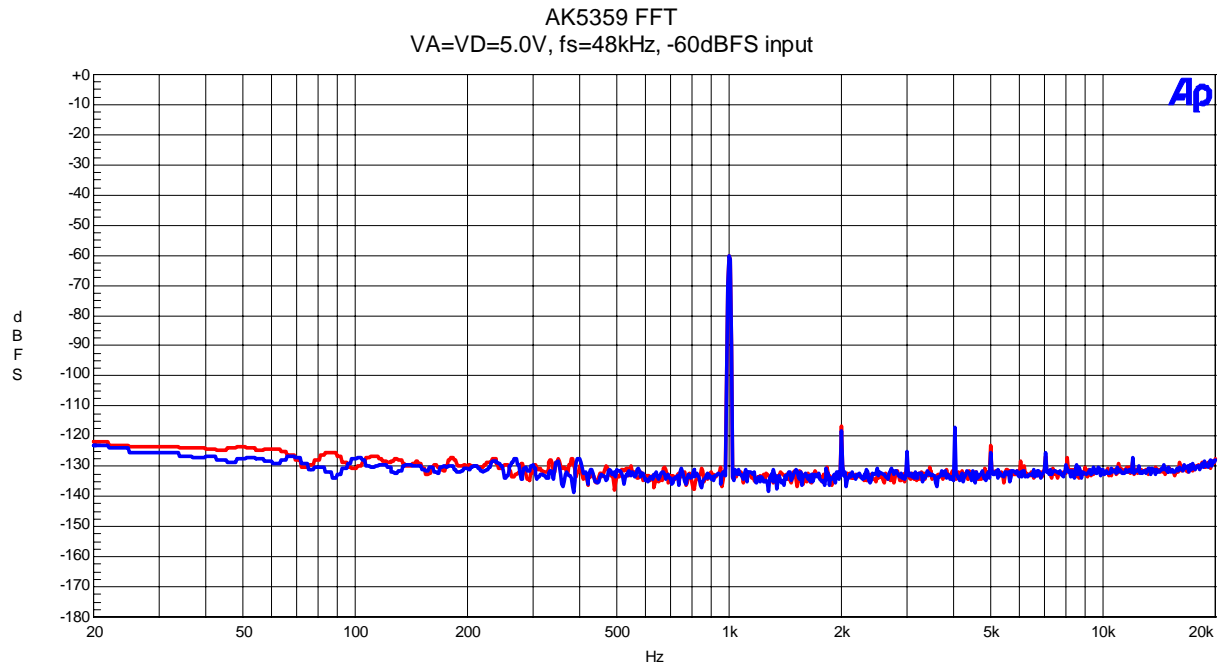

Figure 4 FFT (1kHz, -60dB input)

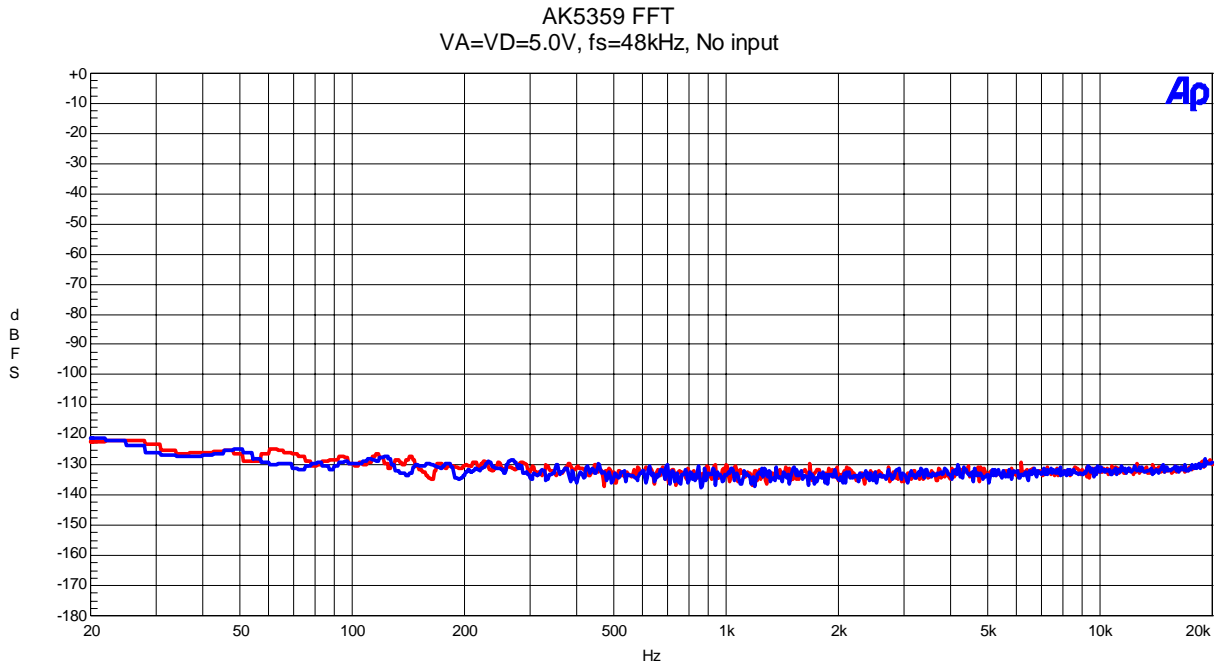

Figure 5 FFT (off the input)

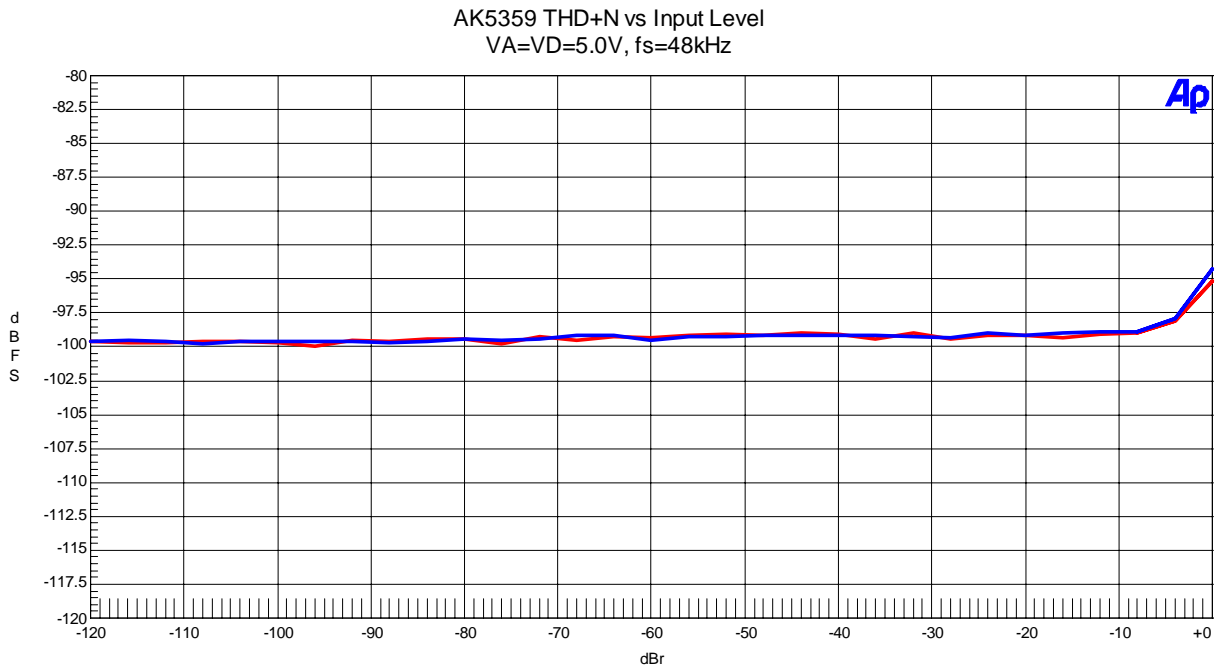

Figure 6 THD+N vs Input Level (1kHz input)

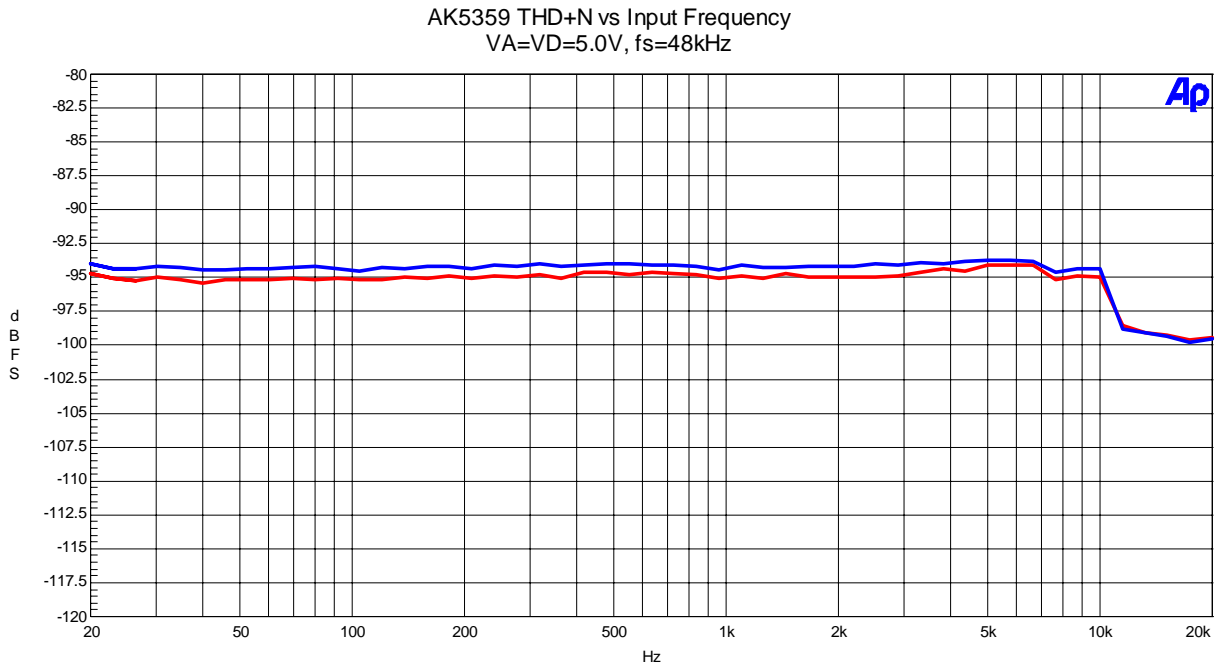

Figure 7 THD+N vs Input Frequency (1kHz input)

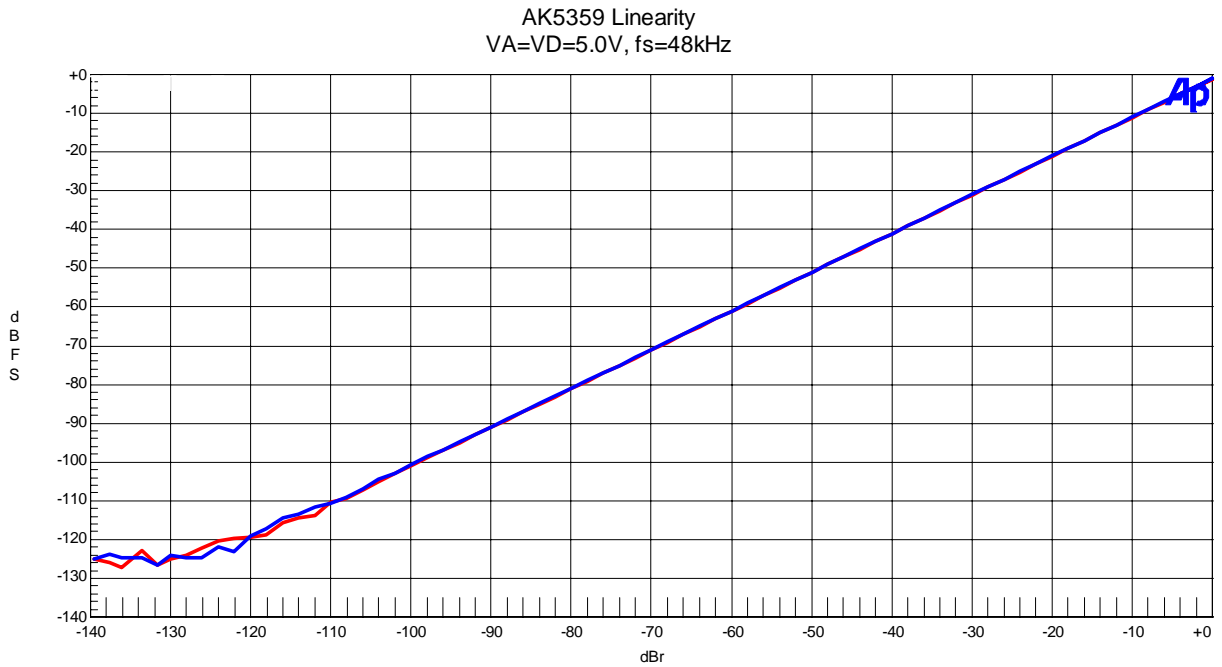

Figure 8 Linearity (fin=1kHz)

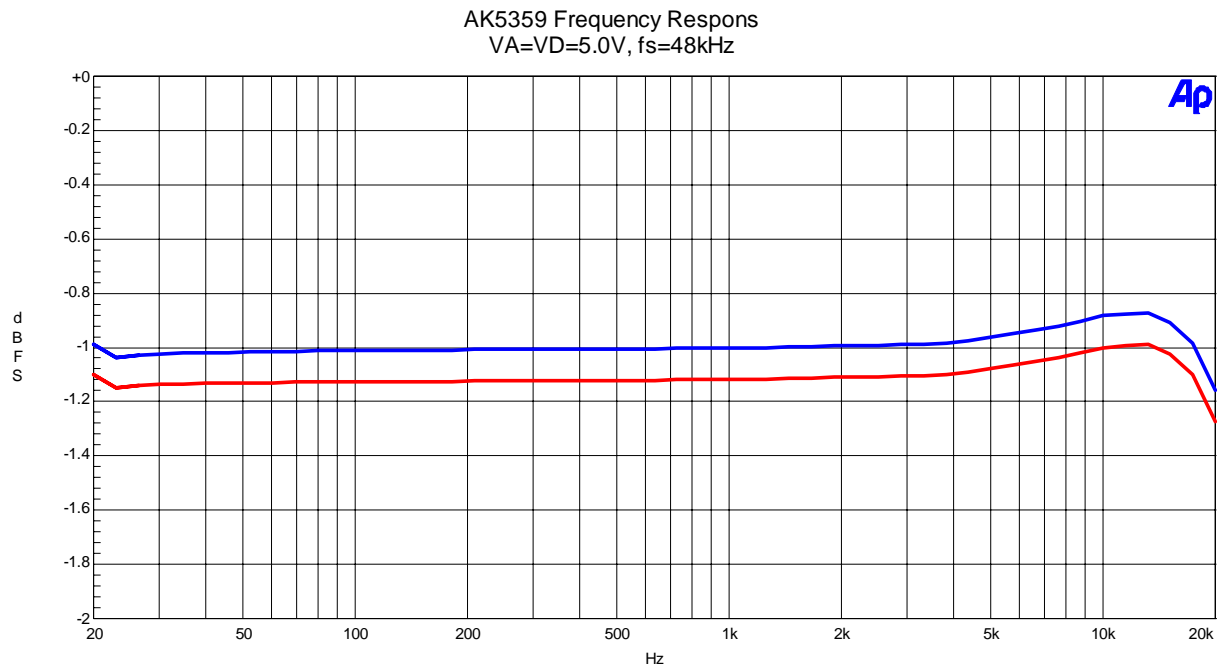

Figure 9 Frequency Response (-1dB input)

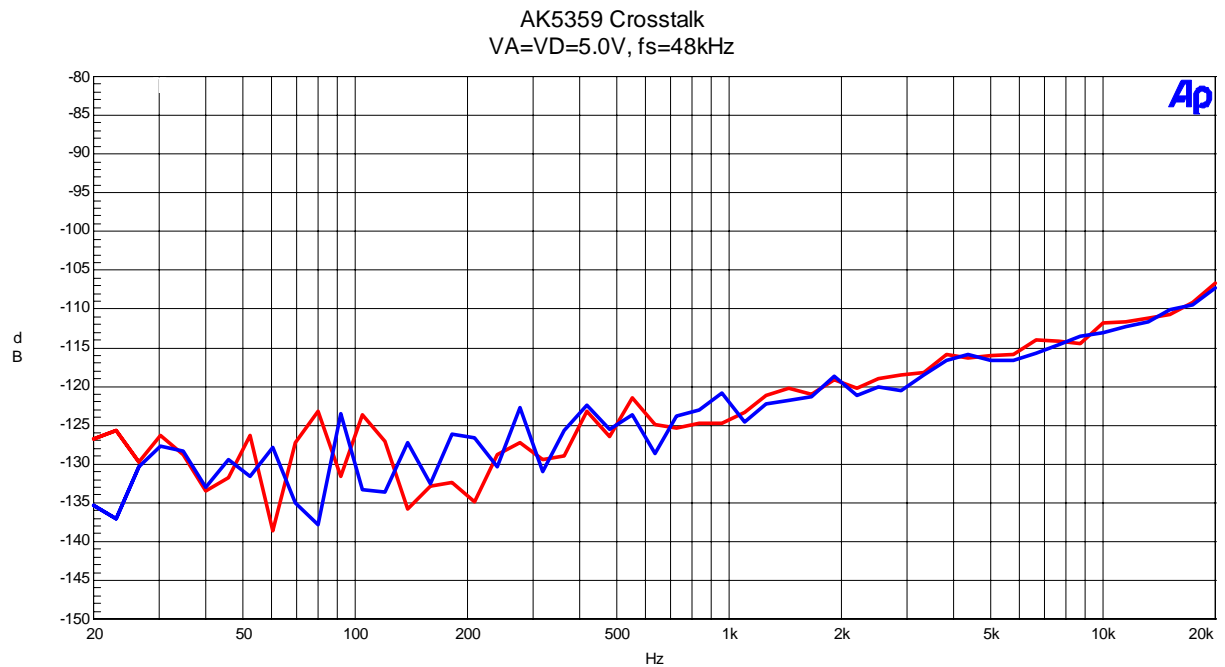

Figure 10 Cross-talk (-1dB input)

fs=96kHz

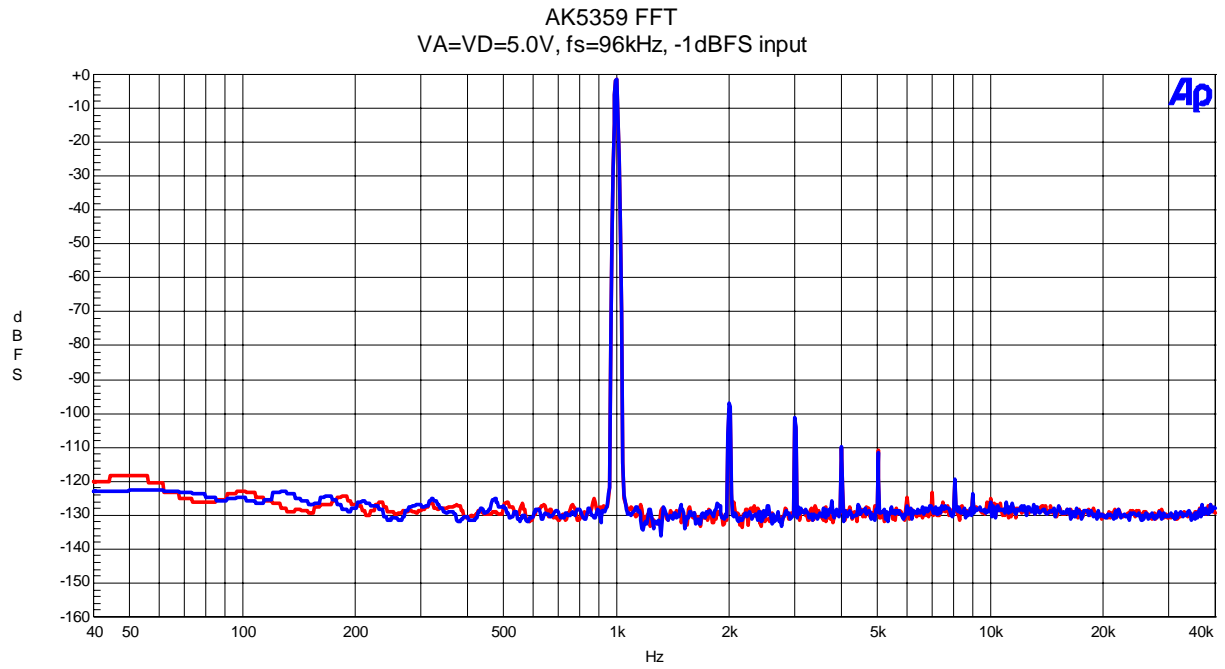

Figure 11 FFT (1kHz, -1dB input)

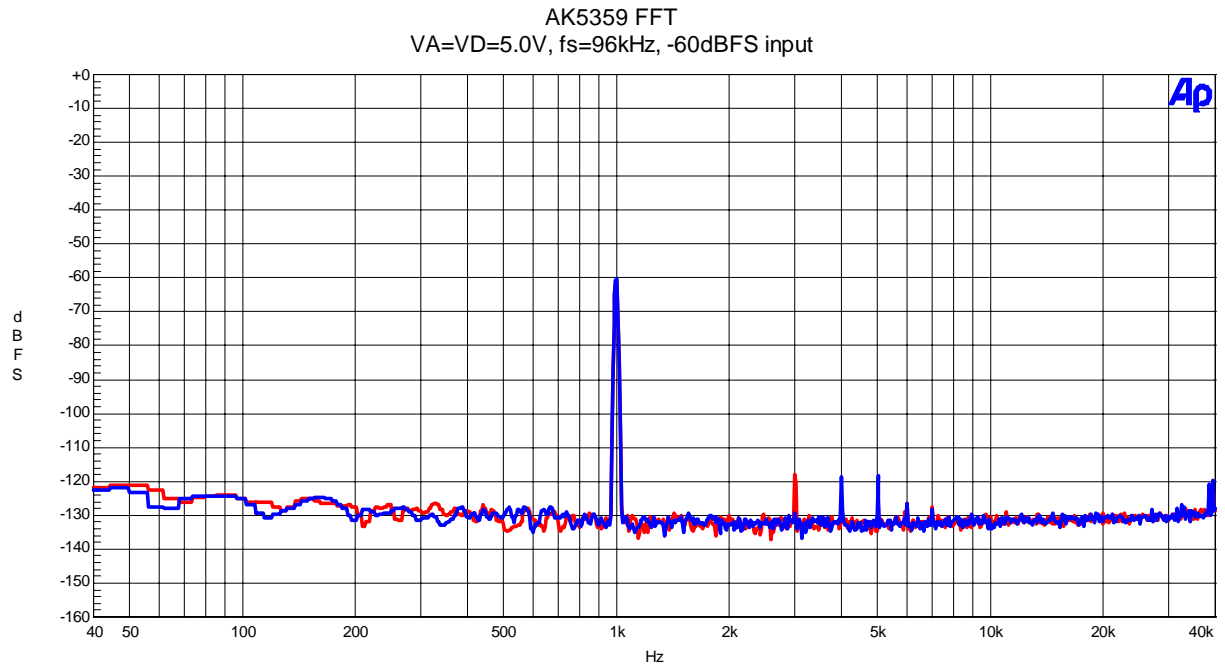

Figure 12 FFT (1kHz, -60dB input)

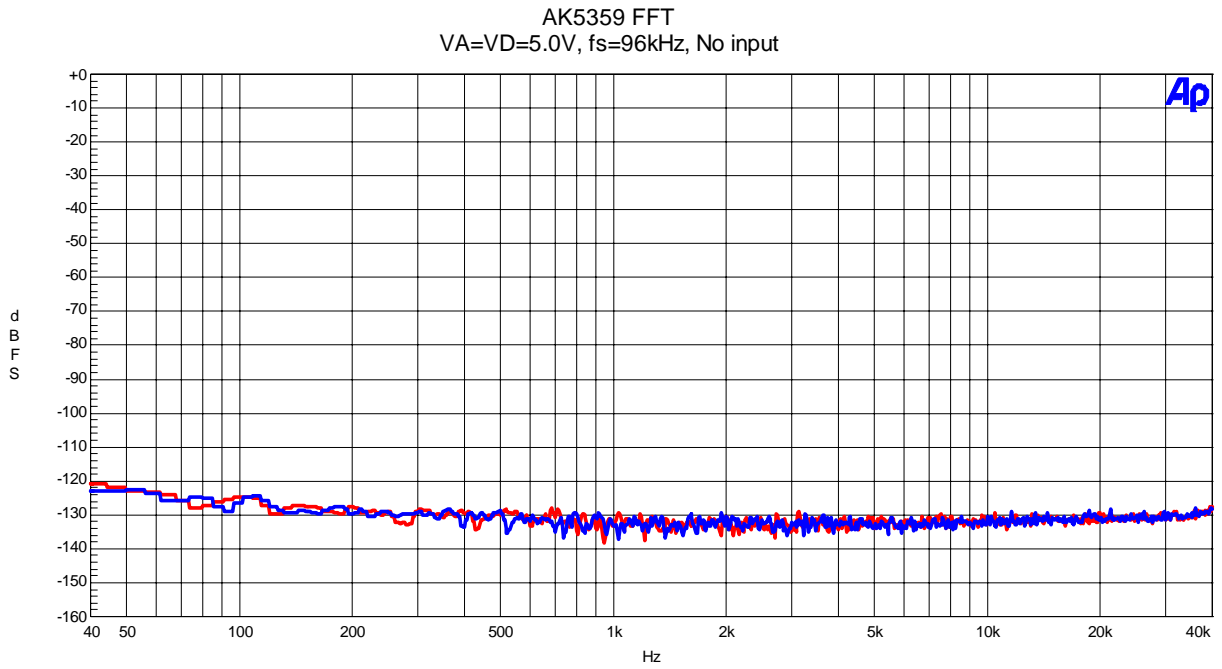

Figure 13 FFT (off the input)

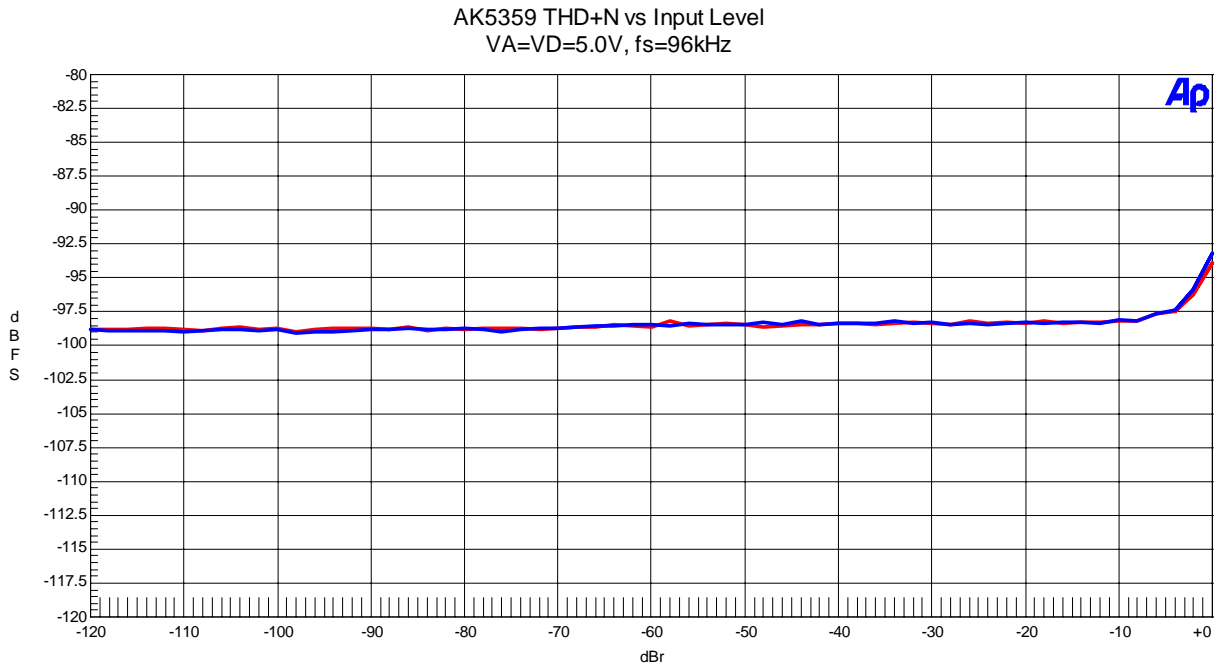

Figure 14 THD+N vs Input Level (1kHz input)

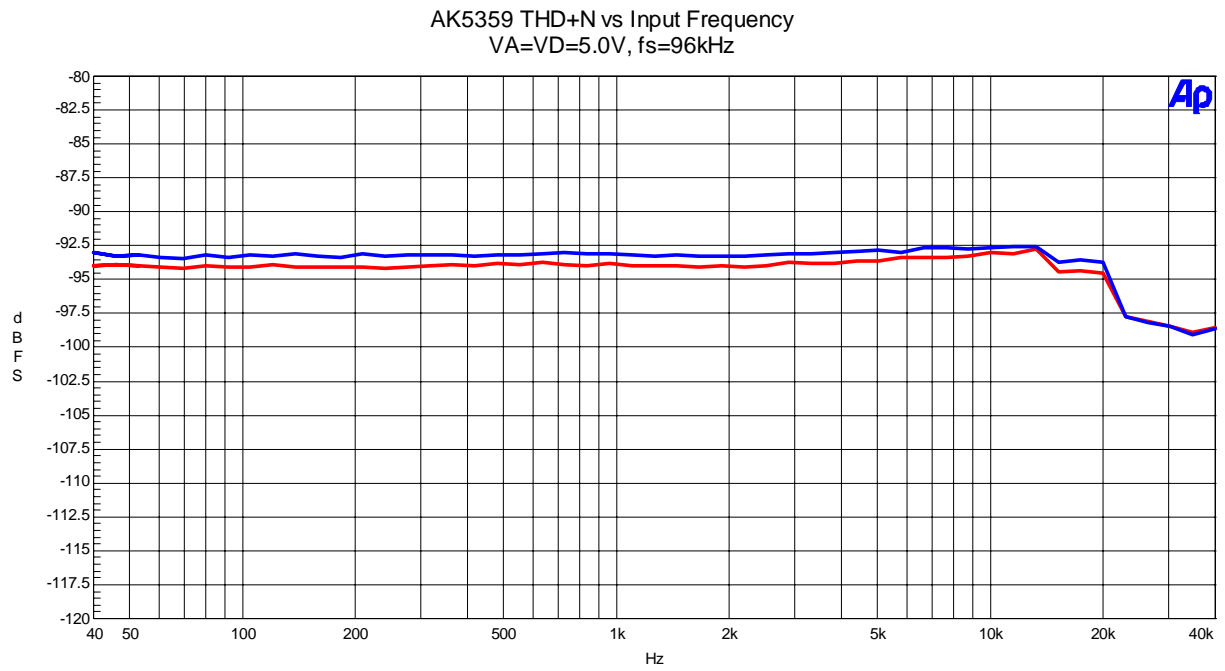

Figure 15 THD+N vs Input Frequency (1kHz input)

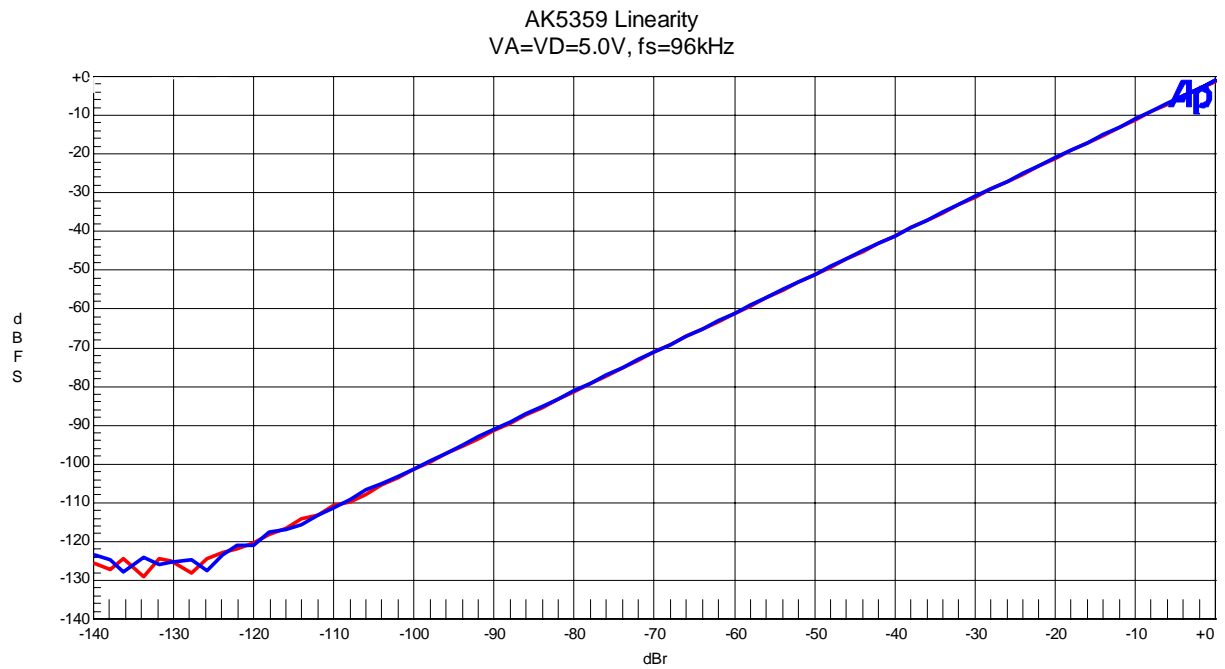

Figure 16 Linearity (fin=1kHz)

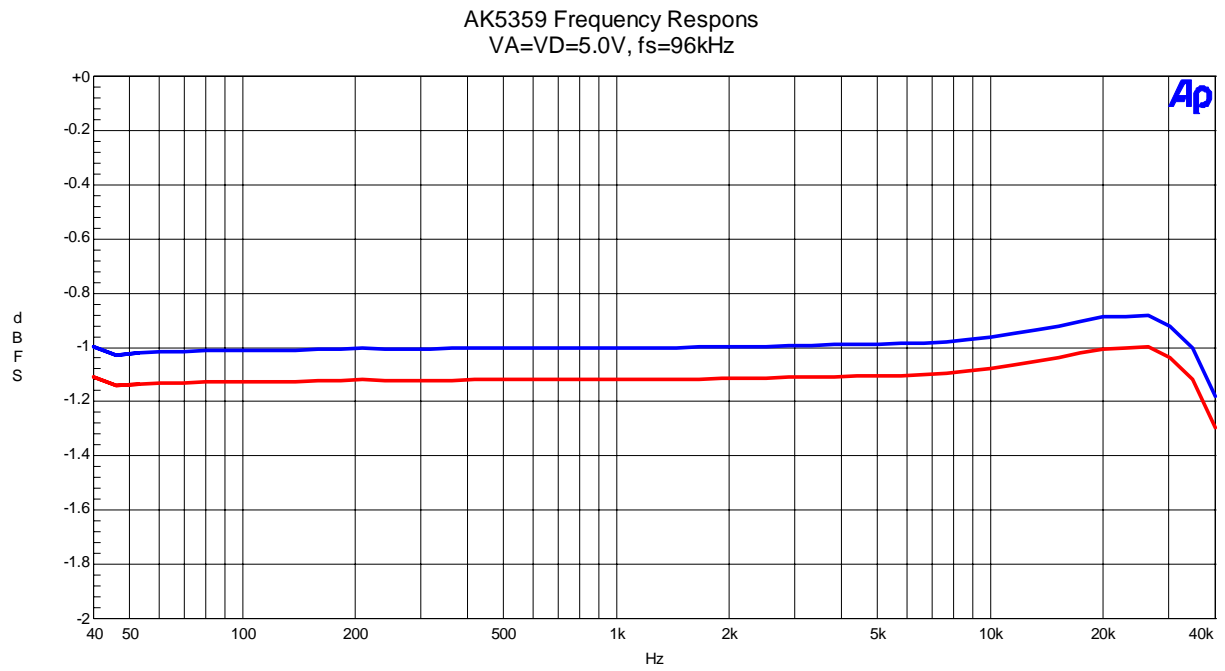

Figure 17 Frequency Response (-1dB input)

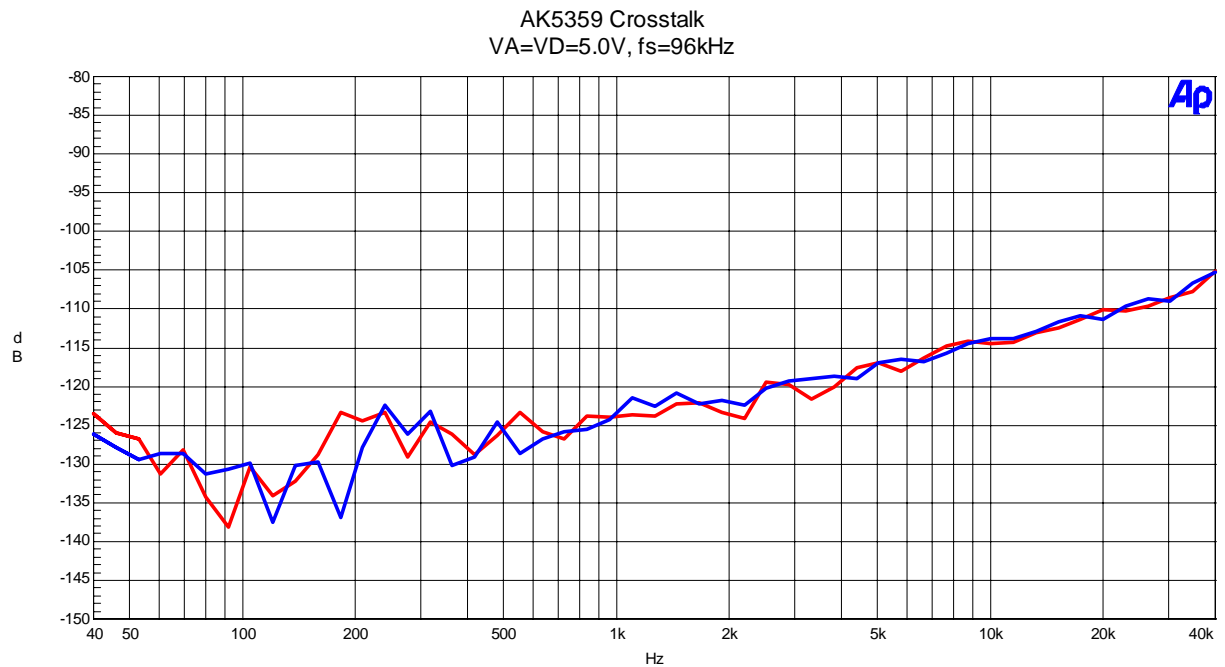

Figure 18 Cross-talk (-1dB input)

fs=192kHz

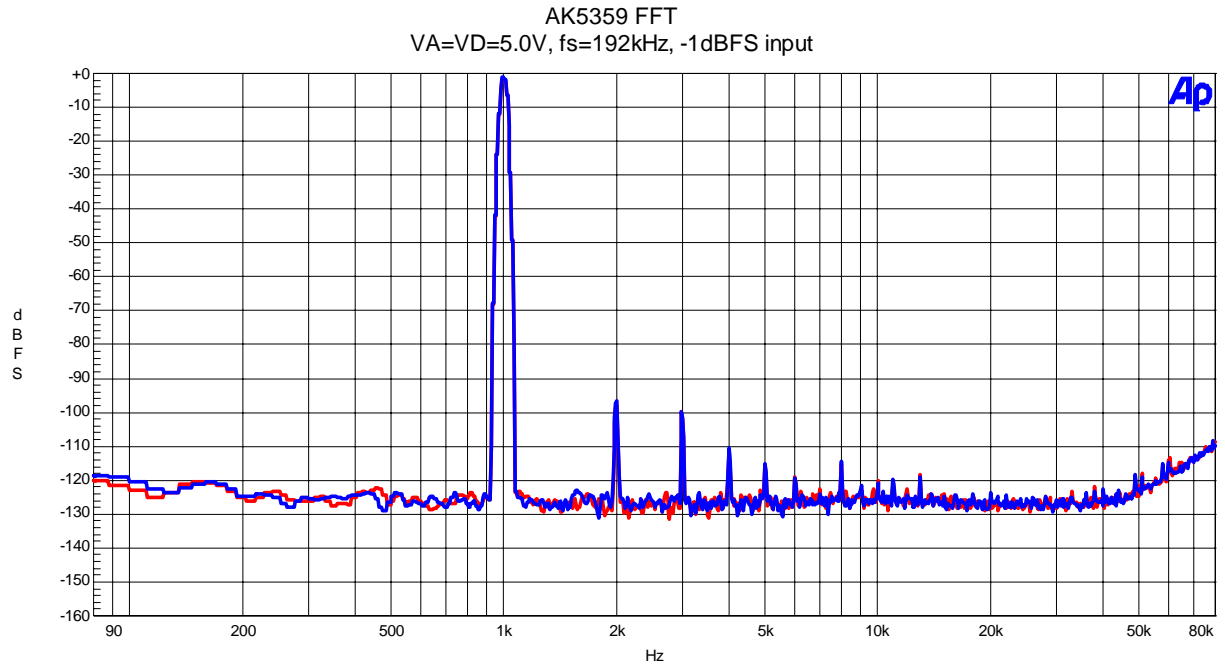

Figure 19 FFT (1kHz, -1dB input)

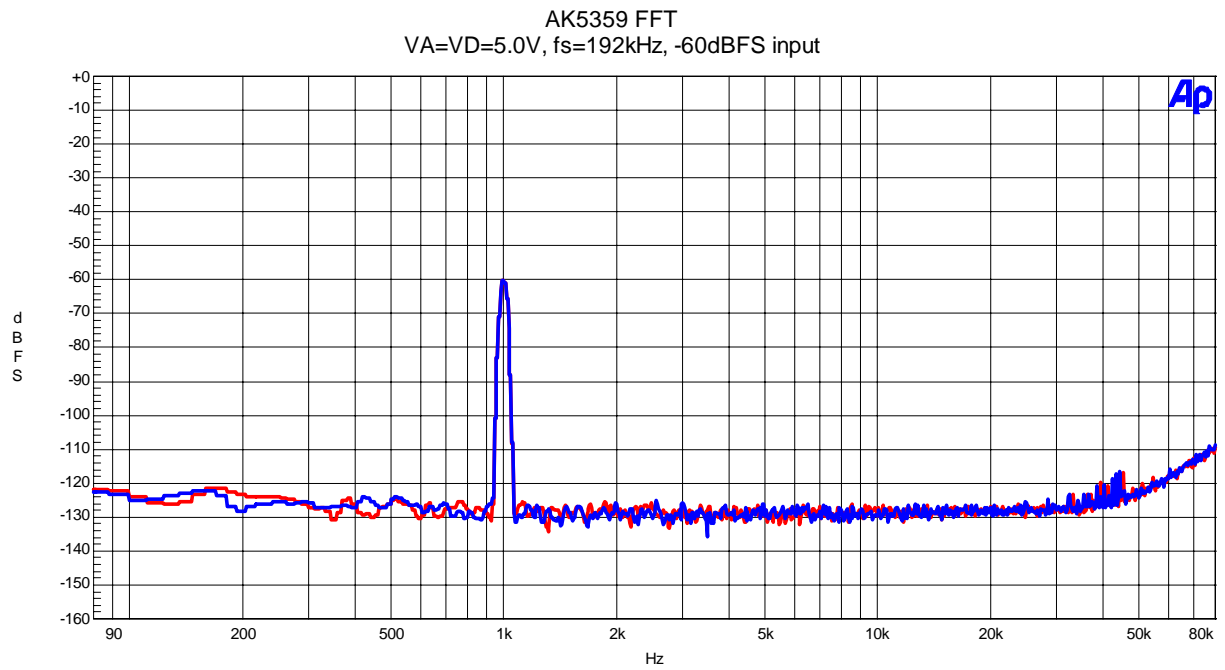

Figure 20 FFT (1kHz, -60dB input)

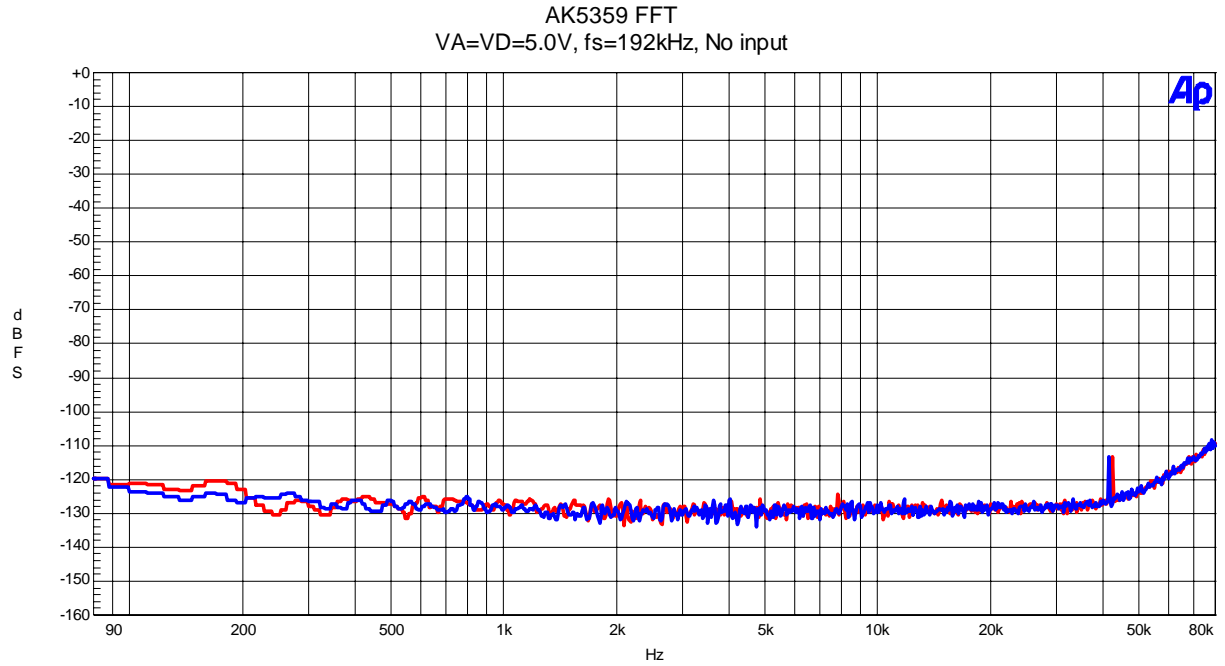

Figure 21 FFT (off the input)

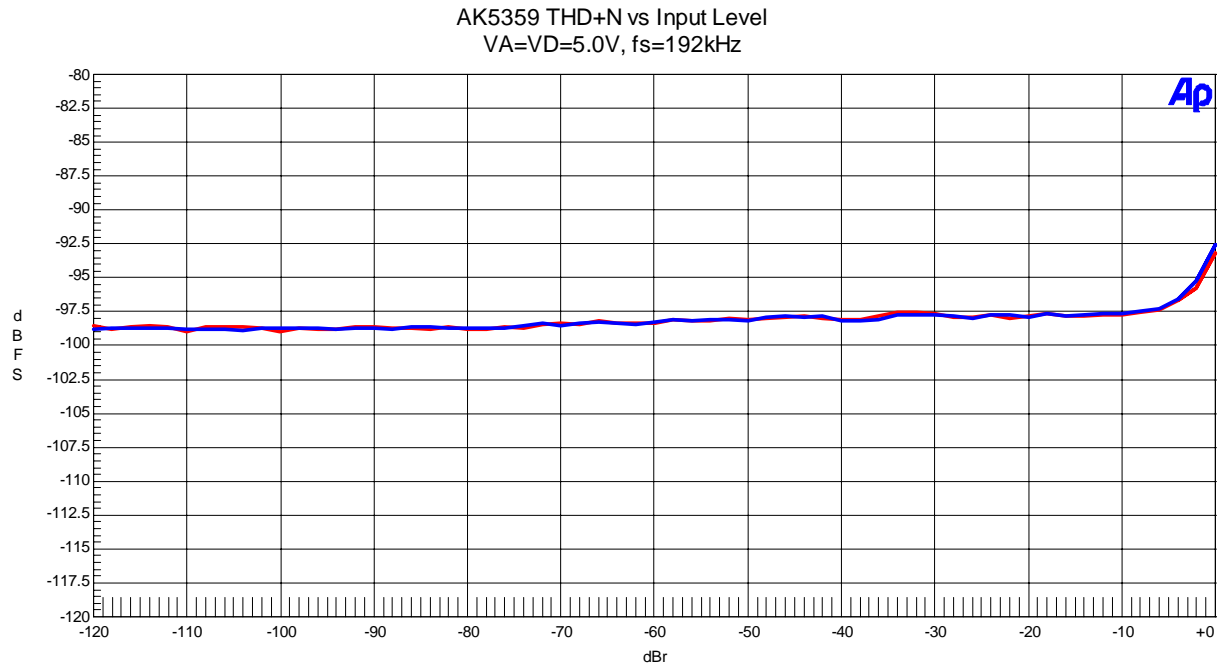

Figure 22 THD+N vs Input Level (-1dB input)

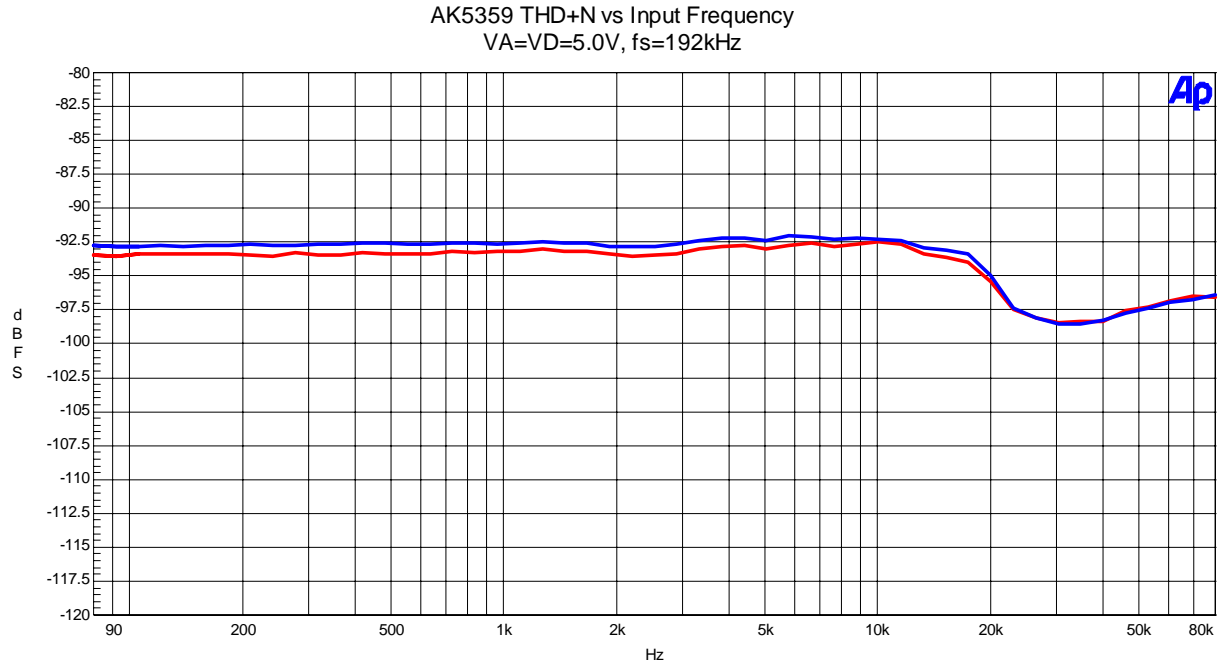

Figure 23 THD+N vs Input Frequency (-1dB input)

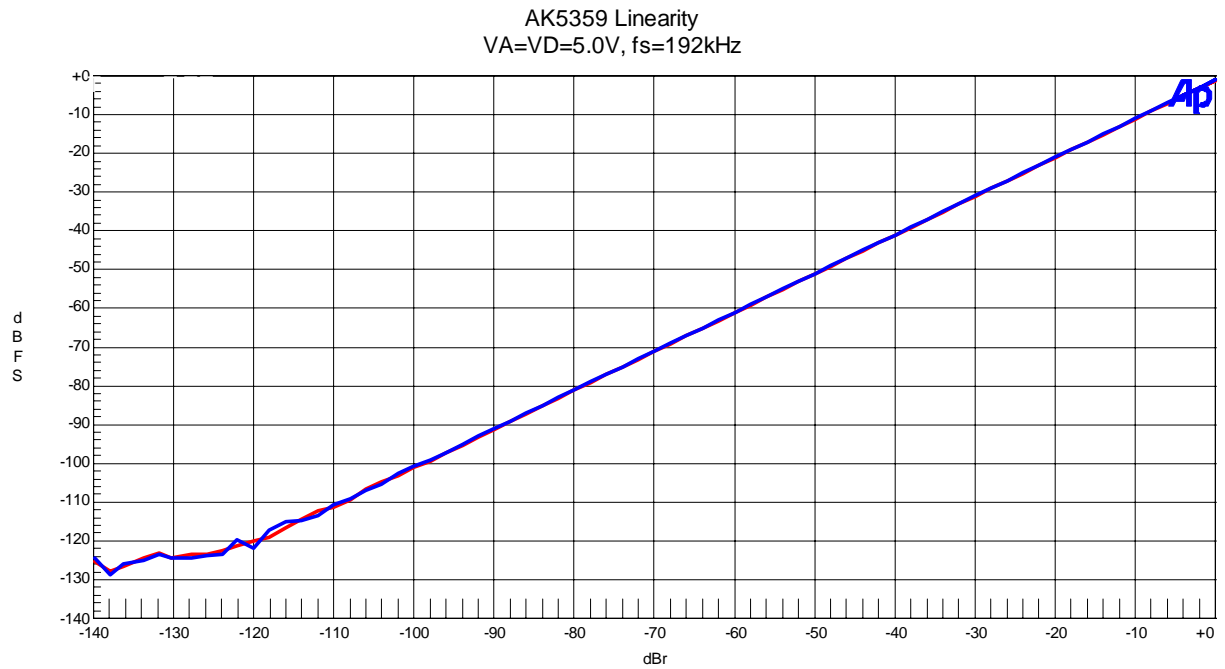

Figure 24 Linearity (fin=1kHz)

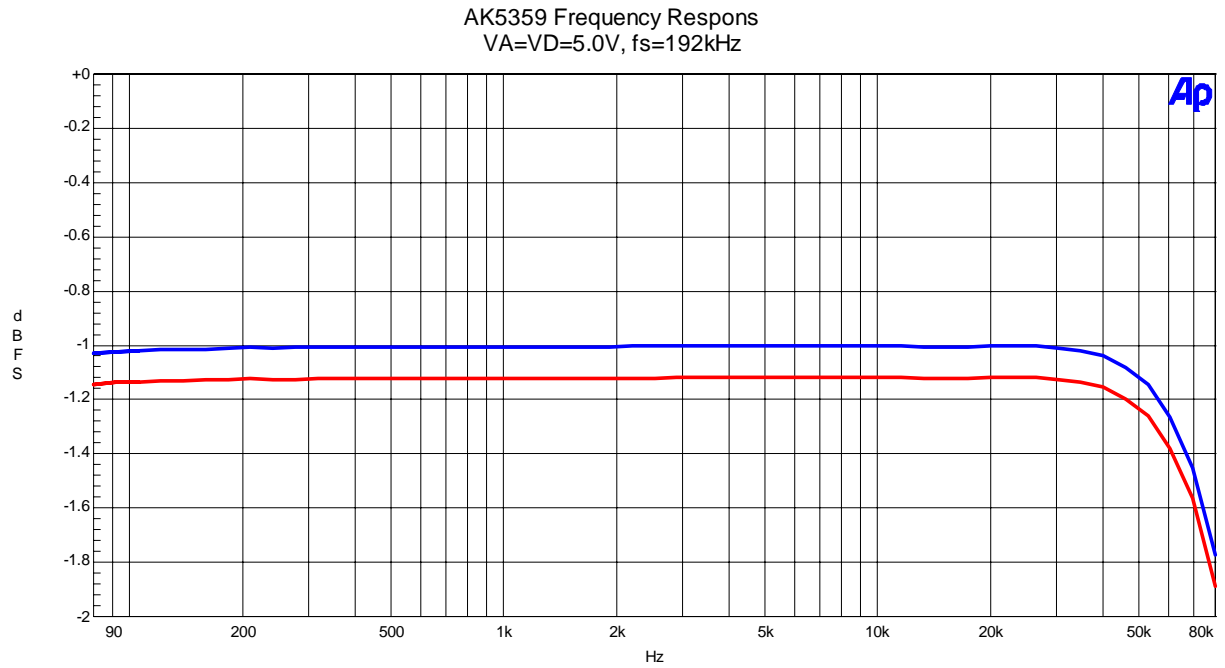

Figure 25 Frequency Response (-1dB input)

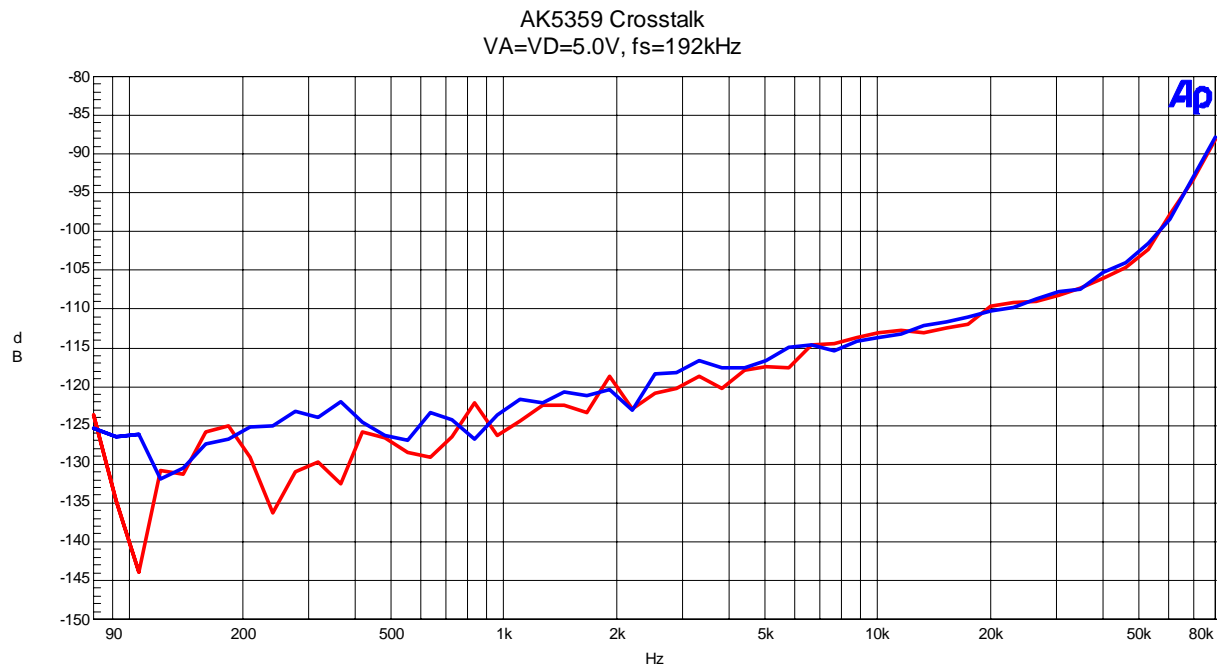

Figure 26 Cross-talk (-1dB input)

Revision History

Date (YY/MM/DD)	Manual Revision	Board Revision	Reason	Contents
04/07/04	KM079700		First Edition	

IMPORTANT NOTICE

- These products and their specifications are subject to change without notice. Before considering any use or application, consult the Asahi Kasei Microsystems Co., Ltd. (AKM) sales office or authorized distributor concerning their current status.
- AKM assumes no liability for infringement of any patent, intellectual property, or other right in the application or use of any information contained herein.
- Any export of these products, or devices or systems containing them, may require an export license or other official approval under the law and regulations of the country of export pertaining to customs and tariffs, currency exchange, or strategic materials.
- AKM products are neither intended nor authorized for use as critical components in any safety, life support, or other hazard related device or system, and AKM assumes no responsibility relating to any such use, except with the express written consent of the Representative Director of AKM. As used here:
 - (a) A hazard related device or system is one designed or intended for life support or maintenance of safety or for applications in medicine, aerospace, nuclear energy, or other fields, in which its failure to function or perform may reasonably be expected to result in loss of life or in significant injury or damage to person or property.
 - (b) A critical component is one whose failure to function or perform may reasonably be expected to result, whether directly or indirectly, in the loss of the safety or effectiveness of the device or system containing it, and which must therefore meet very high standards of performance and reliability.
- It is the responsibility of the buyer or distributor of an AKM product who distributes, disposes of, or otherwise places the product with a third party to notify that party in advance of the above content and conditions, and the buyer or distributor agrees to assume any and all responsibility and liability for and hold AKM harmless from any and all claims arising from the use of said product in the absence of such notification.

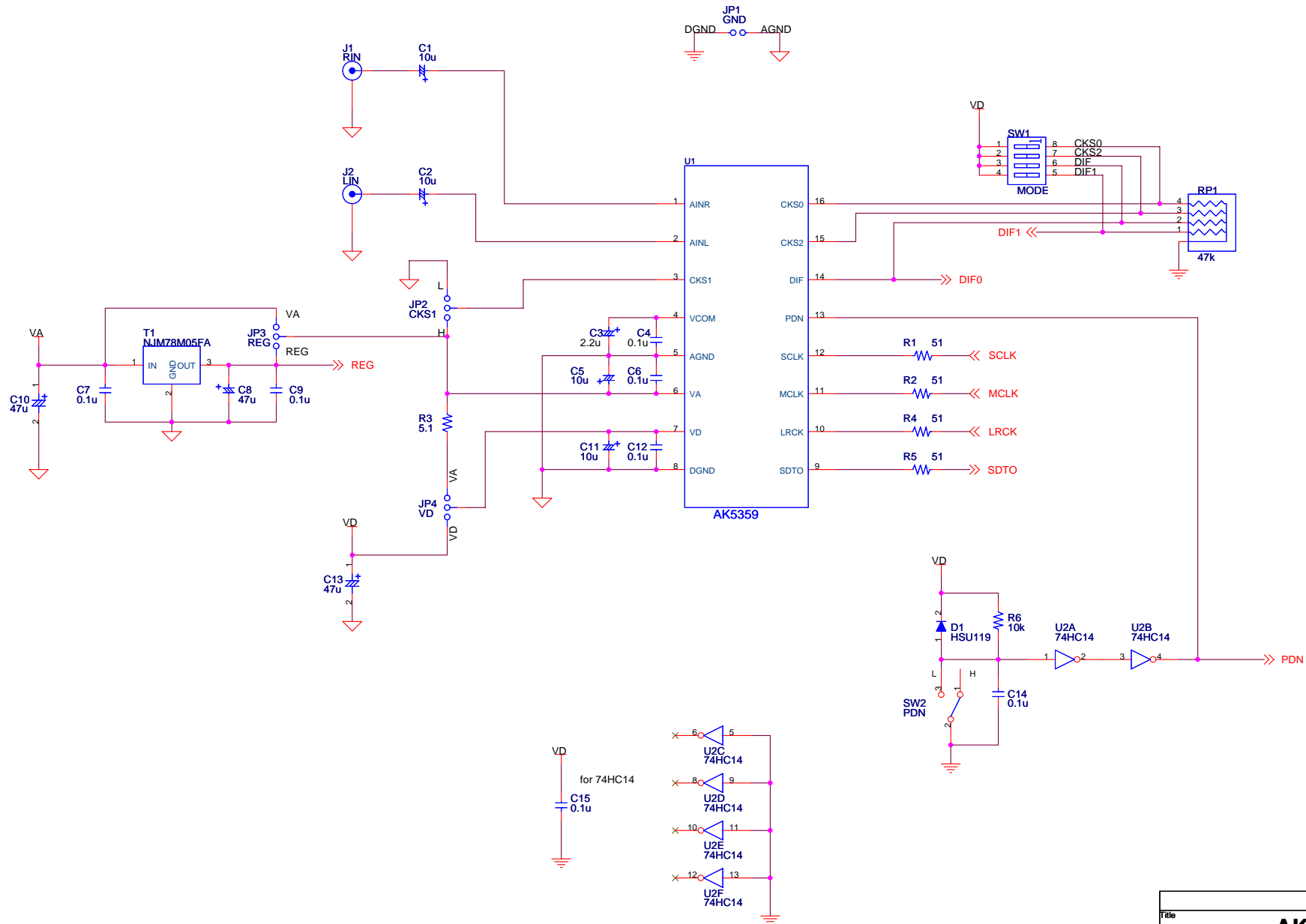

Title		
AKD5359-B		
Size	Document Number	Rev
A3	AK5359	0
Date:	Monday, June 20, 2005	Sheet 1 of 2

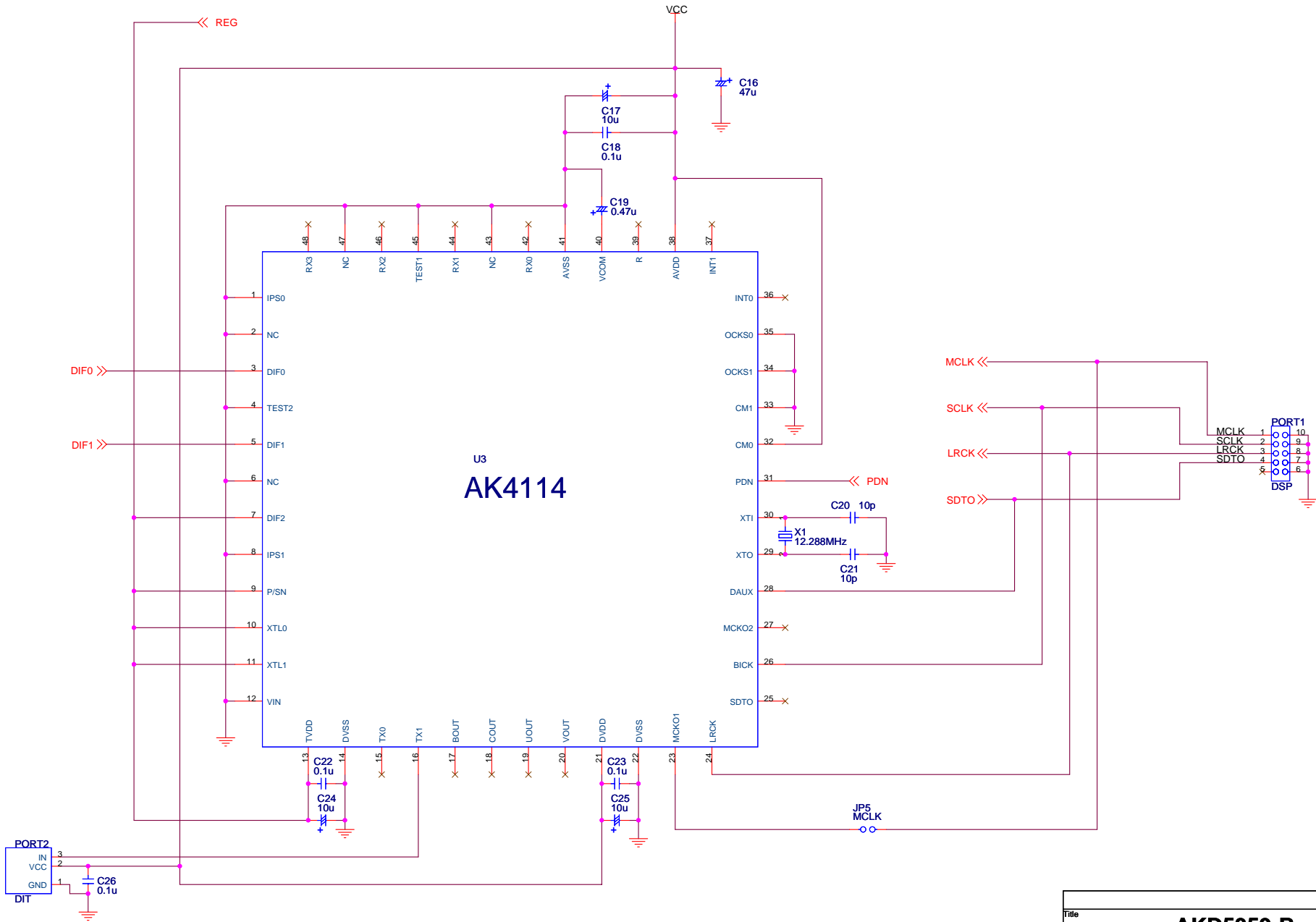

Title		
AKD5359-B		
Size A3	Document Number AK4114	Rev 0
Date: Monday, June 20, 2005	Sheet 2	of 2

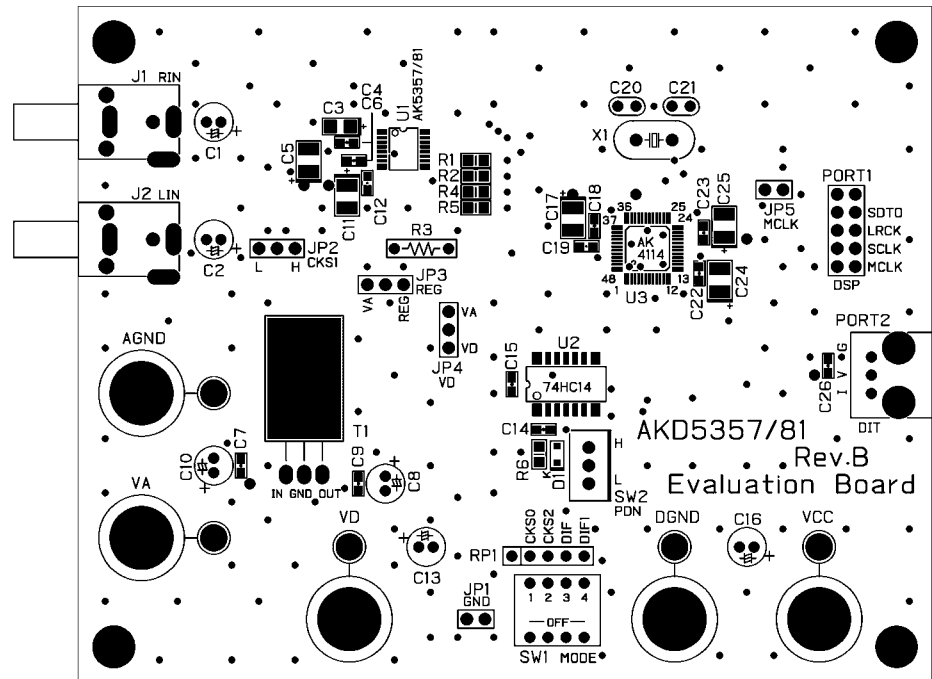

AKD5357/81 Rev.B L1 SR SILK

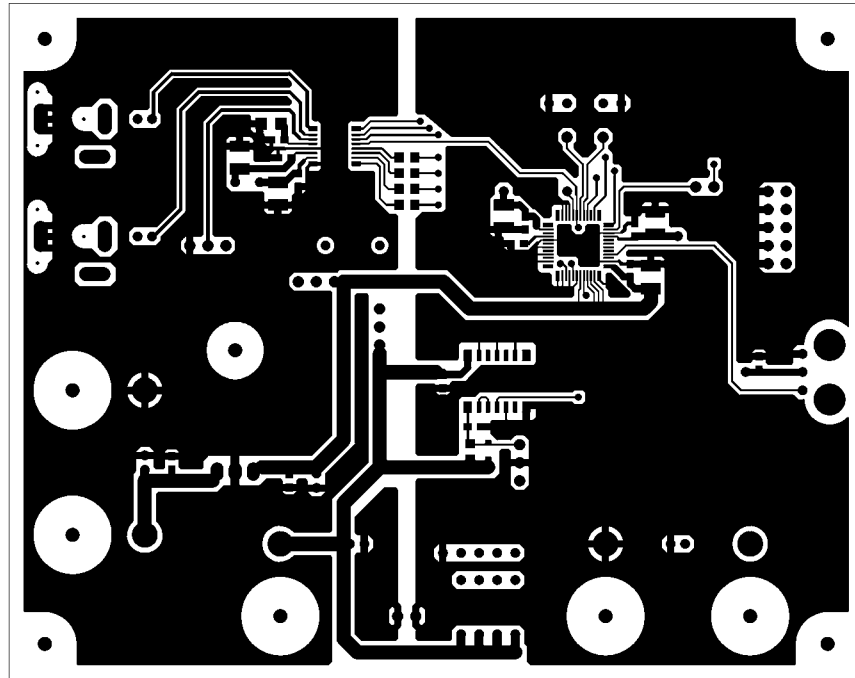

AKD5357/81 Rev.B L1

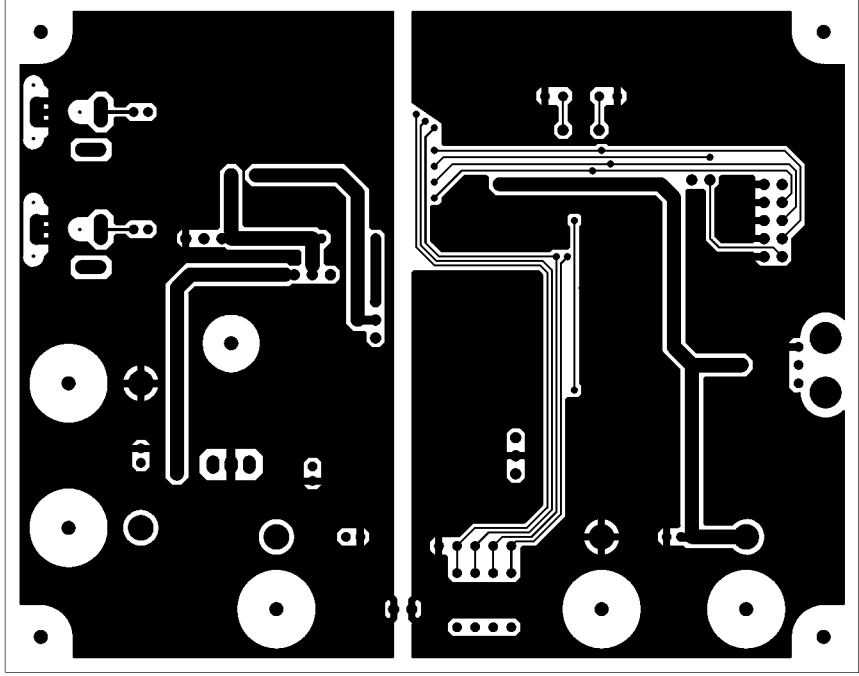

AKD9327\81 Rev.B LS