

# AKD5365

## Evaluation board Rev.A for AK5365

GENERAL DESCRIPTION

AKD5365 is an evaluation board for the digital audio 24bit 96kHz A/D converter, AK5365. The AKD5365 includes the input circuit and also has a digital interface transmitter. Further, the AKD5365 can achieve the interface with digital audio systems via opt-connector.

**■ Ordering guide**

AKD5365 --- Evaluation board for AK5365  
 (Cable for connecting with printer port of IBM-AT, compatible PC and control software are packed with this.)

FUNCTION

- DIT with optical output
- BNC connector for an external clock input
- 10pin Header for serial control mode

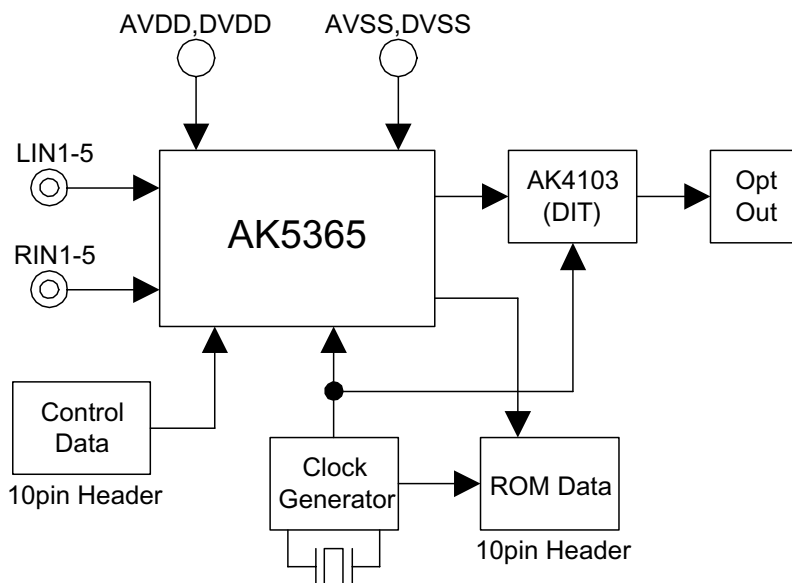

Figure 1. AKD5365 Block Diagram

\* Circuit diagram and PCB layout are attached at the end of this manual.

## 1. Evaluation Board Manual

### ■ Operation sequence

#### 1) Set up the power supply lines.

[AVDD]	(red)	= 4.75 ~ 5.25V	: for AVDD of AK5365 (typ. 5.0V)
[TVDD]	(orange)	= 3.0 ~ 5.25V	: for DVDD of AK5365 (typ. 3.3V)
[D3V]	(orange)	= 3.0 ~ 5.25V	: for 74LVC541 (typ. 3.3V)
[VCC]	(red)	= 5V	: for logic
[AGND]	(black)	= 0V	: for analog ground
[DGND]	(black)	= 0V	: for logic ground

Each supply line should be distributed from the power supply unit.  
D3V and TVDD must be same voltage level.

#### 2) Set up the evaluation mode, jumper pins and DIP switches. (See the followings.)

#### 3) Power on.

The AK5365 and AK4103 should be reset once bringing SW2 = "L" upon power-up.

### ■ Evaluation mode

#### (1) Slave Mode

When evaluating the AK5365 using the AK4103, the setting of the AK5365's audio interface format should be the same as the AK4103's format. The DIF setting of the AK5365 (No.1 of SW1 (I2C) in parallel mode, DIF bit in serial mode) should be the same as the DIF setting of the AK4103 (No.1 of SW3). About the AK5365's audio interface format, refer to AK5365's datasheet. About the AK4103's audio interface format, see Table3.

#### (1-1) A/D evaluation using DIT function of AK4103

PORT1 (DIT) is used. DIT generates audio bi-phase signal from received data and which is output through optical connector (TOTX176). It is possible to connect AKM's D/A converter evaluation boards on the digital-amplifier which equips DIR input. Nothing should be connected to PORT2 (ROM). In case of using external clock through a BNC connector (J13), select EXT on JP8 (CLK) and short JP6 (XTE) and open JP9 (EXT).

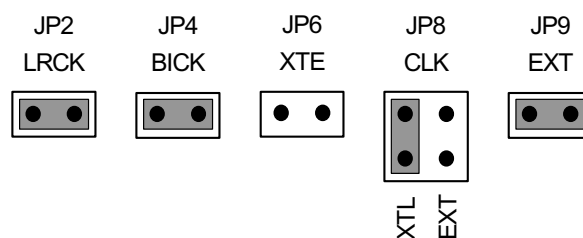

## (2) Master Mode

## (2-1) A/D evaluation using DIT function of AK4103

PORT1 (DIT) is used. DIT generates audio bi-phase signal from received data and which is output through optical connector (TOTX176). It is possible to connect AKM's D/A converter evaluation boards on the digital-amplifier which equips DIR input. Nothing should be connected to PORT2 (ROM). In case of using external clock through a BNC connector (J13), select EXT on JP8 (CLK) and short JP6 (XTE) and open JP9 (EXT).

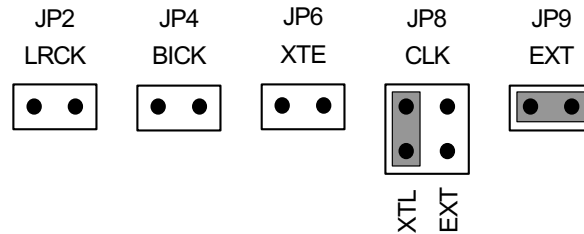

### ■ Other jumper pins set up

1. JP1 (GND) : Analog ground and Digital ground  
 OPEN : Separated.  
 SHORT : Common. (The connector "DGND" can be open.) <Default>
2. JP3 (M/S) : Select Master/Slave mode for AK5365  
 SLAVE : Slave mode <Default>  
 MASTER : Master mode
3. JP5 (TVDD) : Select DVDD for AK5365  
 REG : Supply from regulator  
 TVDD : Supply from TVDD connector <Default>
4. JP7 (MCLK) : MCLK Frequency for 74HC4040  
 256 : MCLK is 256fs. (=12.288MHz@fs=48kHz) <Default>  
 512 : MCLK is 512fs. (=24.576MHz@fs=48kHz)

## ■ DIP Switch set up

[SW1] (MODE1): Setting the evaluation mode for AK5365  
ON is “H”, OFF is “L”. Default is all “L”.

No.	Name	OFF (“L”)	ON (“H”)
1	I2C	Fixed to “L”	
2	CAD0	Fixed to “L”	
3	CAD1	Fixed to “L”	
4	DIF	Fixed to “L”	
5	SEL2	See Table 2	
6	SEL1		
7	SEL0		
8	ALC	ALC Disable	ALC Enable

Table 1. Mode Setting of AK5365

SEL2	SEL1	SEL0	Input Selector	Default
OFF	OFF	OFF	LIN1 / RIN1	
OFF	OFF	ON	LIN2 / RIN2	
OFF	ON	OFF	LIN3 / RIN3	
OFF	ON	ON	LIN4 / RIN4	
ON	OFF	OFF	LIN5 / RIN5	

Table 2. Input Selector

[SW3] (MODE2): Setting the evaluation mode for AK4103  
ON is “H”, OFF is “L”. Default is all “L”.

No.	Name	OFF (“L”)	ON (“H”)
1	DIF	24bit, MSB justified	24bit, I <sup>2</sup> S Compatible
2	CKS1	See Table 4	
3	CKS0		

Table 3. Mode Setting of AK4103

Mode	CKS1	CKS0	MCLK	fs	Default
0	OFF	OFF	256fs	~ 96kHz	
1	OFF	ON	N/A	N/A	
2	ON	OFF	512fs	~ 48kHz	
3	ON	ON	384fs	~ 48kHz	

Table 4. MCLK Frequency Setting of AK4103

## ■ The function of the toggle SW

Upper-side is “H” and lower-side is “L”.

[SW2] (PDN): Resets the AK5365 and AK4103. Keep “H” during normal operation.

[SW4] (SMUTE): Soft mute of AK5365.

■ Serial Control

The AK5365 can be controlled via the printer port (parallel port) of IBM-AT compatible PC. Connect PORT3 (CTRL) with PC by 10-line flat cable packed with the AKD5365. The control software packed with this evaluation board does not support I<sup>2</sup>C control.

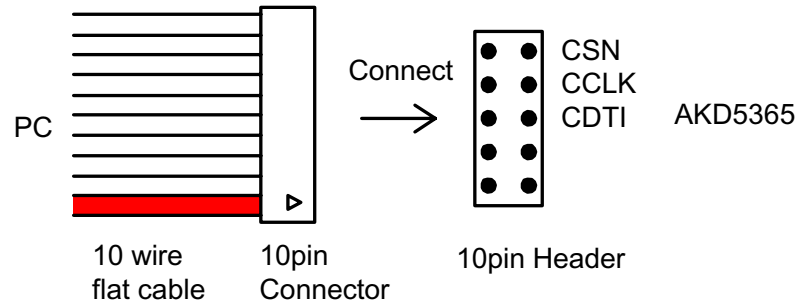

Figure 2. Connect of 10-line flat cable

■ Input/Output Circuits

(1) Input Circuit

Analog signal is input to LIN1-5/RIN1-5 pins via J1 ~ J12 connectors.

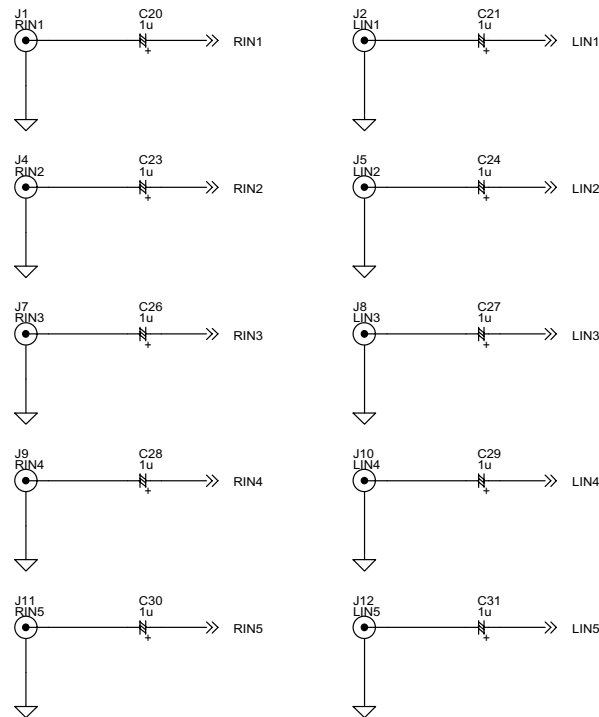

Figure 3. LIN1-5/RIN1-5 Input circuits

The cut-off frequency of the input circuit on this evaluation board is as below. When changing the cut-off frequency, change the constant of the each resistor and capacitor.

- (1) The cut-off frequency of HPF in front of the Pre-Amp :  $f_c = 3.4\text{Hz}$  ( $R = 47\text{k}\Omega$ ,  $C = 1\mu\text{F}$ )
- (2) The cut-off frequency of HPF, which is composed by the input resistance of the IPGAL/R pins and the capacitor of between the Pre-Amp output and the IPGA input :  $f_c = 3.4\text{Hz}$ . ( $R = 10\text{k}\Omega$ ,  $C = 4.7\mu\text{F}$ )

## (2) Output Circuit

Signal of LOUT and ROUT pins are output via J3 (LOUT) and J6 (ROUT).

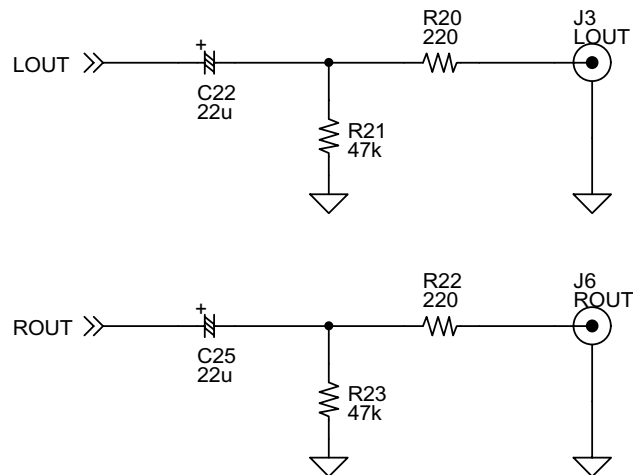

Figure 4. LOUT/ROUT Output circuits

\* AKM assumes no responsibility for the trouble when using the circuit examples.

## 2. Control Software Manual

### ■ Set-up of evaluation board and control software

#### The control software packed with this evaluation board does not support I<sup>2</sup>C control.

1. Set up the AKD5365 according to previous term.
2. Connect IBM-AT compatible PC with the AKD5365 by 10-line type flat cable (packed with the AKD5365). Take care not to insert the 10pin header to the wrong direction. (This control software does not operate on Windows NT/2000/XP, therefore please operate it on Windows95/98/Me.)
3. Insert the floppy-disk labeled “AKD5365 Control Program ver 1.0” into the floppy-disk drive.
4. Access the floppy-disk drive and double-click the icon of “akd5365.exe” to set up the control program.
5. Then please evaluate according to the follows.

### ■ Operation flow

Keep the following flow.

1. Set up the control program according to explanation above.
2. Click “Port Setup” button.
3. Click “Write default” button.
4. Then set up the dialog and input data.

### ■ Explanation of each buttons

1. [Port Setup] : Set up the printer port.
2. [Write default] : Initialize the register of AK5365.
3. [Function1] : Dialog to write data by keyboard operation.
4. [Function2] : Dialog to evaluate IPGA.
5. [Write] : Dialog to write data by mouse operation.

### ■ Explanation of each dialog

1. [Function1 Dialog] : Dialog to write data by keyboard operation

Address Box: Input register address in 2 figures of hexadecimal.

Data Box: Input register data in 2 figures of hexadecimal.

If you want to write the input data to AK5365, click “OK” button. If not, click “Cancel” button.

## 2. [Function2 Dialog] : Dialog to evaluate IPGA

This dialog corresponds to only addr=04H, 05H.

Address Box: Input register address in 2 figures of hexadecimal.

Start Data Box: Input start data in 2 figures of hexadecimal.

End Data Box: Input end data in 2 figures of hexadecimal.

Interval Box: Data is written to AK5365 by this interval.

Step Box: Data changes by this step.

Mode Select Box:

If you check this check box, data reaches end data, and returns to start data.

[Example] Start Data = 00, End Data = 09

Data flow: 00 01 02 03 04 05 06 07 08 09 09 08 07 06 05 04 03 02 01 00

If you do not check this check box, data reaches end data, but does not return to start data.

[Example] Start Data = 00, End Data = 09

Data flow: 00 01 02 03 04 05 06 07 08 09

If you want to write the input data to AK5365, click "OK" button. If not, click "Cancel" button.

## 3. [Write Dialog] : Dialog to write data by mouse operation

There are dialogs corresponding to each register.

Click the "Write" button corresponding to each register to set up the dialog. If you check the check box, data becomes "H" or "1". If not, "L" or "0".

If you want to write the input data to AK5365, click "OK" button. If not, click "Cancel" button.

### ■ Indication of data

Input data is indicated on the register map. Red letter means "H" or "1" and blue one means "L" or "0". Blank means the part that is not defined in the datasheet.

### ■ Attention on the operation

If you set up Function1 or Function2 dialog, input data to all boxes. Attention dialog is indicated if you input data or address that is not specified in the datasheet or you click "OK" button before you input data. In that case set up the dialog and input data once more again. If you click "Cancel" button during operation, the operation is cancelled and returns to the initial window.



<b>MEASUREMENT RESULTS</b>
----------------------------

## [Measurement condition]

- Measurement unit : Audio Precision, System Two Cascade
- MCLK : 256fs
- BICK : 64fs
- fs : 48kHz, 96kHz
- Bit : 24bit
- Power Supply : AVDD = 5.0V, DVDD = 3.3V
- Interface : DIT
- Temperature : Room
- External Condition : Input resistor (Ri) = 47k $\Omega$ , Feedback resistor (Rf) = 24k $\Omega$
- IPGA Gain : 0dB

Parameter	Result (Lch / Rch)	Unit
<b>Pre-Amp Characteristics:</b>		
S/(N+D)	105.8 / 102.5	dB
S/N (A-weighted)	108.6 / 108.6	dB
<b>ADC Analog Input Characteristics: LIN1/RIN1 → Pre-Amp → IPGA → ADC, IPGA=0dB, ALC=OFF</b>		
S/(N+D) (-0.5dB Input)	fs=48kHz	95.6 / 96.6
	fs=96kHz	91.2 / 91.9
D-Range (-60dB Input)	fs=48kHz, A-weighted	103.3 / 103.4
	fs=96kHz	98.6 / 98.6
S/N	fs=48kHz, A-weighted	103.3 / 103.4
	fs=96kHz	98.6 / 98.6
Interchannel Isolation	115.5 / 116.5	dB

[ADC Plot : fs=48kHz]

AK5365 THD+N vs. Input Level  
AVDD=5.0V, DVDD=3.3V, fs=48kHz, fin=1kHz

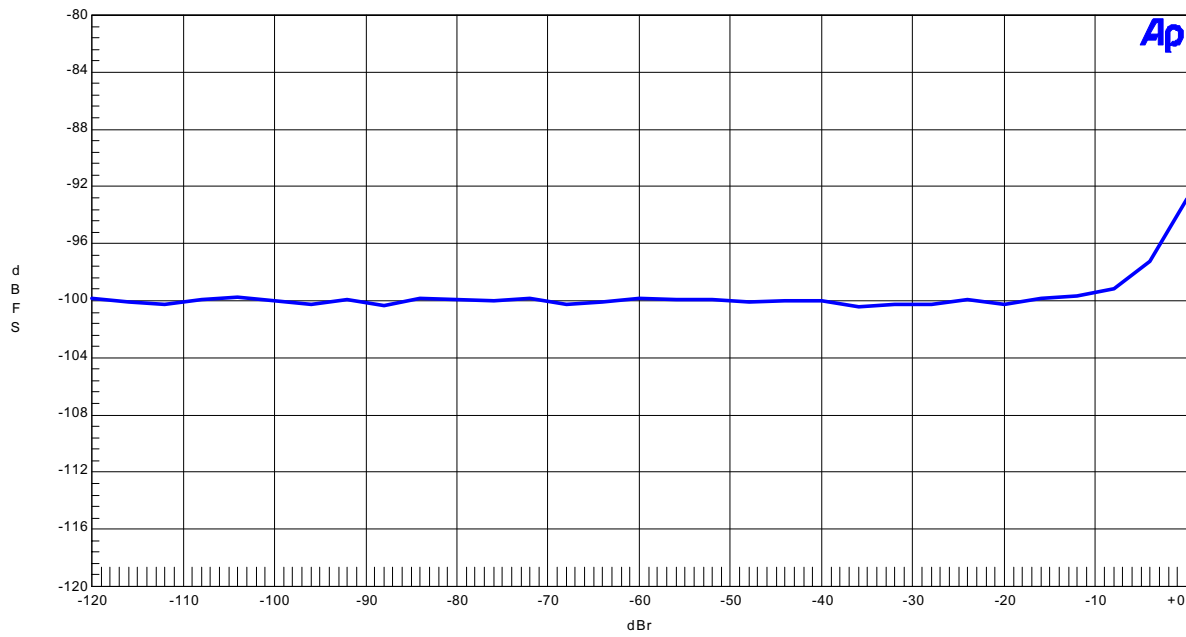

Figure 1. THD+N vs. Input Level

AK5365 THD+N vs. Input Frequency  
AVDD=5.0V, DVDD=3.3V, fs=48kHz, Input=-0.5dBr

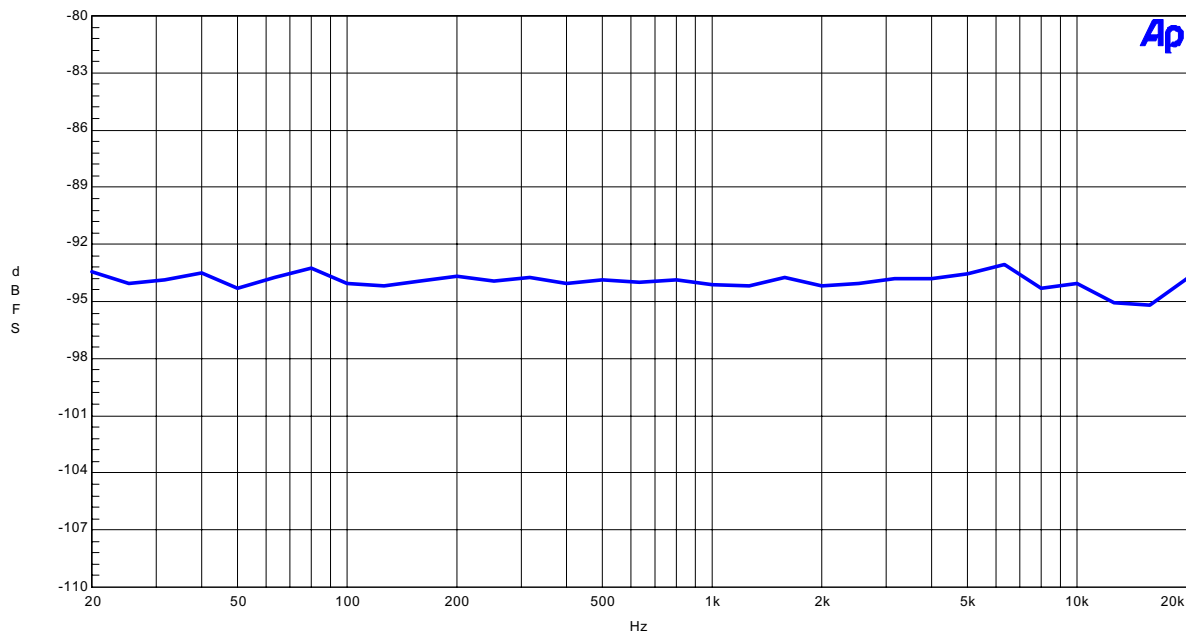

Figure 2. THD+N vs. Input Frequency

AK5365 Linearity  
 AVDD=5.0V, DVDD=3.3V, fs=48kHz, fin=1kHz

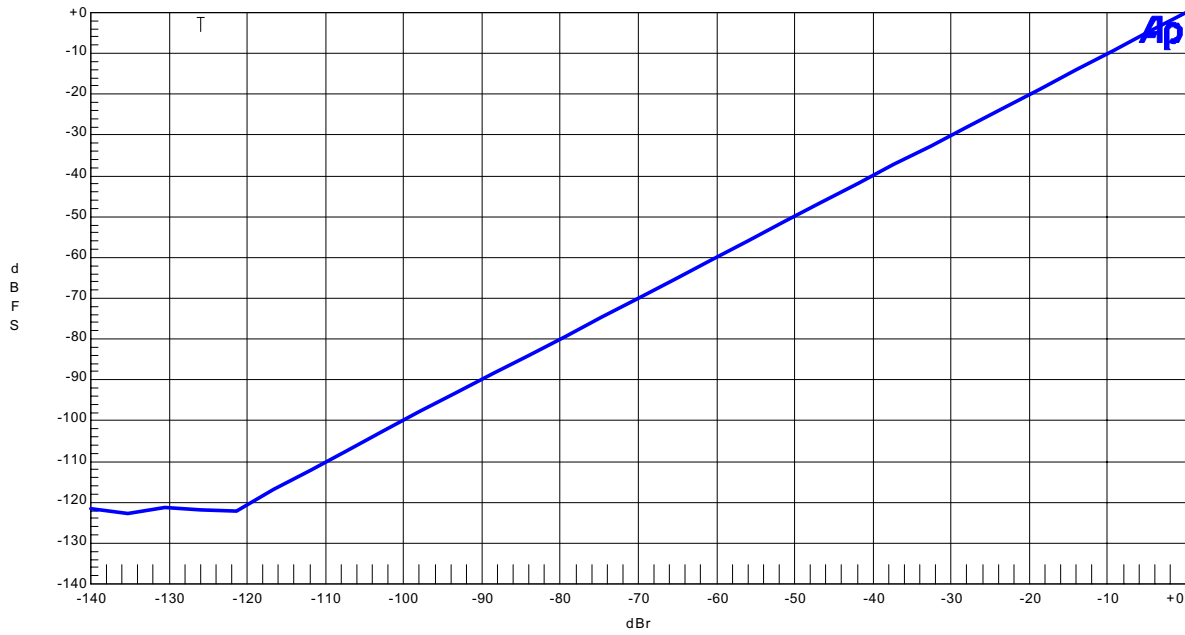

Figure 3. Linearity

AK5365 Frequency Response  
 AVDD=5.0V, DVDD=3.3V, fs=48kHz, Input=0dBr

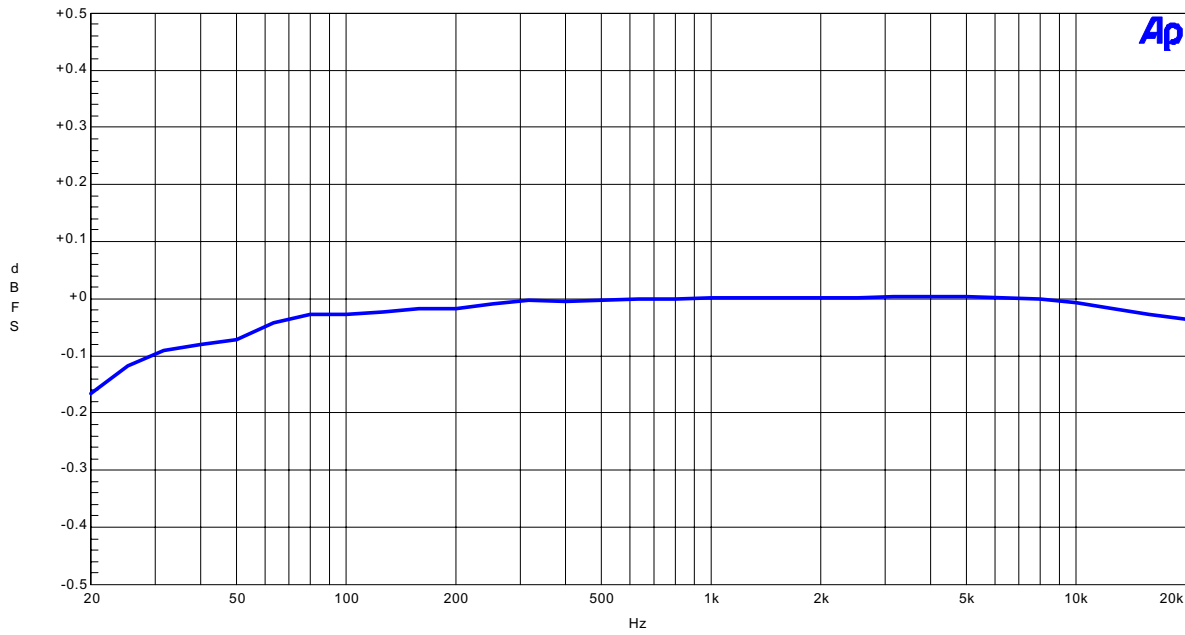

Figure 4. Frequency Response

AK5365 Crosstalk  
AVDD=5.0V, DVDD=3.3V, fs=48kHz, Input=-0.5dBr

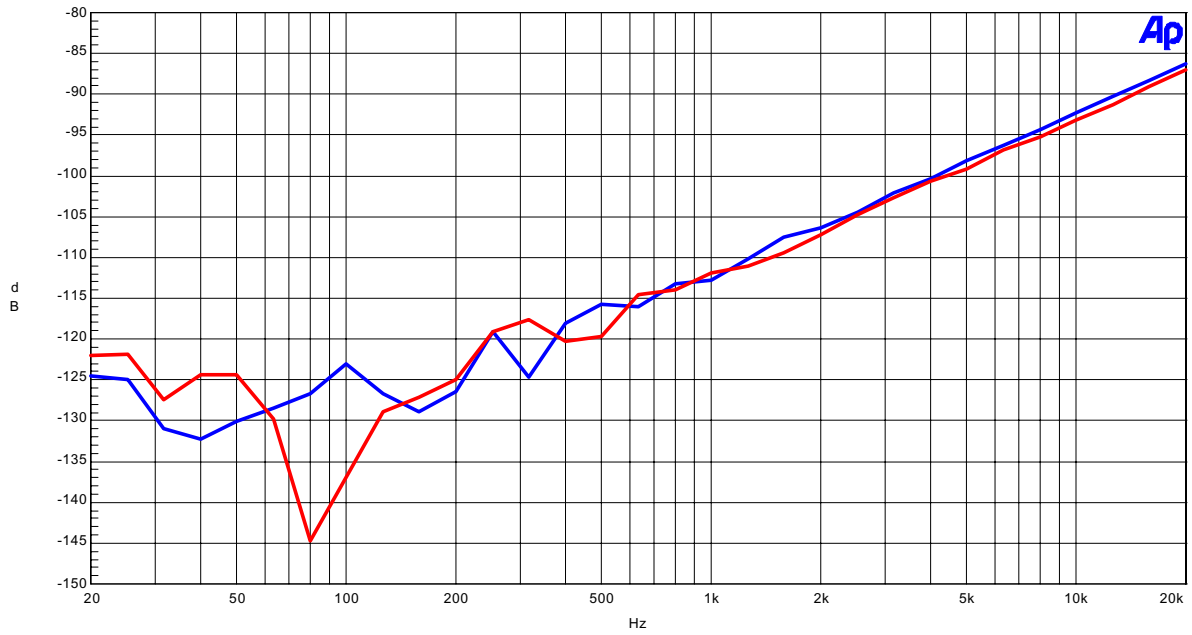

Figure 5. Crosstalk

AK5365 FFT Plot  
AVDD=5.0V, DVDD=3.3V, fs=48kHz, Input=-0.5dBr, fin=1kHz

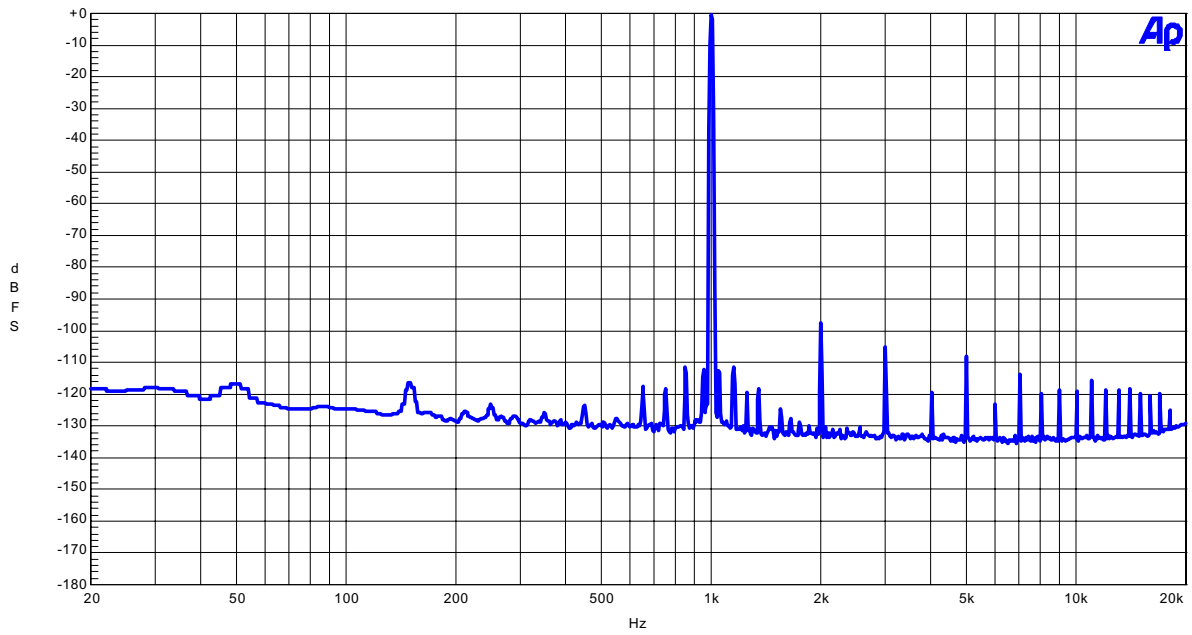

Figure 6. FFT Plot

AK5365 FFT Plot  
AVDD=5.0V, DVDD=3.3V, fs=48kHz, Input=-60dB<sub>r</sub>, fin=1kHz

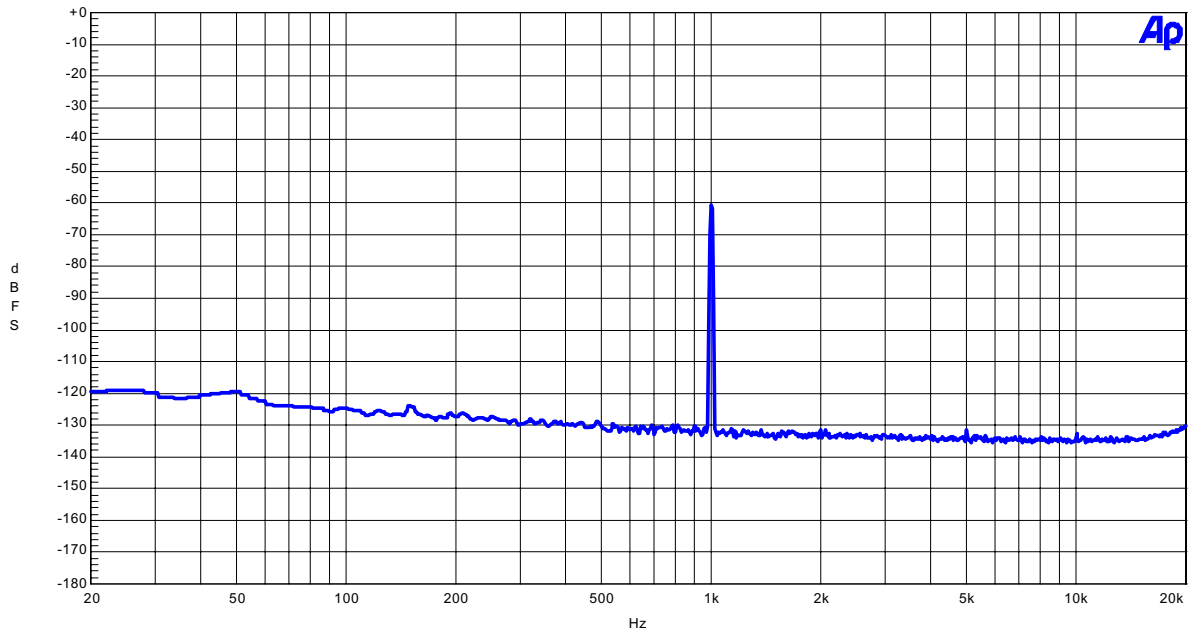

Figure 7. FFT Plot

AK5365 FFT Plot  
AVDD=5.0V, DVDD=3.3V, fs=48kHz, fin=None

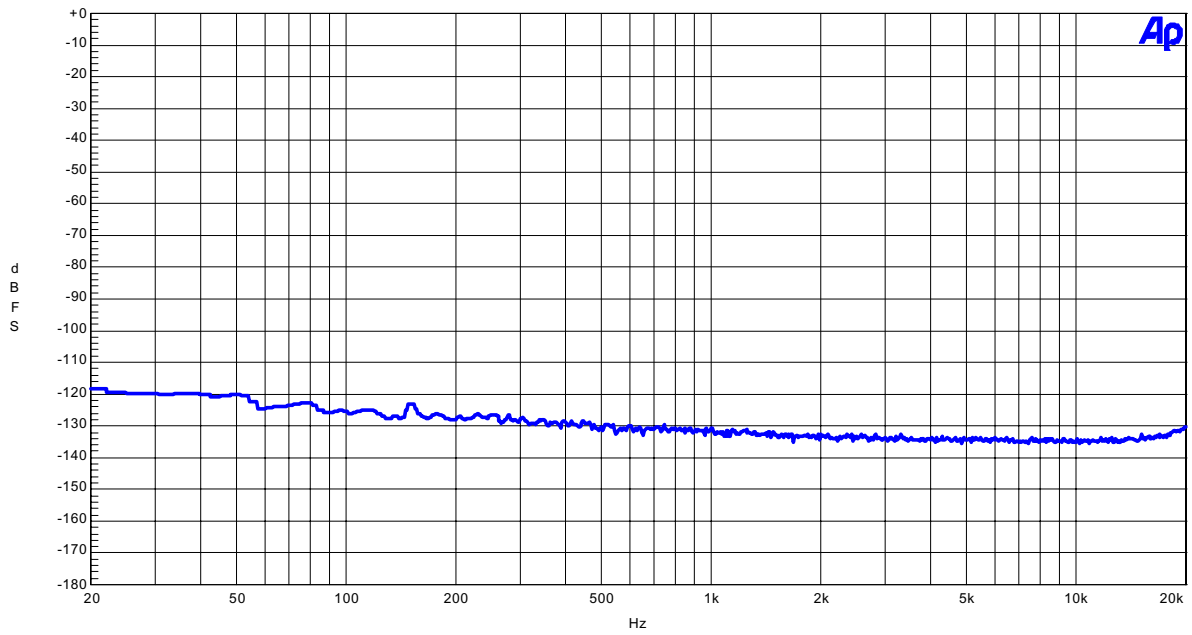

Figure 8. FFT Plot

[ADC Plot : fs=96kHz]

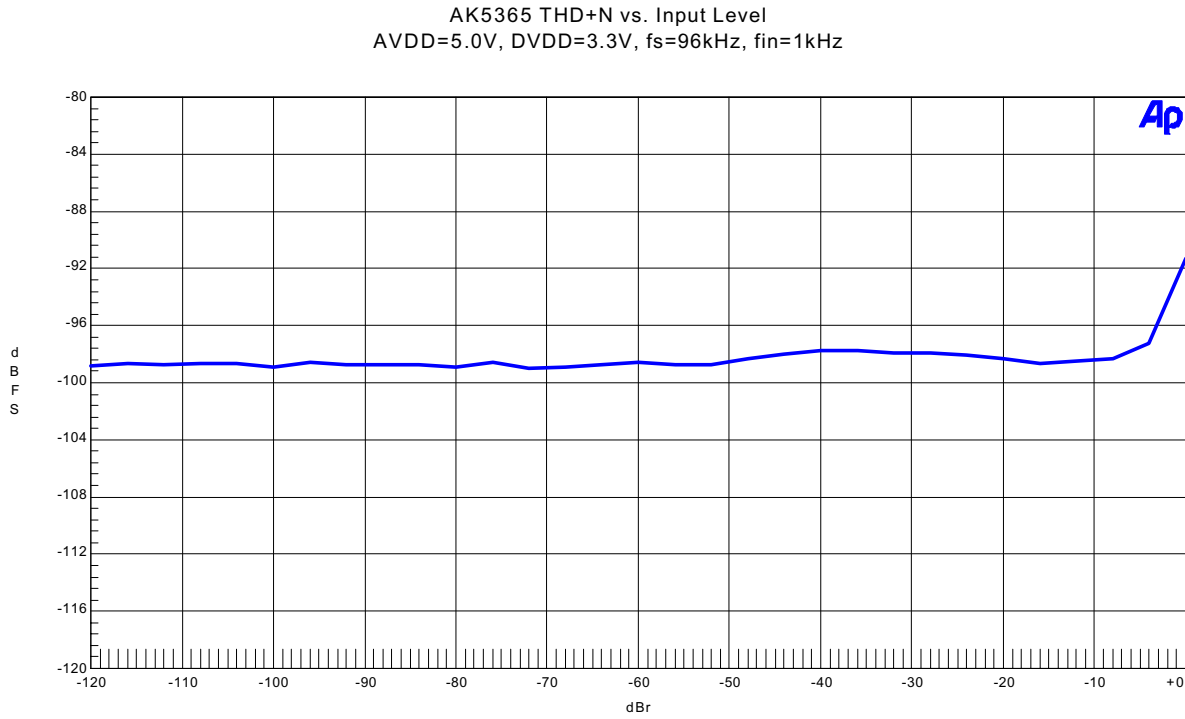

Figure 9. THD+N vs. Input Level

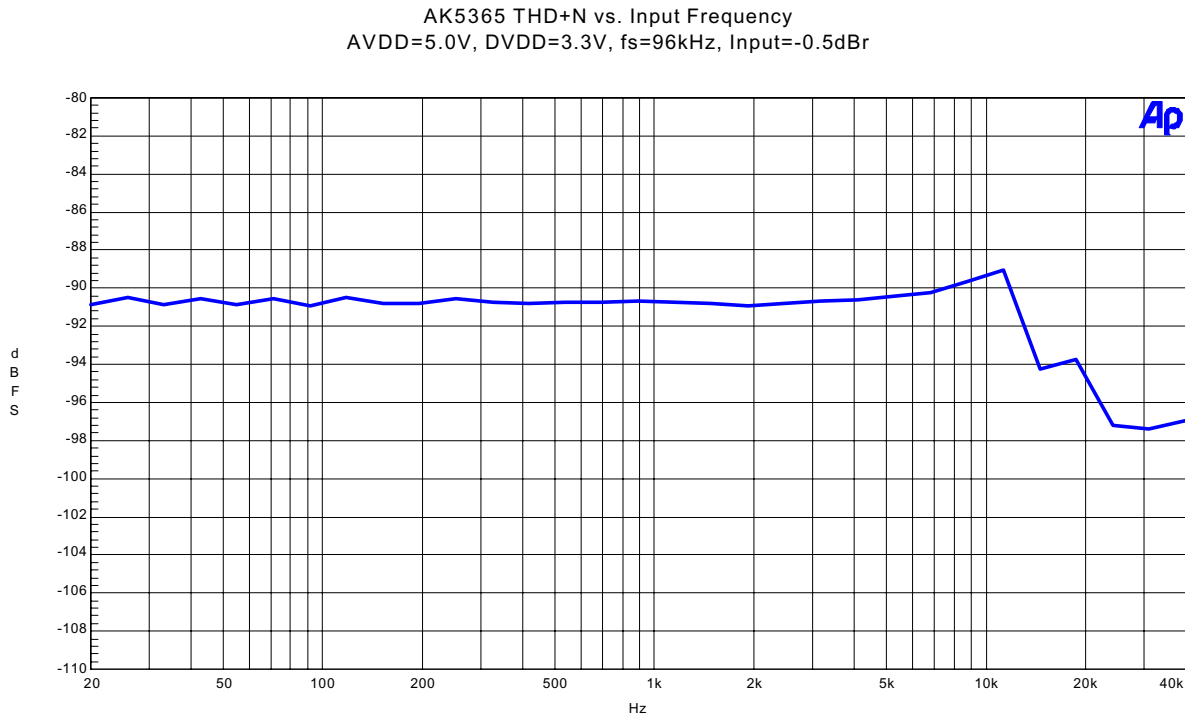

Figure 10. THD+N vs. Input Frequency

AK5365 Linearity  
AVDD=5.0V, DVDD=3.3V, fs=96kHz, fin=1kHz

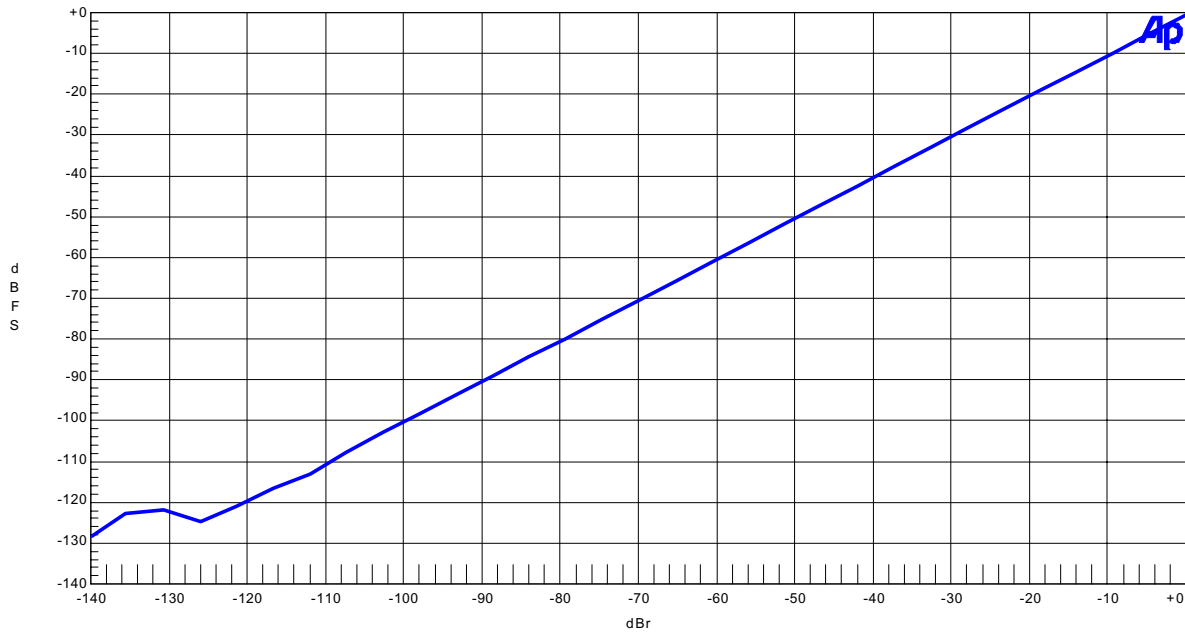

Figure 11. Linearity

AK5365 Frequency Response  
AVDD=5.0V, DVDD=3.3V, fs=96kHz, Input=0dBr

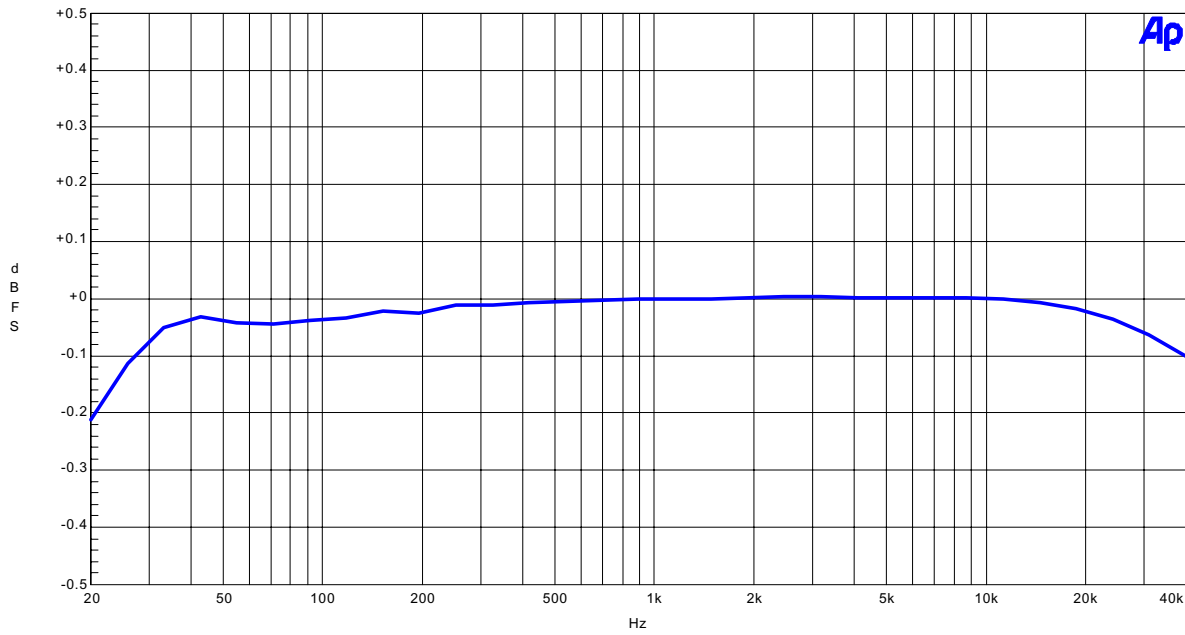

Figure 12. Frequency Response

AK5365 Crosstalk  
AVDD=5.0V, DVDD=3.3V, fs=96kHz, Input=-0.5dBr

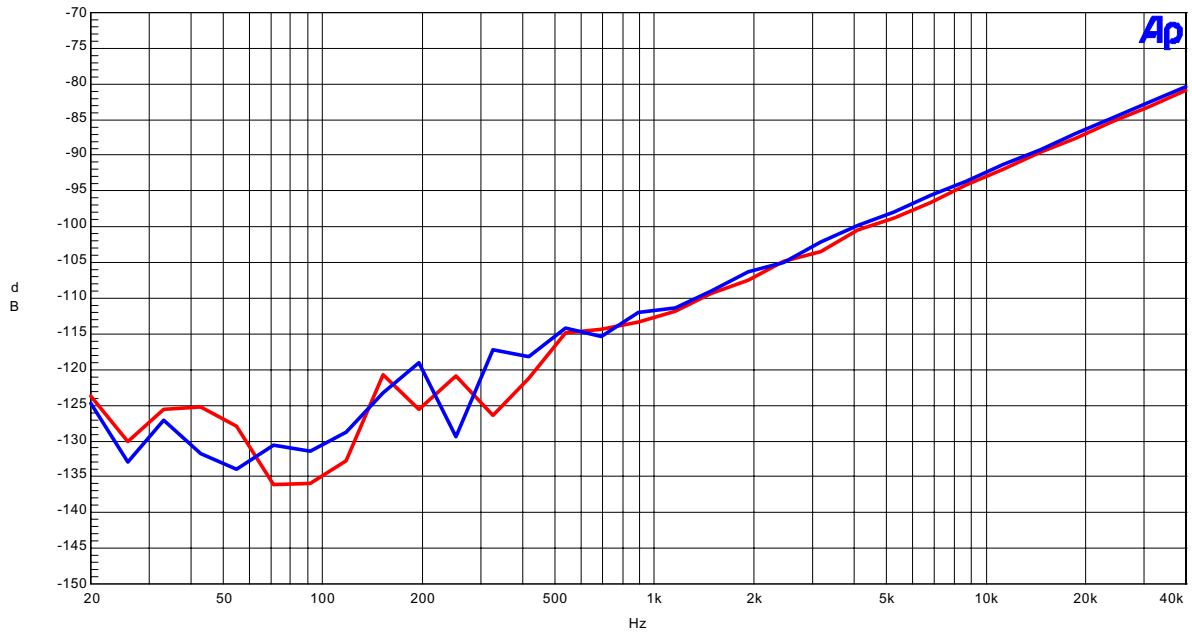

Figure 13. Crosstalk

AK5365 FFT Plot  
AVDD=5.0V, DVDD=3.3V, fs=96kHz, Input=-0.5dBr, fin=1kHz

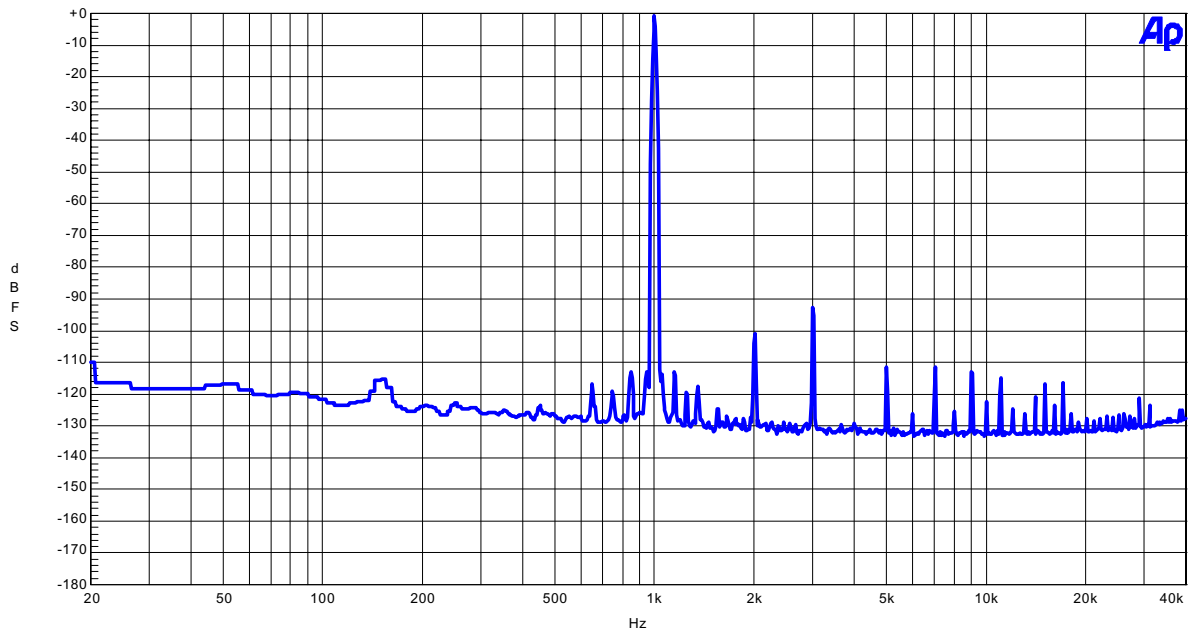

Figure 14. FFT Plot



AK5365 FFT Plot  
AVDD=5.0V, DVDD=3.3V, fs=96kHz, Input=-60dB, fin=1kHz

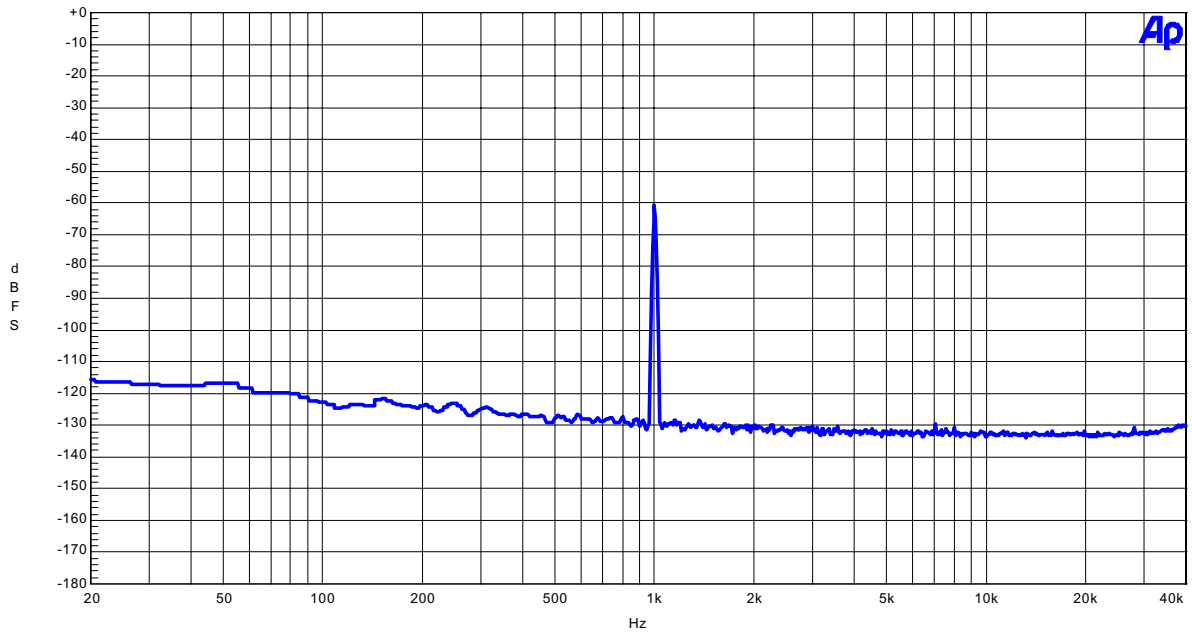

Figure 15. FFT Plot

AK5365 FFT Plot  
AVDD=5.0V, DVDD=3.3V, fs=96kHz, fin=None

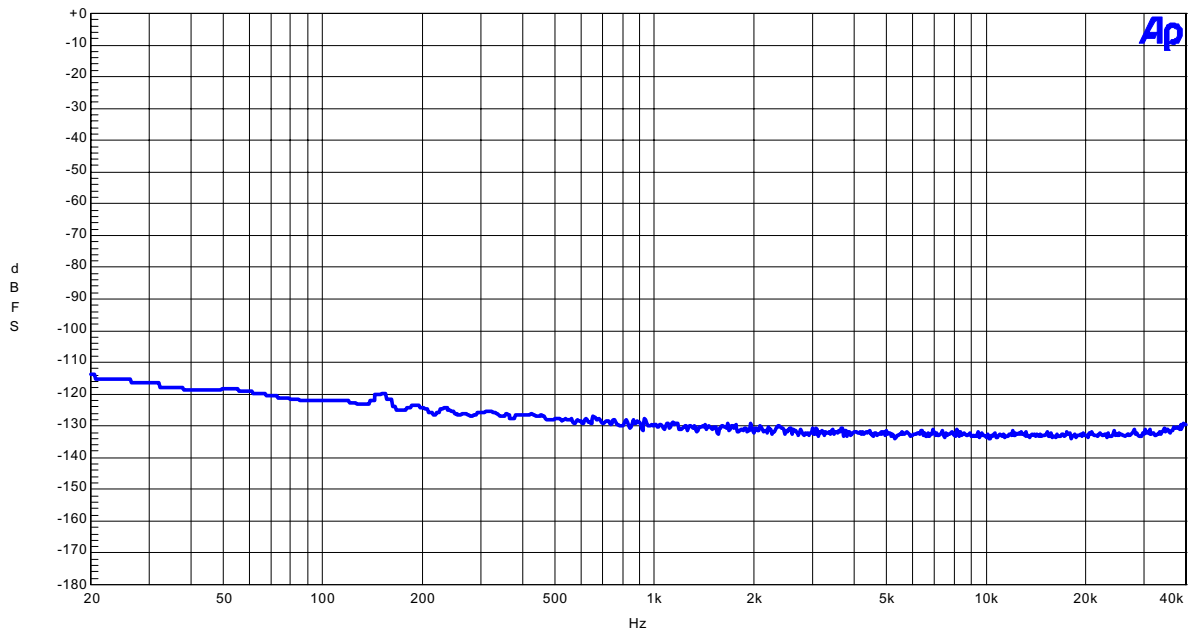
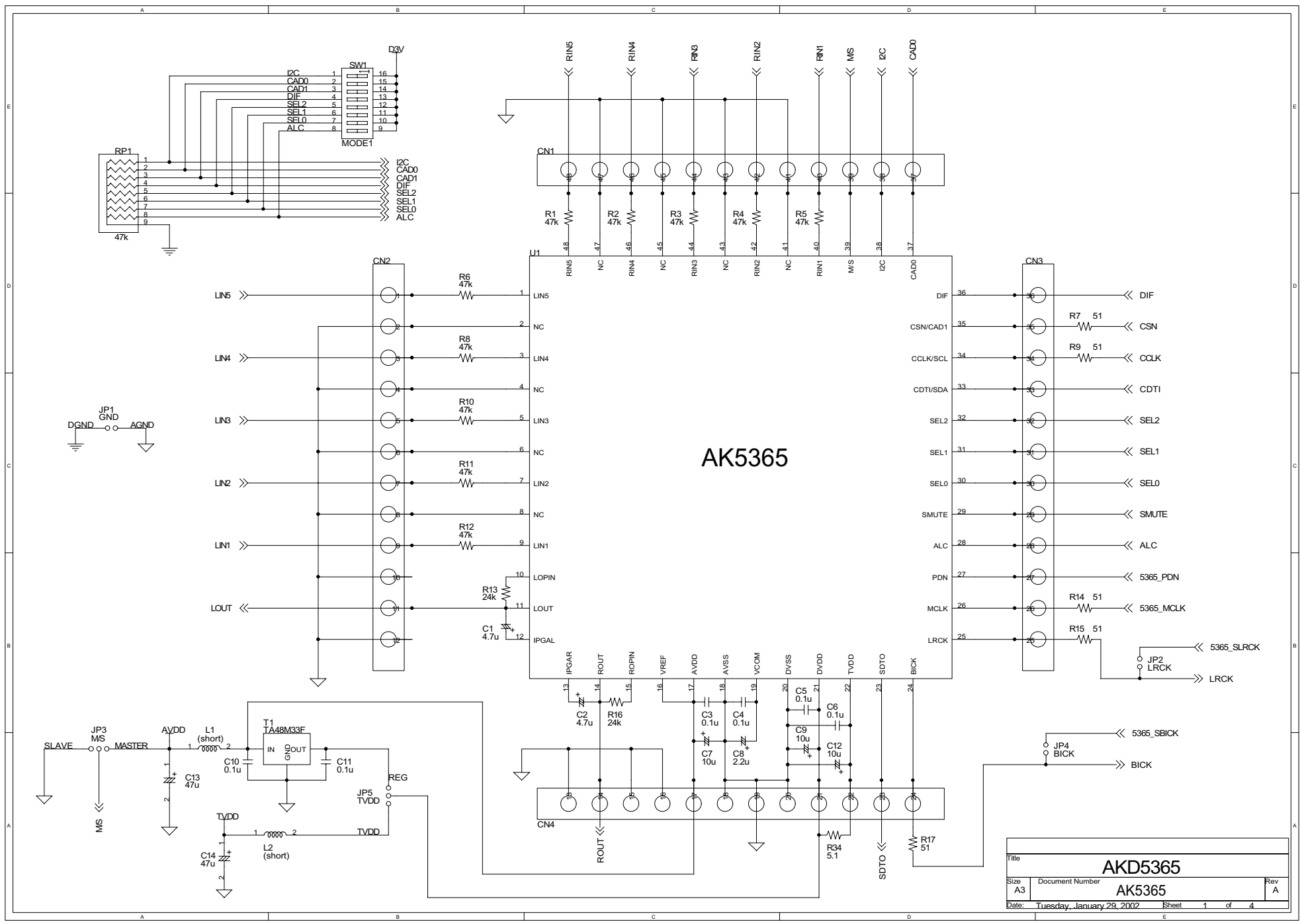

Figure 16. FFT Plot

IMPORTANT NOTICE

- These products and their specifications are subject to change without notice. Before considering any use or application, consult the Asahi Kasei Microsystems Co., Ltd. (AKM) sales office or authorized distributor concerning their current status.
- AKM assumes no liability for infringement of any patent, intellectual property, or other right in the application or use of any information contained herein.
- Any export of these products, or devices or systems containing them, may require an export license or other official approval under the law and regulations of the country of export pertaining to customs and tariffs, currency exchange, or strategic materials.
- AKM products are neither intended nor authorized for use as critical components in any safety, life support, or other hazard related device or system, and AKM assumes no responsibility relating to any such use, except with the express written consent of the Representative Director of AKM. As used here:
  - (a) A hazard related device or system is one designed or intended for life support or maintenance of safety or for applications in medicine, aerospace, nuclear energy, or other fields, in which its failure to function or perform may reasonably be expected to result in loss of life or in significant injury or damage to person or property.
  - (b) A critical component is one whose failure to function or perform may reasonably be expected to result, whether directly or indirectly, in the loss of the safety or effectiveness of the device or system containing it, and which must therefore meet very high standards of performance and reliability.
- It is the responsibility of the buyer or distributor of an AKM product who distributes, disposes of, or otherwise places the product with a third party to notify that party in advance of the above content and conditions, and the buyer or distributor agrees to assume any and all responsibility and liability for and hold AKM harmless from any and all claims arising from the use of said product in the absence of such notification.





AK5365

Title			AKD5365		
Size	Document Number	AK5365			Rev
A3					A
Date:	Tuesday, January 29, 2002	Sheet	1	of	4



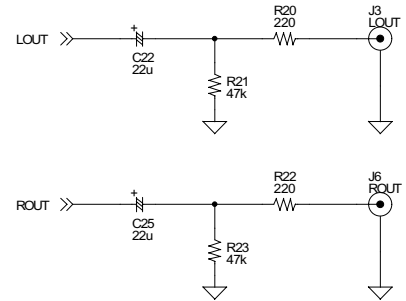
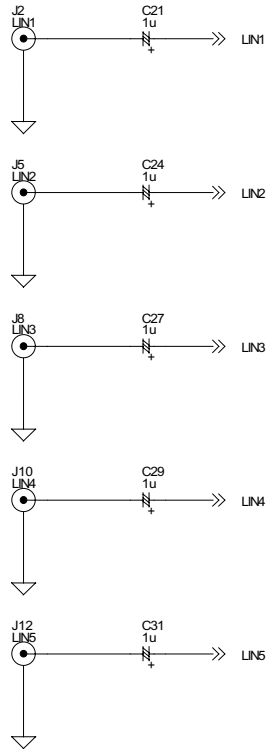
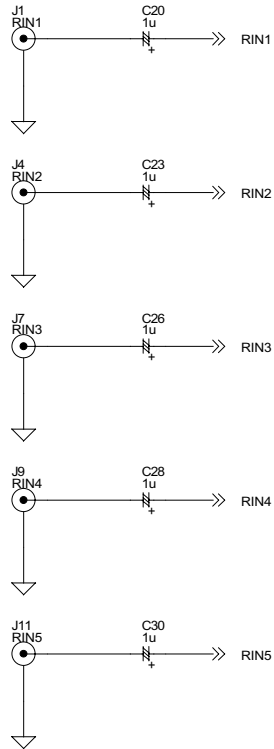

Title		AKD5365	
Size	Document Number	Input/Output	Rev
A3			A
Date: Tuesday, January 29, 2002		Sheet	3 of 4

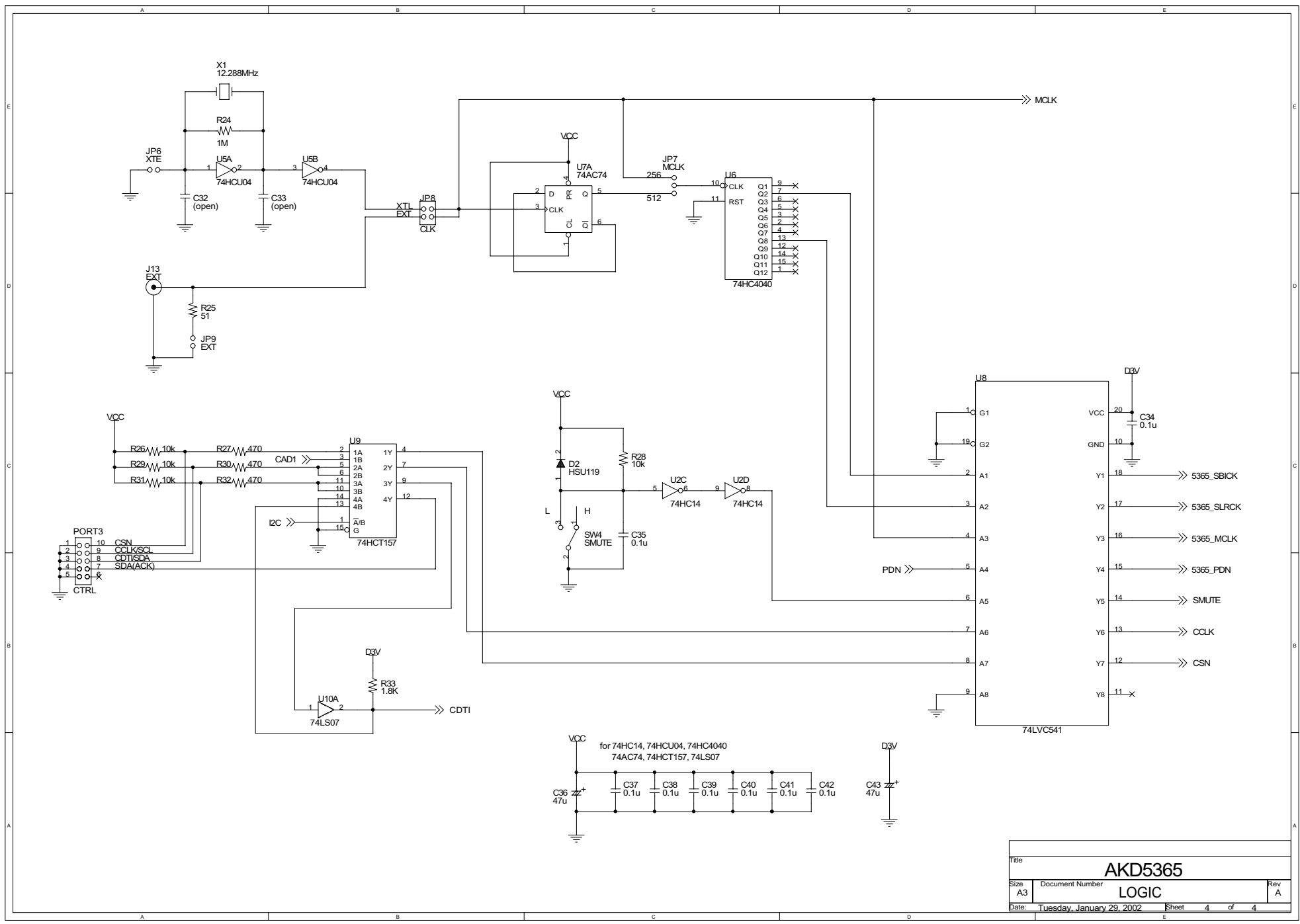

Title			
<b>AKD5365</b>			
Size	Document Number	LOGIC	
A3			Rev A
Date:	Tuesday, January 29, 2002	Sheet	4 of 4

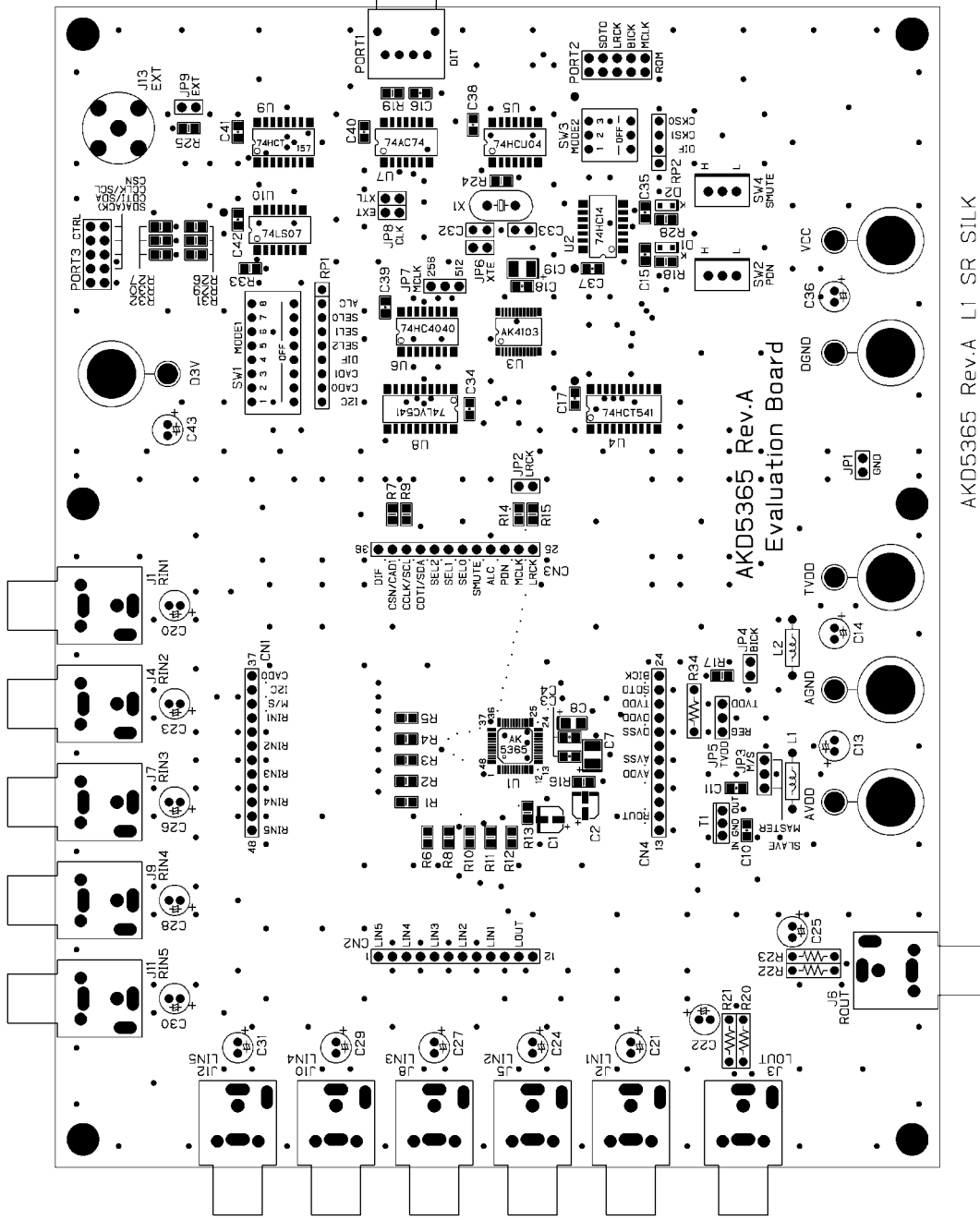

AKD5365 Rev.A  
Evaluation Board

AKD5365 Rev.A L1 SR SILK



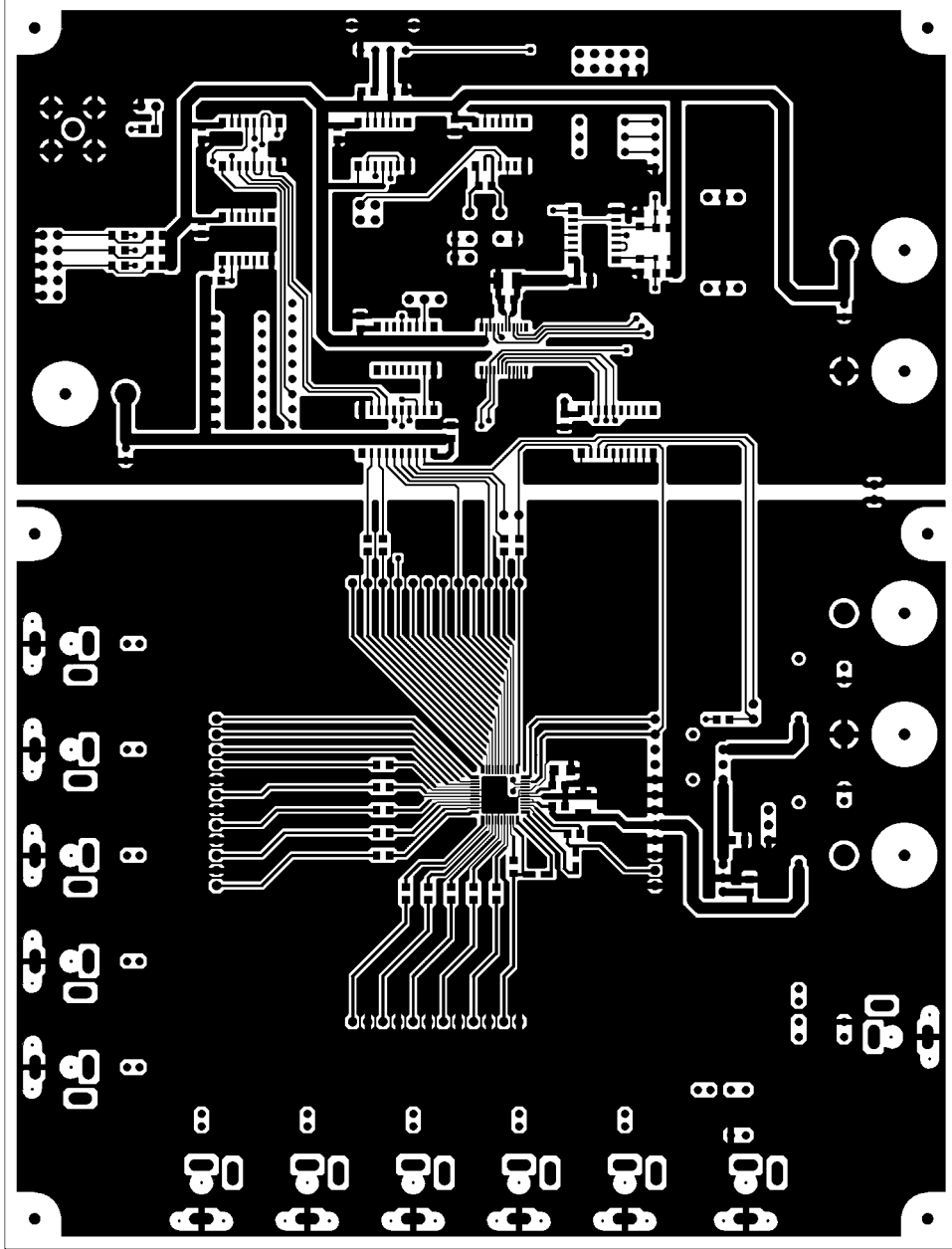

AKD5365 Rev.A L1

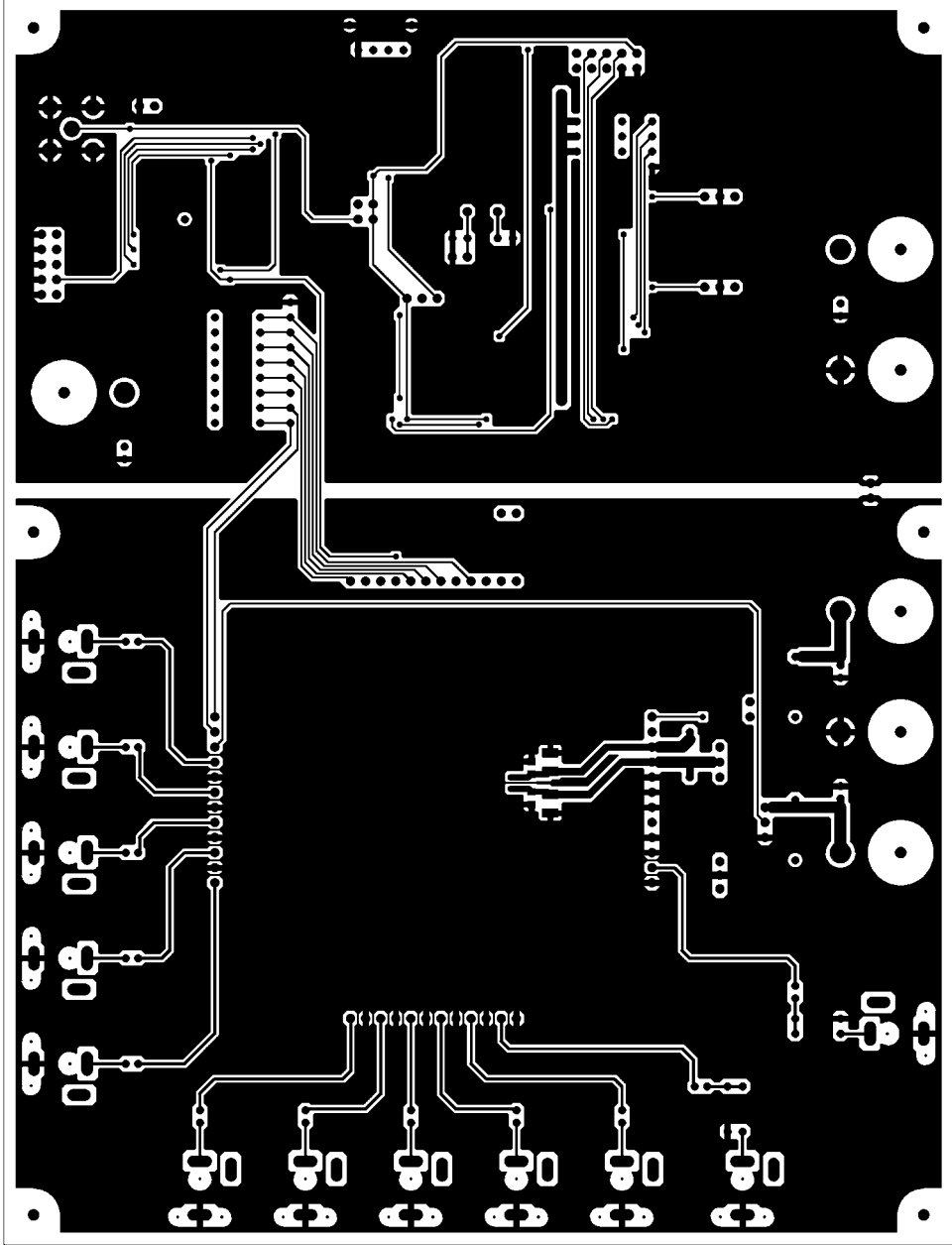

AKD2382 Rev.A FS

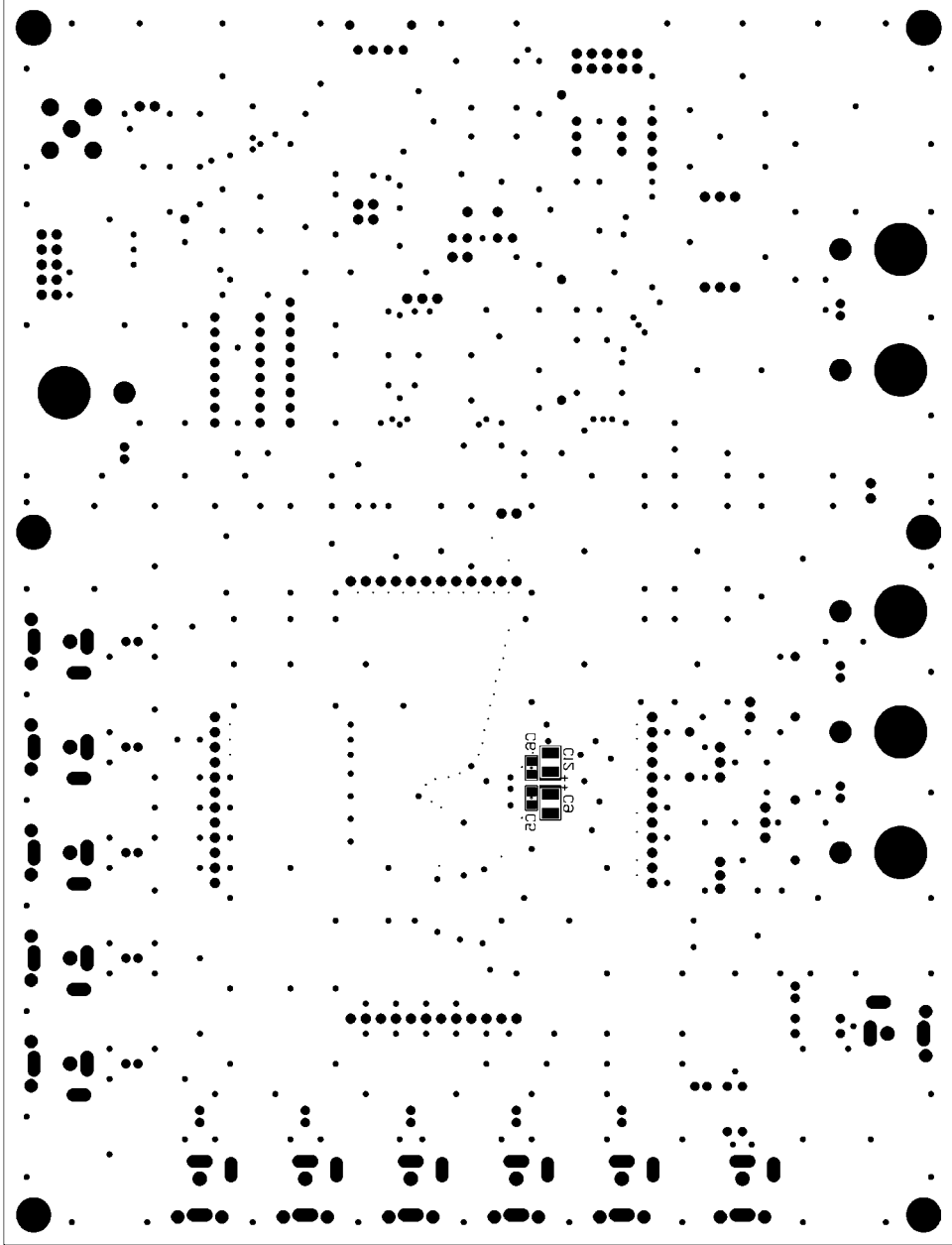

AKD23BP2 Res.V. TS 2R 2ITK