

## Triple phase leg MOSFET Power Module

$$V_{DSS} = 1200V$$

$$R_{DSon} = 570m\Omega \text{ typ @ } T_j = 25^\circ C$$

$$I_D = 17A \text{ @ } T_c = 25^\circ C$$

### Application

- Welding converters
- Switched Mode Power Supplies
- Uninterruptible Power Supplies
- Motor control

### Features

- Power MOS 7<sup>®</sup> FREDFETs
  - Low  $R_{DSon}$
  - Low input and Miller capacitance
  - Low gate charge
  - Fast intrinsic reverse diode
  - Avalanche energy rated
  - Very rugged
- Kelvin source for easy drive
- Very low stray inductance
  - Symmetrical design
  - Lead frames for power connections
- High level of integration

### Benefits

- Outstanding performance at high frequency operation
- Direct mounting to heatsink (isolated package)
- Low junction to case thermal resistance
- Solderable terminals both for power and signal for easy PCB mounting
- Very low (12mm) profile
- Each leg can be easily paralleled to achieve a phase leg of three times the current capability
- Module can be configured as a three phase bridge
- Module can be configured as a boost followed by a full bridge
- RoHS Compliant

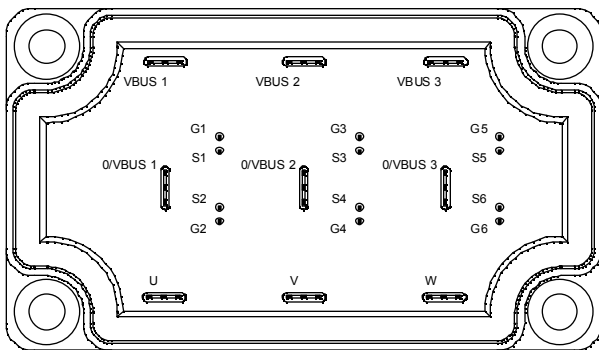
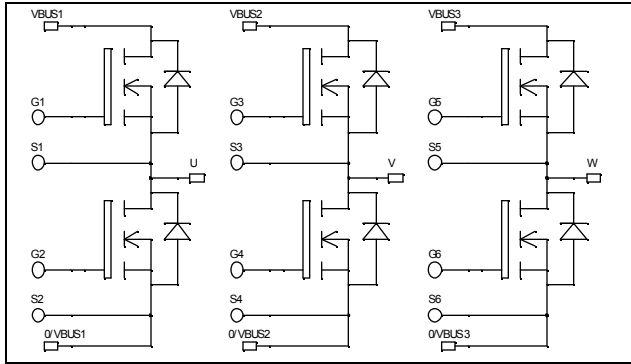

### Absolute maximum ratings

Symbol	Parameter	Max ratings	Unit
$V_{DSS}$	Drain - Source Breakdown Voltage	1200	V
$I_D$	Continuous Drain Current	$T_c = 25^\circ C$	17
		$T_c = 80^\circ C$	13
$I_{DM}$	Pulsed Drain current	68	
$V_{GS}$	Gate - Source Voltage	$\pm 30$	V
$R_{DSon}$	Drain - Source ON Resistance	684	$m\Omega$
$P_D$	Maximum Power Dissipation	$T_c = 25^\circ C$	390
$I_{AR}$	Avalanche current (repetitive and non repetitive)	22	A
$E_{AR}$	Repetitive Avalanche Energy	50	mJ
$E_{AS}$	Single Pulse Avalanche Energy	3000	

**CAUTION:** These Devices are sensitive to Electrostatic Discharge. Proper Handling Procedures Should Be Followed. See application note APT0502 on [www.microsemi.com](http://www.microsemi.com)

All ratings @  $T_j = 25^\circ\text{C}$  unless otherwise specified

**Electrical Characteristics**

Symbol	Characteristic	Test Conditions	Min	Typ	Max	Unit
$I_{DSS}$	Zero Gate Voltage Drain Current	$V_{GS} = 0\text{V}, V_{DS} = 1200\text{V}$			250	$\mu\text{A}$
		$V_{GS} = 0\text{V}, V_{DS} = 1000\text{V}$	$T_j = 125^\circ\text{C}$		1000	
$R_{DS(on)}$	Drain – Source on Resistance	$V_{GS} = 10\text{V}, I_D = 8.5\text{A}$		570	684	$\text{m}\Omega$
$V_{GS(th)}$	Gate Threshold Voltage	$V_{GS} = V_{DS}, I_D = 2.5\text{mA}$	3		5	V
$I_{GSS}$	Gate – Source Leakage Current	$V_{GS} = \pm 30\text{V}, V_{DS} = 0\text{V}$			$\pm 100$	nA

**Dynamic Characteristics**

Symbol	Characteristic	Test Conditions	Min	Typ	Max	Unit
$C_{iss}$	Input Capacitance	$V_{GS} = 0\text{V}$		5155		pF
$C_{oss}$	Output Capacitance	$V_{DS} = 25\text{V}$		770		
$C_{rss}$	Reverse Transfer Capacitance	$f = 1\text{MHz}$		130		
$Q_g$	Total gate Charge	$V_{GS} = 10\text{V}$		187		nC
$Q_{gs}$	Gate – Source Charge	$V_{Bus} = 600\text{V}$		24		
$Q_{gd}$	Gate – Drain Charge	$I_D = 17\text{A}$		120		
$T_{d(on)}$	Turn-on Delay Time	<b>Inductive switching @ <math>125^\circ\text{C}</math></b>		20		ns
$T_r$	Rise Time	$V_{GS} = 15\text{V}$		15		
$T_{d(off)}$	Turn-off Delay Time	$V_{Bus} = 800\text{V}$		160		
$T_f$	Fall Time	$I_D = 17\text{A}$ $R_G = 5\Omega$		45		
$E_{on}$	Turn-on Switching Energy	<b>Inductive switching @ <math>25^\circ\text{C}</math></b>		990		$\mu\text{J}$
$E_{off}$	Turn-off Switching Energy	$V_{GS} = 15\text{V}, V_{Bus} = 800\text{V}$ $I_D = 17\text{A}, R_G = 5\Omega$		685		
$E_{on}$	Turn-on Switching Energy	<b>Inductive switching @ <math>125^\circ\text{C}</math></b>		1565		$\mu\text{J}$
$E_{off}$	Turn-off Switching Energy	$V_{GS} = 15\text{V}, V_{Bus} = 800\text{V}$ $I_D = 17\text{A}, R_G = 5\Omega$		857		

**Source - Drain diode ratings and characteristics**

Symbol	Characteristic	Test Conditions	Min	Typ	Max	Unit	
$I_S$	Continuous Source current (Body diode)	$T_c = 25^\circ\text{C}$			17	A	
		$T_c = 80^\circ\text{C}$			13		
$V_{SD}$	Diode Forward Voltage	$V_{GS} = 0\text{V}, I_S = -17\text{A}$			1.3	V	
$dv/dt$	Peak Diode Recovery ①				18	V/ns	
$t_{rr}$	Reverse Recovery Time	$I_S = -17\text{A}$ $V_R = 600\text{V}$ $di/dt = 100\text{A}/\mu\text{s}$	$T_j = 25^\circ\text{C}$			320	ns
			$T_j = 125^\circ\text{C}$			650	
$Q_{rr}$	Reverse Recovery Charge	$I_S = -17\text{A}$ $V_R = 600\text{V}$ $di/dt = 100\text{A}/\mu\text{s}$	$T_j = 25^\circ\text{C}$		2	$\mu\text{C}$	
			$T_j = 125^\circ\text{C}$		7		

 ①  $dv/dt$  numbers reflect the limitations of the circuit rather than the device itself.

$$I_S \leq -17\text{A} \quad di/dt \leq 700\text{A}/\mu\text{s} \quad V_R \leq V_{DSS} \quad T_j \leq 150^\circ\text{C}$$

## Thermal and package characteristics

*Symbol Characteristic*

		<i>Min</i>	<i>Typ</i>	<i>Max</i>	<i>Unit</i>	
$R_{thJC}$	Junction to Case Thermal Resistance			0.32	°C/W	
$V_{ISOL}$	RMS Isolation Voltage, any terminal to case t=1 min, I isol<1mA, 50/60Hz	2500			V	
$T_J$	Operating junction temperature range	-40		150	°C	
$T_{STG}$	Storage Temperature Range	-40		125		
$T_C$	Operating Case Temperature	-40		100		
Torque	Mounting torque	To heatsink	M6	3	5	N.m
Wt	Package Weight				250	g

## SP6-P Package outline (dimensions in mm)

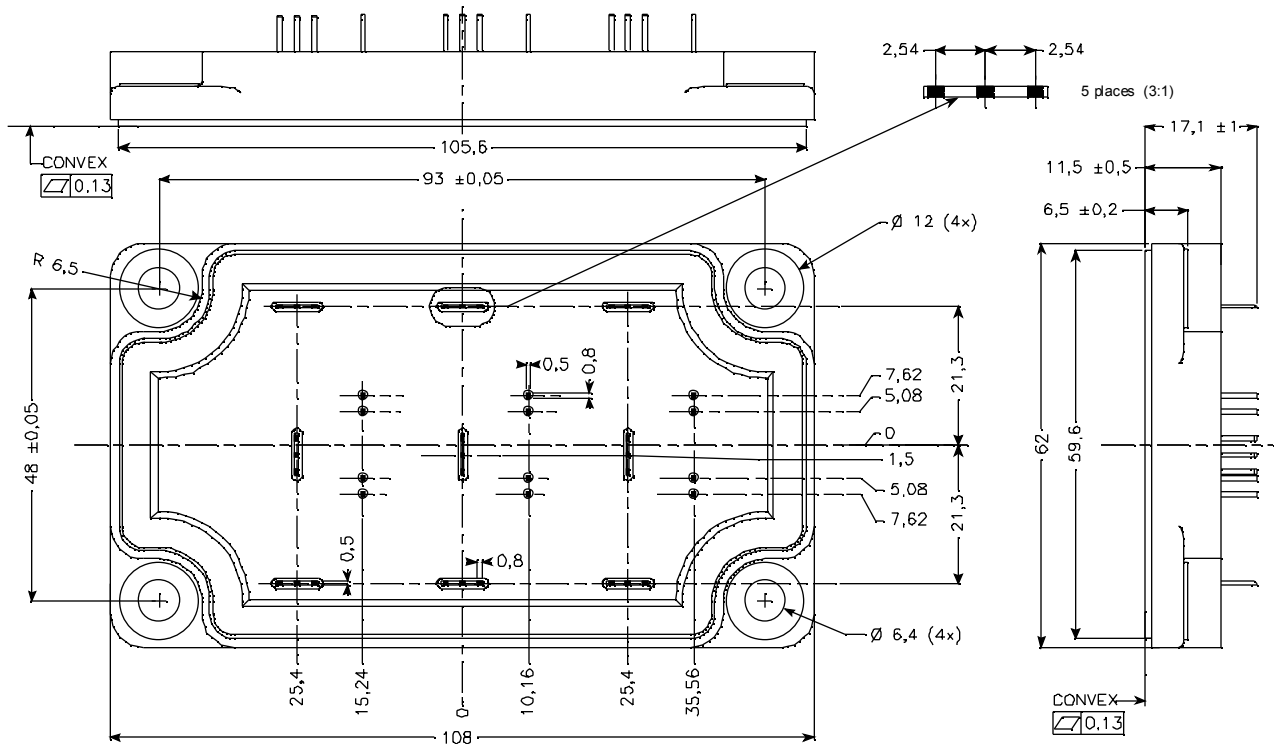

See application note 1902 - Mounting Instructions for SP6-P (12mm) Power Modules on [www.microsemi.com](http://www.microsemi.com)

## Typical Performance Curve

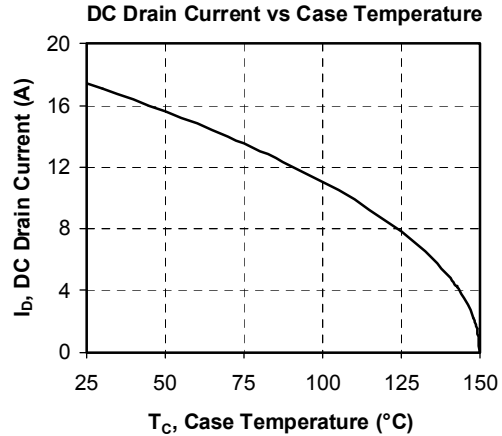
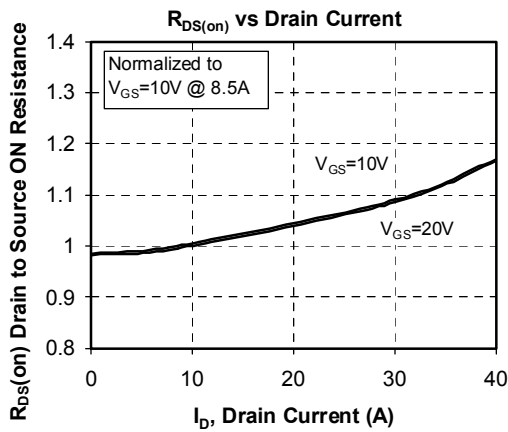
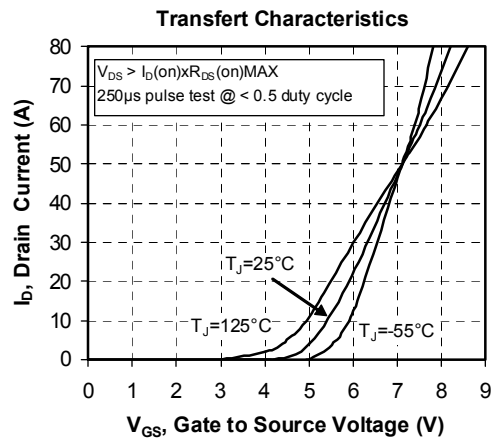
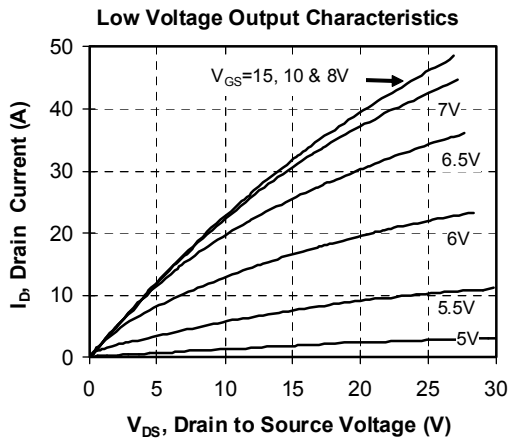
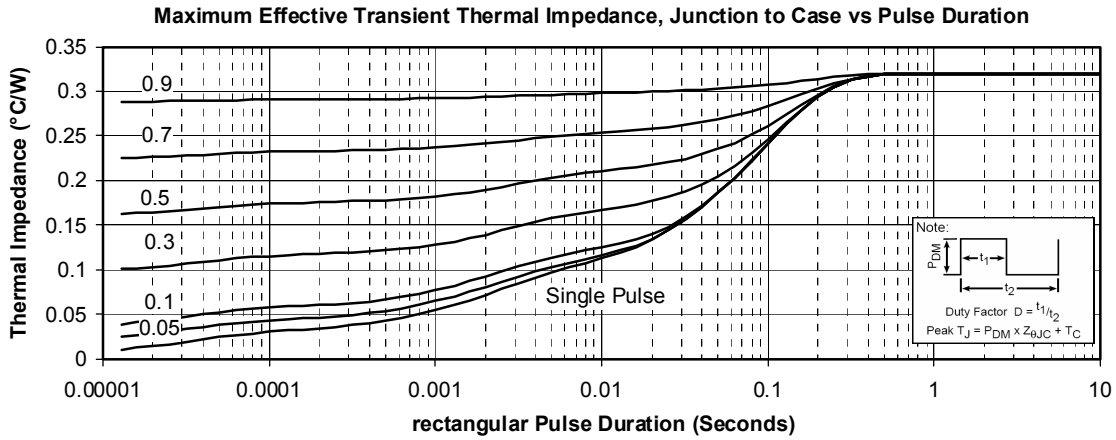

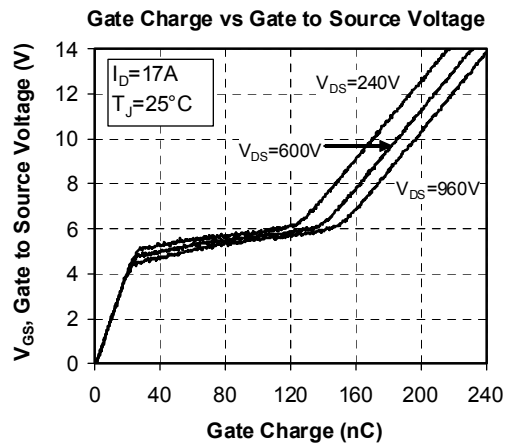
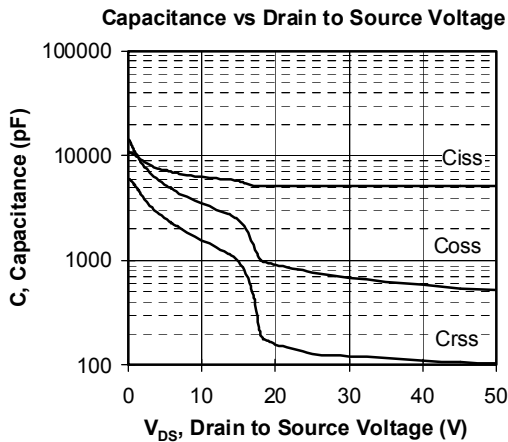
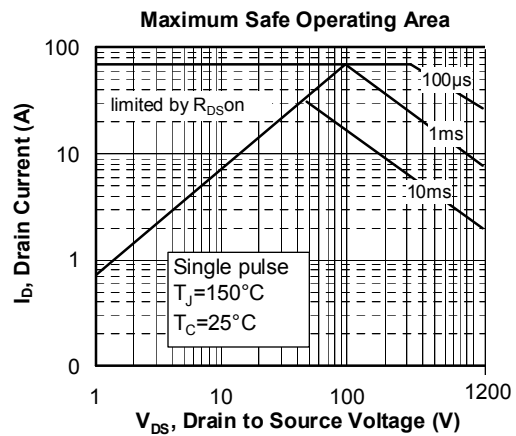
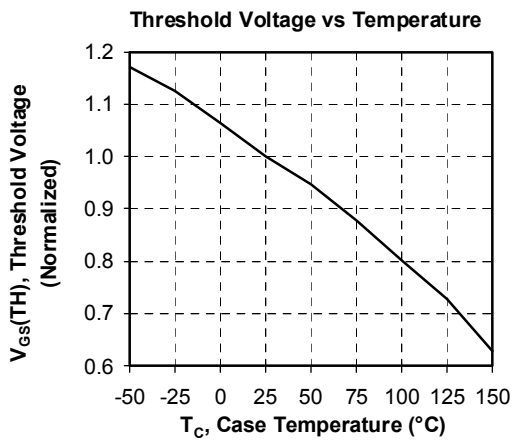
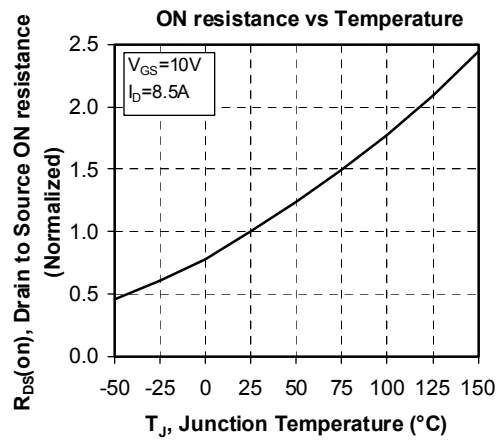
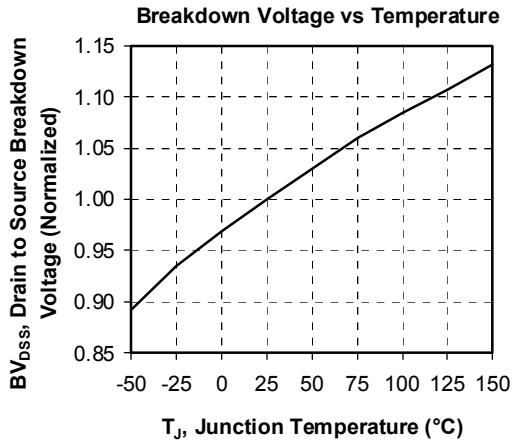

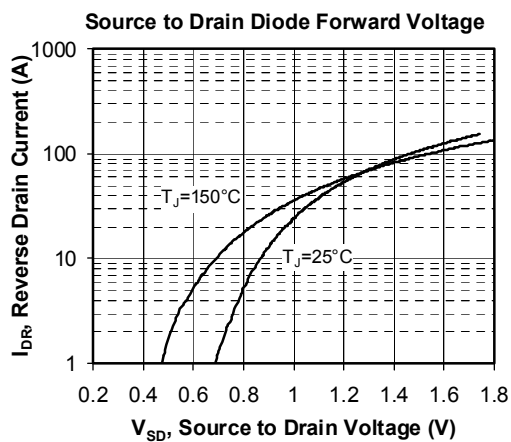
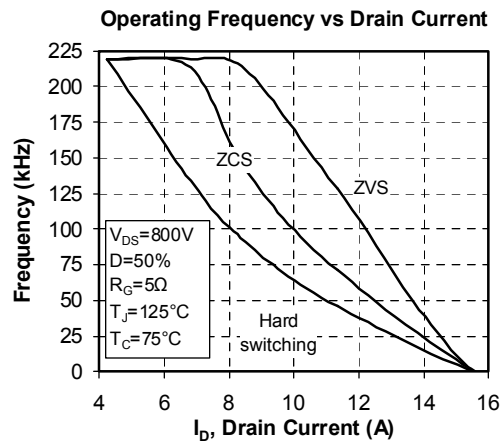
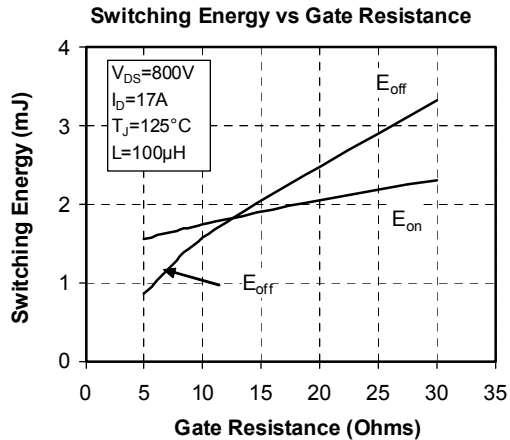
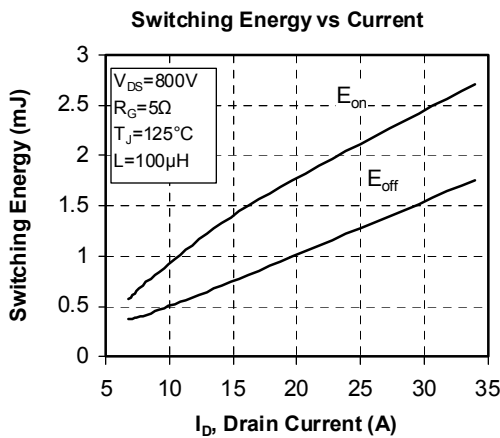
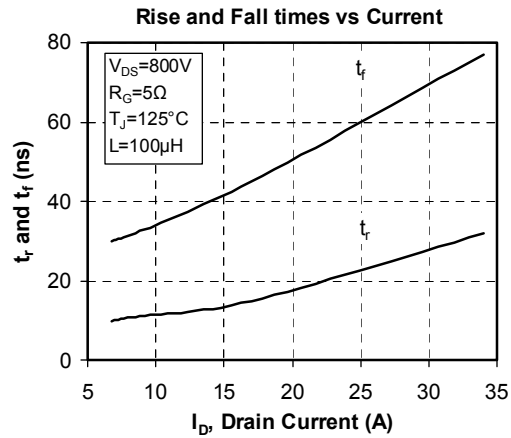
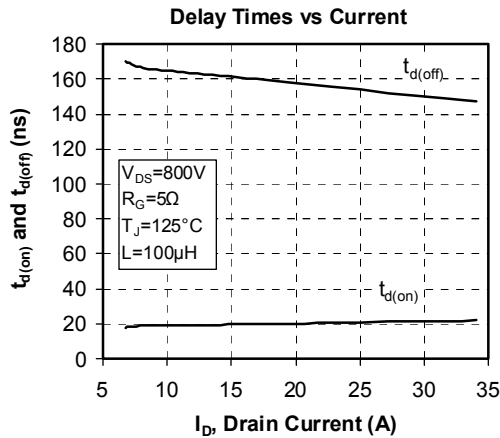

Microsemi reserves the right to change, without notice, the specifications and information contained herein

Microsemi's products are covered by one or more of U.S. patents 4,895,810 5,045,903 5,089,434 5,182,234 5,019,522 5,262,336 6,503,786 5,256,583 4,748,103 5,283,202 5,231,474 5,434,095 5,528,058 and foreign patents. U.S. and Foreign patents pending. All Rights Reserved.