

**Single switch
MOSFET Power Module**

**$V_{DSS} = 1200V$
 $R_{DSon} = 70m\Omega \text{ max @ } T_j = 25^\circ C$
 $I_D = 171A \text{ @ } T_c = 25^\circ C$**

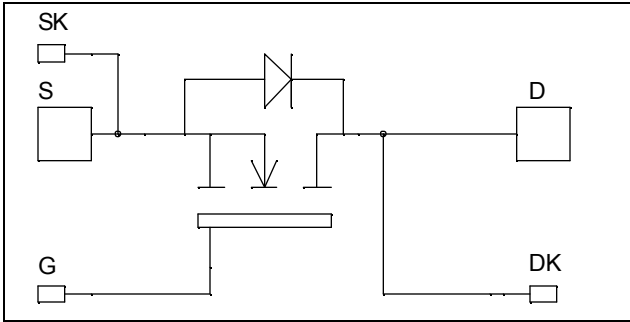

Application

- Welding converters
- Switched Mode Power Supplies
- Uninterruptible Power Supplies
- Motor control

Features

- Power MOS 7® FREDFETs
 - Low R_{DSon}
 - Low input and Miller capacitance
 - Low gate charge
 - Fast intrinsic reverse diode
 - Avalanche energy rated
 - Very rugged
- Kelvin source for easy drive
- Very low stray inductance
 - Symmetrical design
 - M5 power connectors
- High level of integration
- AlN substrate for improved thermal performance

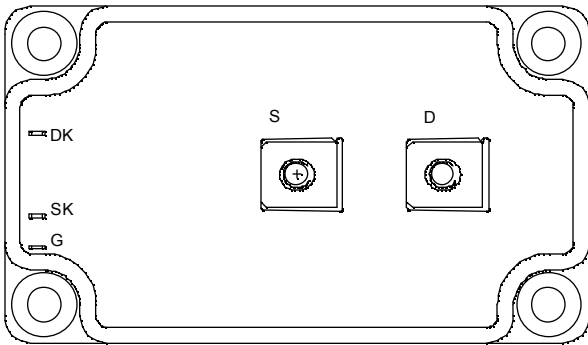

Benefits

- Outstanding performance at high frequency operation
- Direct mounting to heatsink (isolated package)
- Low junction to case thermal resistance
- Low profile

Absolute maximum ratings

Symbol	Parameter	Max ratings	Unit
V_{DSS}	Drain - Source Breakdown Voltage	1200	V
I_D	Continuous Drain Current	$T_c = 25^\circ C$	171
		$T_c = 80^\circ C$	126
I_{DM}	Pulsed Drain current	684	A
V_{GS}	Gate - Source Voltage	± 30	V
R_{DSon}	Drain - Source ON Resistance	70	$m\Omega$
P_D	Maximum Power Dissipation	$T_c = 25^\circ C$	5000
I_{AR}	Avalanche current (repetitive and non repetitive)	24	A
E_{AR}	Repetitive Avalanche Energy	50	mJ
E_{AS}	Single Pulse Avalanche Energy	3200	

CAUTION: These Devices are sensitive to Electrostatic Discharge. Proper Handling Procedures Should Be Followed.

All ratings @ $T_j = 25^\circ\text{C}$ unless otherwise specified

Electrical Characteristics

Symbol	Characteristic	Test Conditions	Min	Typ	Max	Unit
BV_{DSS}	Drain - Source Breakdown Voltage	$V_{GS} = 0V, I_D = 1.5mA$	1200			V
I_{DSS}	Zero Gate Voltage Drain Current	$V_{GS} = 0V, V_{DS} = 1200V, T_j = 25^\circ\text{C}$			1.5	mA
		$V_{GS} = 0V, V_{DS} = 1000V, T_j = 125^\circ\text{C}$			6	
$R_{DS(on)}$	Drain - Source on Resistance	$V_{GS} = 10V, I_D = 85.5A$			70	m Ω
$V_{GS(th)}$	Gate Threshold Voltage	$V_{GS} = V_{DS}, I_D = 30mA$	3		5	V
I_{GSS}	Gate - Source Leakage Current	$V_{GS} = \pm 30V, V_{DS} = 0V$			± 600	nA

Dynamic Characteristics

Symbol	Characteristic	Test Conditions	Min	Typ	Max	Unit
C_{iss}	Input Capacitance	$V_{GS} = 0V, V_{DS} = 25V, f = 1MHz$		43.5		nF
C_{oss}	Output Capacitance			6.6		
C_{rss}	Reverse Transfer Capacitance			1.2		
Q_g	Total gate Charge	$V_{GS} = 10V, V_{Bus} = 600V, I_D = 171A$		1650		nC
Q_{gs}	Gate - Source Charge			192		
Q_{gd}	Gate - Drain Charge			1074		
$T_{d(on)}$	Turn-on Delay Time	Inductive switching @ 125°C $V_{GS} = 15V, V_{Bus} = 800V, I_D = 171A, R_G = 0.8\Omega$		20		ns
T_r	Rise Time			17		
$T_{d(off)}$	Turn-off Delay Time			245		
T_f	Fall Time			62		
E_{on}	Turn-on Switching Energy ①	Inductive switching @ 25°C $V_{GS} = 15V, V_{Bus} = 800V, I_D = 171A, R_G = 0.8\Omega$		7.6		mJ
E_{off}	Turn-off Switching Energy ②			6.9		
E_{on}	Turn-on Switching Energy ①	Inductive switching @ 125°C $V_{GS} = 15V, V_{Bus} = 800V, I_D = 171A, R_G = 0.8\Omega$		13.8		mJ
E_{off}	Turn-off Switching Energy ②			8.5		

Source - Drain diode ratings and characteristics

Symbol	Characteristic	Test Conditions	Min	Typ	Max	Unit
I_S	Continuous Source current (Body diode)	$T_c = 25^\circ\text{C}$			171	A
		$T_c = 80^\circ\text{C}$			126	
V_{SD}	Diode Forward Voltage	$V_{GS} = 0V, I_S = -171A$			1.3	V
dv/dt	Peak Diode Recovery ③				18	V/ns
t_{rr}	Reverse Recovery Time	$I_S = -171A, V_R = 600V, di_s/dt = 600A/\mu s$	$T_j = 25^\circ\text{C}$		375	ns
			$T_j = 125^\circ\text{C}$		860	
Q_{rr}	Reverse Recovery Charge	$I_S = -171A, V_R = 600V, di_s/dt = 600A/\mu s$	$T_j = 25^\circ\text{C}$	12		μC
			$T_j = 125^\circ\text{C}$	54		

① E_{on} includes diode reverse recovery.

② In accordance with JEDEC standard JESD24-1.

③ dv/dt numbers reflect the limitations of the circuit rather than the device itself.

$$I_S \leq -171A \quad di/dt \leq 700A/\mu s \quad V_R \leq V_{DSS} \quad T_j \leq 150^\circ\text{C}$$

Thermal and package characteristics

Symbol	Characteristic		Min	Typ	Max	Unit
R _{thJC}	Junction to Case	Transistor			0.025	°C/W
V _{ISOL}	RMS Isolation Voltage, any terminal to case t=1 min, I _{isol} <1mA, 50/60Hz		2500			V
T _J	Operating junction temperature range		-40		150	°C
T _{STG}	Storage Temperature Range		-40		125	
T _C	Operating Case Temperature		-40		100	
Torque	Mounting torque	To heatsink	M6	3	5	N.m
		For terminals	M5	2	3.5	
Wt	Package Weight				280	g

Package outline

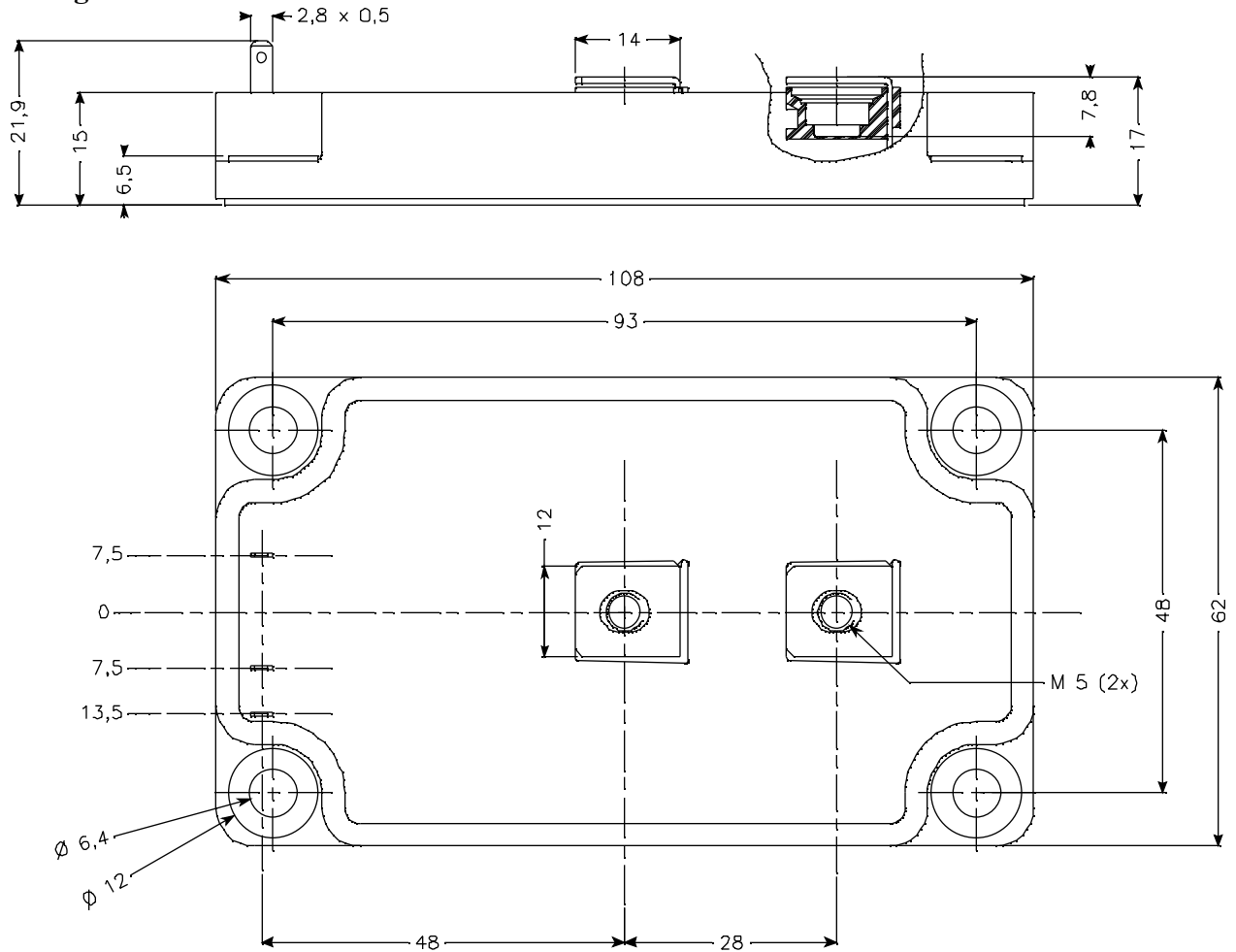

Typical Performance Curve

Maximum Effective Transient Thermal Impedance, Junction to Case vs Pulse Duration

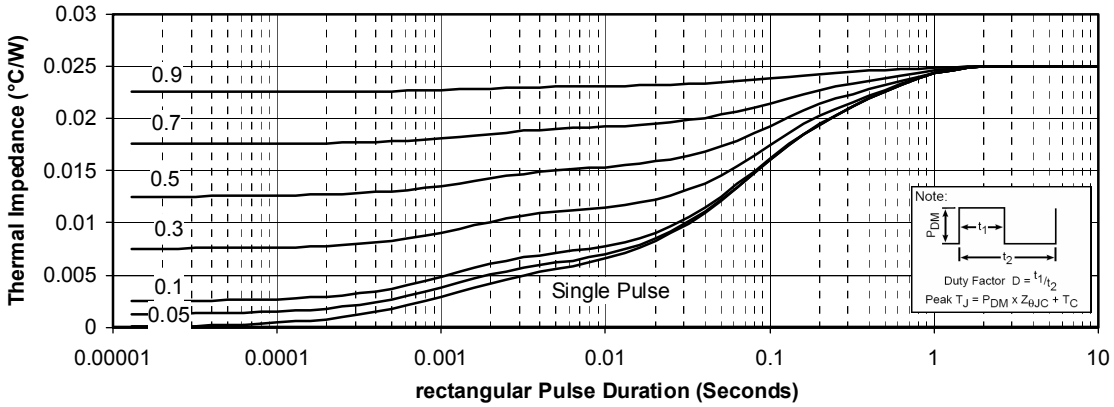

Low Voltage Output Characteristics

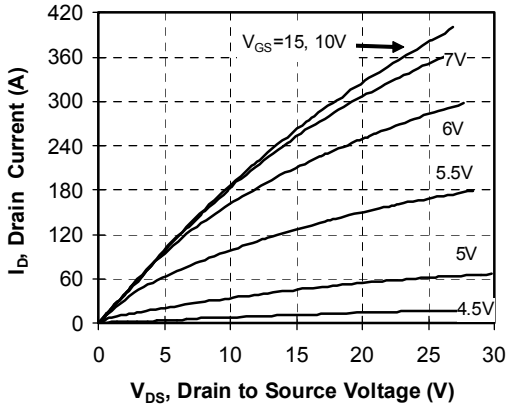

Transfer Characteristics

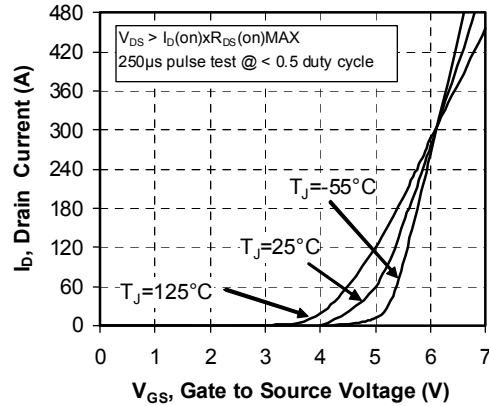

R_DS(on) vs Drain Current

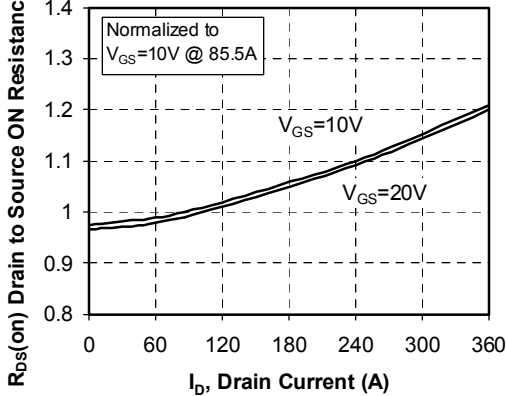

DC Drain Current vs Case Temperature

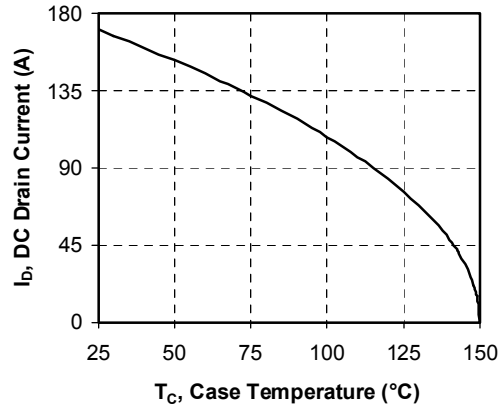

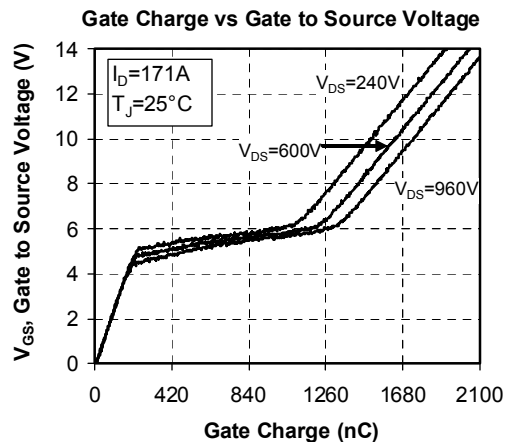
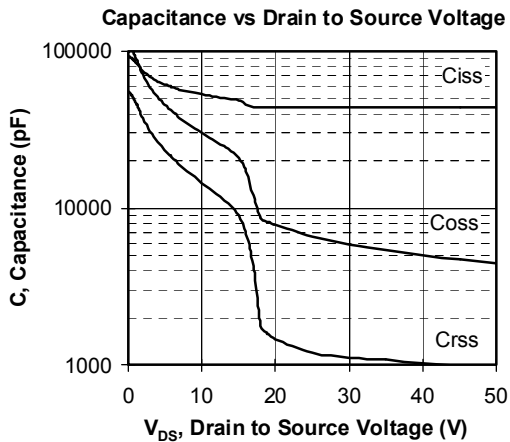
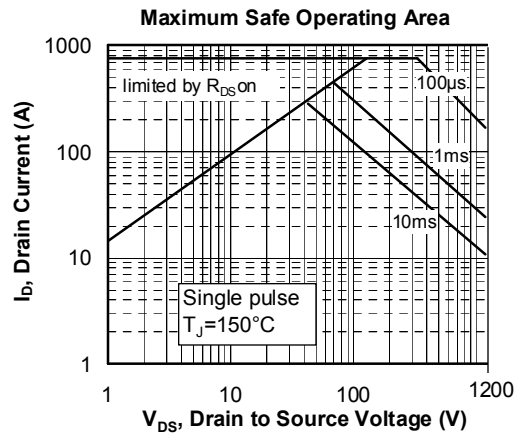
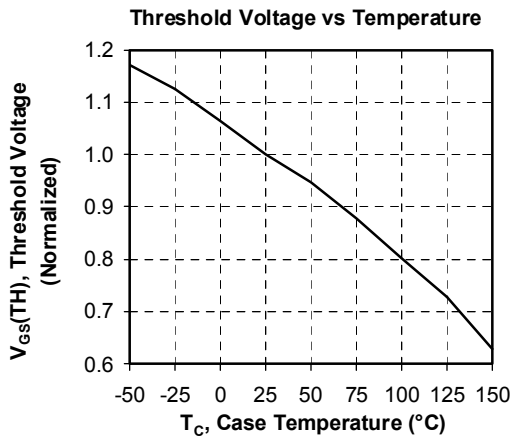
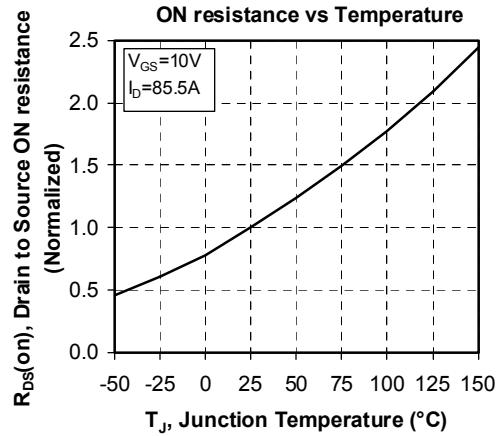
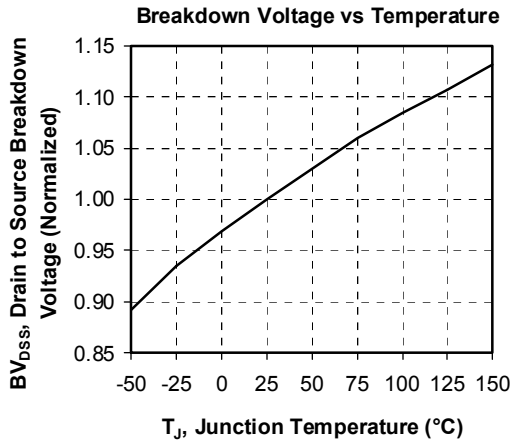

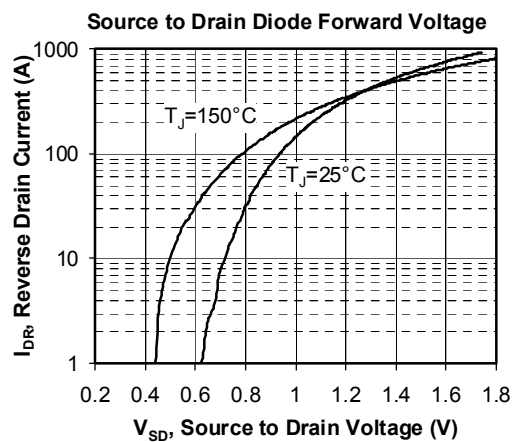
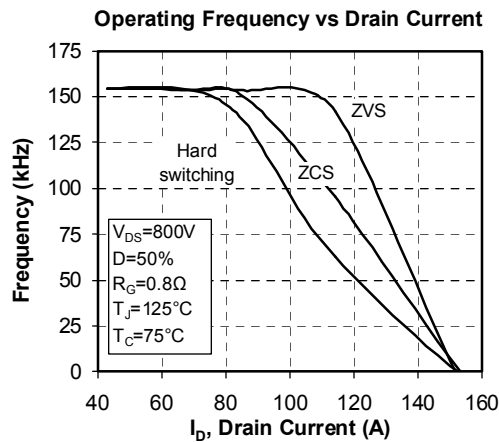
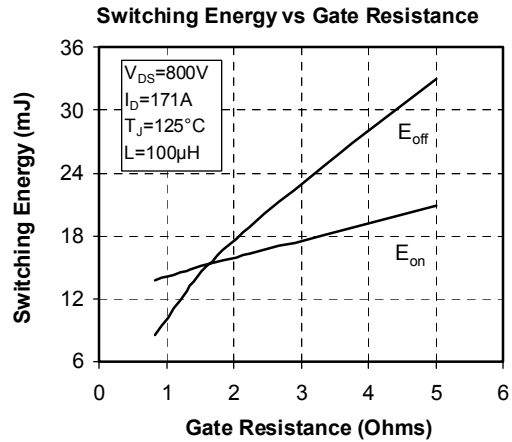
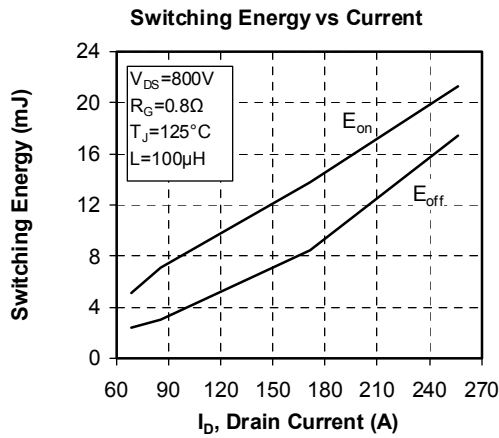
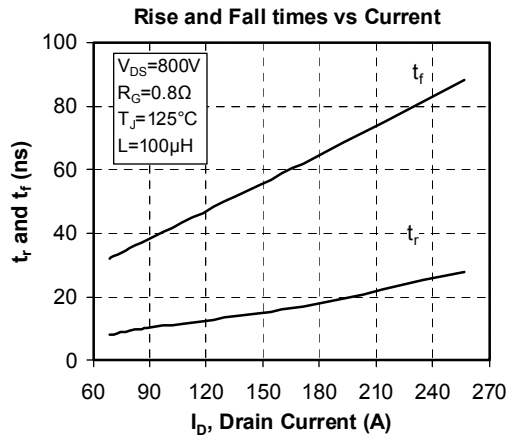
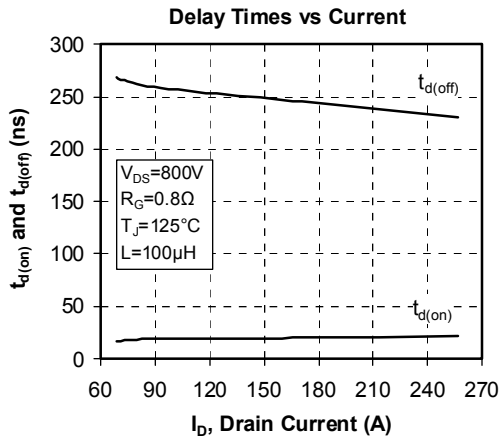

APT reserves the right to change, without notice, the specifications and information contained herein

APT's products are covered by one or more of U.S. patents 4,895,810 5,045,903 5,089,434 5,182,234 5,019,522 5,262,336 6,503,786 5,256,583 4,748,103 5,283,202 5,231,474 5,434,095 5,528,058 and foreign patents. U.S. and Foreign patents pending. All Rights Reserved.