

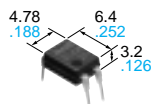

GU (General Use) Type 1-Channel (Form A) High Capacity 4-Pin Type

PhotoMOS RELAYS



mm inch

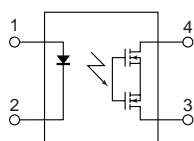

FEATURES

1. Greatly increased load current.
2. Reinforced insulation 5,000 V type.
3. Greatly improved specs allow you to use this in place of mercury and mechanical relays.
4. Compact 4-pin DIP size.

TYPICAL APPLICATIONS

- Security market
(use in I/O for alarm and security devices, etc.)
- Measuring instrument market

TYPES

| Type | I/O isolation voltage | Output rating* | | Part No. | | | | Packing quantity | |
|------------|-----------------------|----------------|--------------|-----------------------|-----------------------------|------------|------|------------------|------------|
| | | | | Through hole terminal | Surface-mount terminal | | | | |
| | | Load voltage | Load current | Tube packing style | Tape and reel packing style | | Tube | Tape and reel | |
| AC/DC type | Reinforced 5,000 V | 60 V | 1.1 A | AQY212GH | AQY212GHA | AQY212GHAX | | | AQY212GHAZ |

*Indicate the peak AC and DC values.

Note: For space reasons, the initial letters of the product number "AQY", the SMD terminal shape indicator "A" and the package type indicator "X" and "Z" are omitted from the seal.

RATING

1. Absolute maximum ratings (Ambient temperature: 25°C 77°F)

| Item | | Symbol | AQY212GH | Remarks |
|-------------------------|-----------------------------------|------------|---------------------------------|------------------------------------|
| Input | LED forward current | I_F | 50 mA | |
| | LED reverse voltage | V_R | 5 V | |
| | Peak forward current | I_{FP} | 1 A | f = 100 Hz, Duty factor = 0.1% |
| | Power dissipation | P_{in} | 75 mW | |
| Output | Load voltage (peak AC) | V_L | 60 V | |
| | Continuous load current (peak AC) | I_L | 1.1 A | |
| | Peak load current | I_{peak} | 3.0 A | 100ms (1 shot), $V_L = DC$ |
| | Power dissipation | P_{out} | 500 mW | |
| Total power dissipation | | P_T | 550 mW | |
| I/O isolation voltage | | V_{iso} | 5,000 V AC | |
| Temperature limits | Operating | T_{opr} | -40°C to +85°C -40°F to +185°F | Non-condensing at low temperatures |
| | Storage | T_{stg} | -40°C to +100°C -40°F to +212°F | |

AQY212GH

2. Electrical characteristics (Ambient temperature: 25°C 77°F)

| Item | | Symbol | AQY212GH | Condition | |
|----------------------------------|---------------------------|--|-------------------|---|----------------------------------|
| Input | LED operate current | Typical | 1.1 mA | $I_L = 100\text{mA}$ | |
| | | Maximum | 3 mA | | |
| | LED turn off current | Minimum | 0.3 mA | $I_L = 100\text{mA}$ | |
| | | Typical | 1.0 mA | | |
| LED dropout voltage | Typical | 1.14 V (1.32 V at $I_F = 50\text{ mA}$) | | $I_F = 5\text{ mA}$ | |
| | Maximum | 1.5 V | | | |
| Output | On resistance | Typical | 0.34 Ω | $I_F = 5\text{ mA}$ $I_L = \text{Max.}$ Within 1 s on time | |
| | | Maximum | 0.7 Ω | | |
| | Off state leakage current | Maximum | I_{Leak} | 1 μA | $I_F = 0$ $V_L = \text{Max.}$ |
| Transfer characteristics | Turn on time* | Typical | 1.3 ms | $I_F = 5\text{ mA}$ $I_L = 100\text{ mA}$ $V_L = 10\text{ V}$ | |
| | | Maximum | 5.0 ms | | |
| | Turn off time* | Typical | 0.1 ms | $I_F = 5\text{ mA}$ $I_L = 100\text{ mA}$ $V_L = 10\text{ V}$ | |
| | | Maximum | 0.5 ms | | |
| | I/O capacitance | Typical | C_{iso} | 0.8 pF | $f = 1\text{ MHz}$ $V_B = 0$ |
| | | Maximum | | 1.5 pF | |
| Initial I/O isolation resistance | Minimum | R_{iso} | 1,000 M Ω | 500 V DC | |

Note: Recommendable LED forward current $I_F = 5$ to 10 mA.

For type of connection, see Page 4.

*Turn on/Turn off time

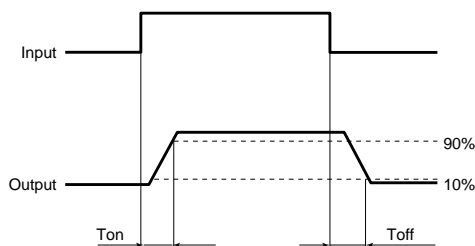

REFERENCE DATA

1. Load current vs. ambient temperature characteristics

Allowable ambient temperature: -40°C to $+85^\circ\text{C}$
 -40°F to $+185^\circ\text{F}$

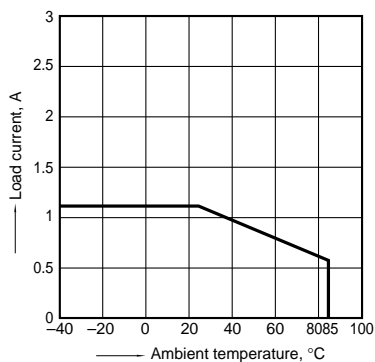

2. On resistance vs. ambient temperature characteristics

Measured portion: between terminals 3 and 4;
LED current: 5 mA; Load voltage: Max. (DC)
Continuous load current: Max. (DC)

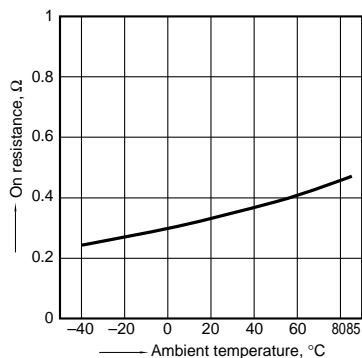

3. Turn on time vs. ambient temperature characteristics

LED current: 5 mA; Load voltage: 10 V (DC);
Continuous load current: 100 mA (DC)

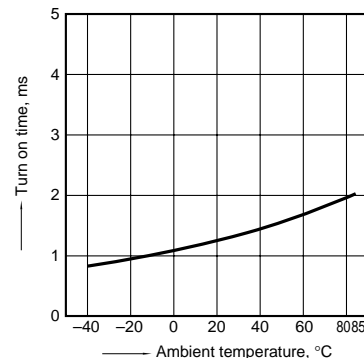

4. Turn off time vs. ambient temperature characteristics

LED current: 5 mA; Load voltage: 10 V (DC);
Continuous load current: 100 mA (DC)

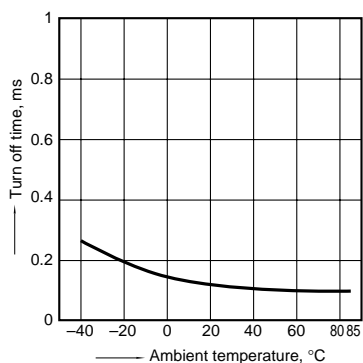

5. LED operate current vs. ambient temperature characteristics

Load voltage: 10 V (DC);
Continuous load current: 100mA (DC)

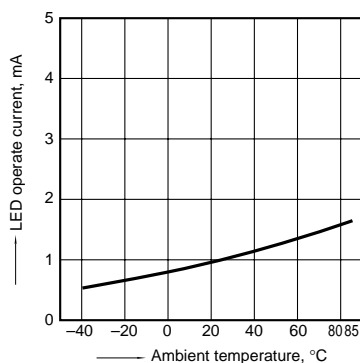

6. LED turn off current vs. ambient temperature characteristics

Load voltage: 10 V (DC);
Continuous load current: 100mA (DC)

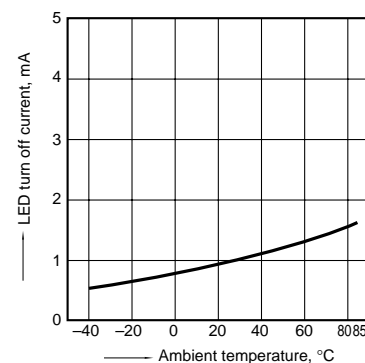

7. LED dropout voltage vs. ambient temperature characteristics

LED current: 5 to 50 mA

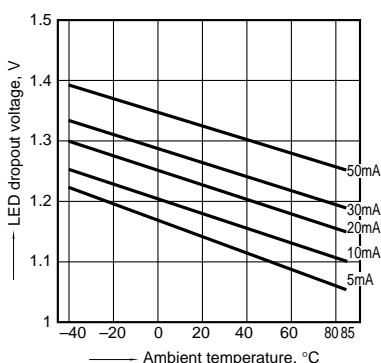

8. Voltage vs. current characteristics of output at MOS portion

Measured portion: between terminals 3 and 4;
Ambient temperature: 25°C 77°F

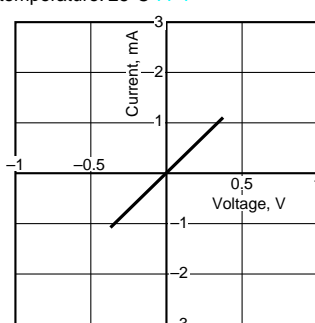

9. Off state leakage current

Measured portion: between terminals 3 and 4;
Ambient temperature: 25°C 77°F

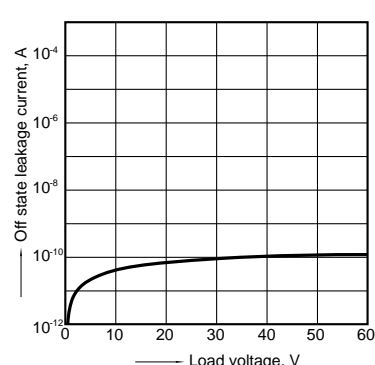

10. LED forward current vs. turn on time characteristics

Measured portion: between terminals 3 and 4;
Load voltage: 10 V (DC);
Continuous load current: 100 mA (DC);
Ambient temperature: 25°C 77°F

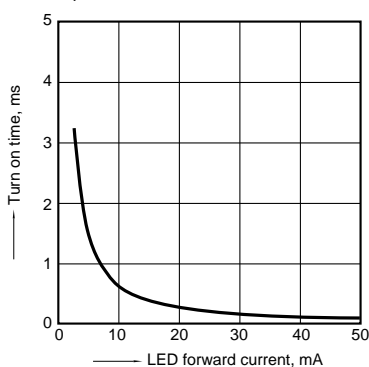

11. LED forward current vs. turn off time characteristics

Measured portion: between terminals 3 and 4;
Load voltage: 10 V (DC);
Continuous load current: 100 mA (DC);
Ambient temperature: 25°C 77°F

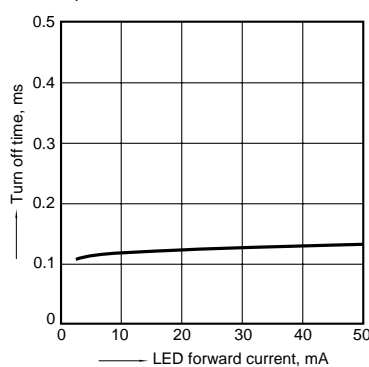

12. Applied voltage vs. output capacitance characteristics

Measured portion: between terminals 3 and 4;
Frequency: 1 MHz;
Ambient temperature: 25°C 77°F

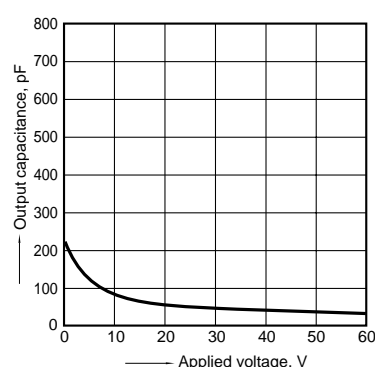

AQY212GH

DIMENSIONS

mm inch



Through hole terminal type

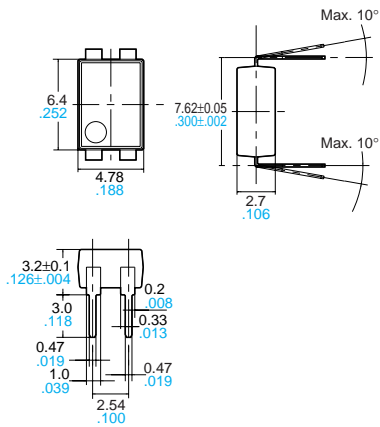

Terminal thickness = 0.2 .008
General tolerance: ±0.1 ±.004

Surface mount terminal type

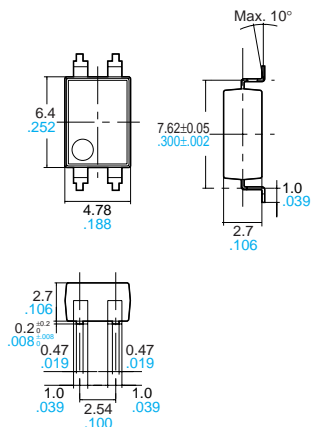

Terminal thickness = 0.2 .008
General tolerance: ±0.1 ±.004

PC board pattern (BOTTOM VIEW)

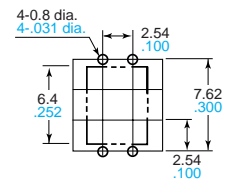

Tolerance: ±0.1 ±.004

Mounting pad (TOP VIEW)

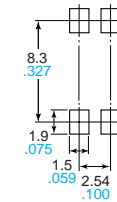

Tolerance: ±0.1 ±.004

SCHEMATIC AND WIRING DIAGRAMS

Notes: E₁: Power source at input side; I_F: LED forward current; V_L: Load voltage; I_L: Load current;

| Schematic | Output configuration | Load | Connection | Wiring diagram |
|-----------|----------------------|-------|------------|----------------|
| | 1a | AC/DC | — | |

Cautions for Use

SAFETY WARNINGS

- Do not use the product under conditions that exceed the range of its specifications. It may cause overheating, smoke, or fire.
- Do not touch the recharging unit while the power is on. There is a danger of

electrical shock. Be sure to turn off the power when performing mounting, maintenance, or repair operations on the relay (including connecting parts such as the terminal board and socket).

- Check the connection diagrams in the catalog and be sure to connect the terminals correctly. Erroneous connections could lead to unexpected operating errors, overheating, or fire.

NOTES

1. Short across terminals

Do not short circuit between terminals when relay is energized. There is possibility of breaking the internal IC.

2. Surge voltages at the input

If reverse surge voltages are present at the input terminals, connect a diode in reverse parallel across the input terminals and keep the reverse voltages below the reverse breakdown voltage.

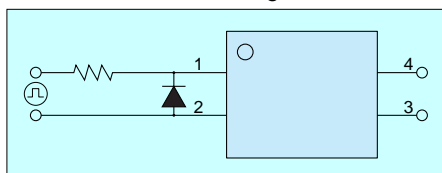

3. Recommended LED forward current (I_F)

It is recommended that the LED forward current (I_F) be kept at 5mA.

4. Ripple in the input power supply

If ripple is present in the input power supply, observe the following:

- 1) For LED operate current at E_{min}, maintain the value mentioned in the table of "Note 3. Recommended LED forward current (I_F)."

- 2) Keep the LED operate current at 50 mA or less at E_{max}.

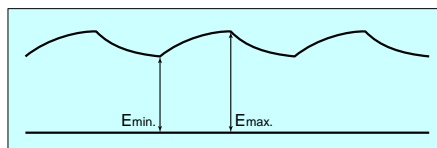

5. Output spike voltages

- 1) If an inductive load generates spike voltages which exceed the absolute maximum rating, the spike voltage must be limited.

Typical circuits are shown below.

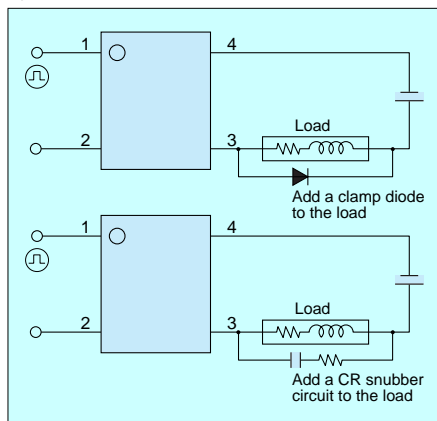

- 2) If spike voltages generated at the load are limited with a clamp diode and the circuit wires are long, spike voltages will occur by inductance. Keep wires as short as possible to minimize inductance.

6. Cleaning solvents compatibility

Dip cleaning with an organic solvent is recommended for removal of solder flux, dust, etc. Select a cleaning solvent from the following table. If ultrasonic cleaning is used, the severity of factors such as frequency, output power and cleaning solvent selected may cause loose wires and other defects. Make sure these conditions are correct before use. For details, please consult us.

| Cleaning solvent | | Compatibility (○: Yes X: No) |
|------------------|---------------------------------------|------------------------------|
| Chlorine-base | • Trichlene • Chloroethylene | ○ |
| Aqueous | • Indusco • Hollis • Lonco Terg | ○ |
| Alcohol-base | • IPA • Ethanol | ○ |
| Others | • Thinner • Gasoline | X |

7. Soldering

- 1) When soldering PC board terminals, keep soldering time to within 10 s at 260°C 500°F.

- (1) IR (Infrared reflow) soldering method

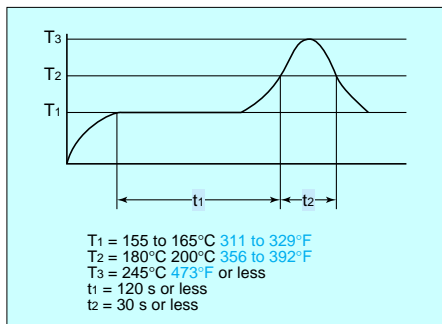

- (4) Soldering iron method

Tip temperature: 280 to 300°C 536 to 572°F

Wattage: 30 to 60 W

Soldering time: within 5 s

- 2) When soldering surface-mount terminals, the following conditions are recommended.

- (2) Vapor phase soldering method

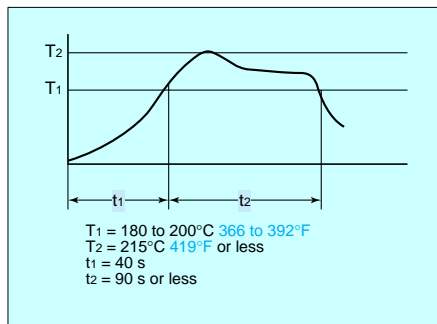

- (5) Others

Check mounting conditions before using other soldering methods (hot-air, hot plate, pulse heater, etc.)

- The temperature profile indicates the temperature of the soldered terminal on the surface of the PC board. The ambient

- (3) Double wave soldering method

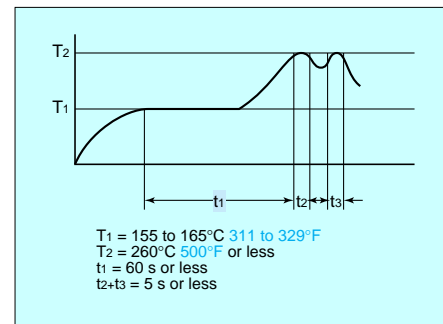

temperature may increase excessively. Check the temperature under mounting conditions.

- The conditions for the infrared reflow soldering apply when preheating using the VPS method.

AQY212GH

8. The following shows the packaging format

1) Tape and reel

mm inch

| Type | Tape dimensions | Dimensions of paper tape reel |
|----------------|---|-------------------------------|
| 4-pin SMD type | <p>(1) When picked from 1/2-pin side: Part No. AQY○○○GHAX (Shown above) (2) When picked from 3/4-pin side: Part No. AQY○○○GHAZ</p> | |

2) Tube

Devices are packaged in a tube so pin No. 1 is on the stopper B side. Observe correct orientation when mounting them on PC boards.

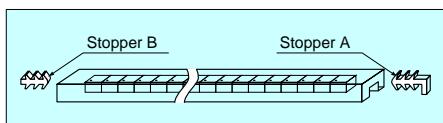

2) Storage under extreme conditions will cause soldering degradation, external appearance defects, and deterioration of the characteristics. The following storage conditions are recommended:

- Temperature: 0 to 45°C 32 to 113°F
- Humidity: Less than 70% R.H.
- Atmosphere: No harmful gasses such as sulfurous acid gas, minimal dust.

9. Transportation and storage

1) Extreme vibration during transport will warp the lead or damage the relay. Handle the outer and inner boxes with care.