

### PRODUCT SPECIFICATION

#### Product Description

The aSC7531 is a high-precision CMOS temperature sensor and voltage monitor with Simple Serial Transport (SST) compatible serial digital interface, intended for use in PC hardware monitor applications.

Communication of device capabilities, temperature and voltage readings take place over the high-speed bi-directional SST interface.

The SST temperature sensor provides a means for an analog signal to travel over a digital bus enabling remote temperature sensing in areas previously not monitored in the PC. The temperature sensor supports an internal and external thermal diode. aSC7531A is used with 2N3904 transistor connected as a remote diode, aSC7531B is used with CPU substrate diode.

The aSC7531 is available in MSOP-10 surface mount package.

#### Pin Configuration

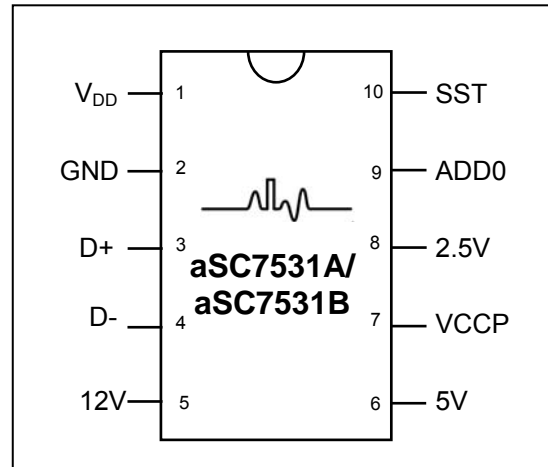

#### Features

- On-chip and remote temperature sensors
- Accuracy:
  - +/- 3°C over operational range
  - Internal +/- 2°C over 40°C to 70°C
  - Remote +/- 1°C over 50°C to 70°C
- Operational Range: -40°C to 125°C
- Temperature resolution: 0.125°C
- Voltage monitoring of 12V, 5V, 3.3V, 2.5V and V<sub>CCP</sub> to +/- 2% accuracy, 7.8mV resolution
- 1-wire SST serial interface
- Negotiable SST signaling rate up to 2-Mbps
- Internally corrected for diode non-ideality and series resistance
- 3-state address pin sets one of 3 SST bus address 0x48 through 0x4A
- 10-lead MSOP package
- MSL-1 per JEDEC J-STD-020C
- Pb-free Matte Sn lead finish & RoHS Compliant Packages

#### Applications

Desktop and Notebook Computers

#### Application Diagram

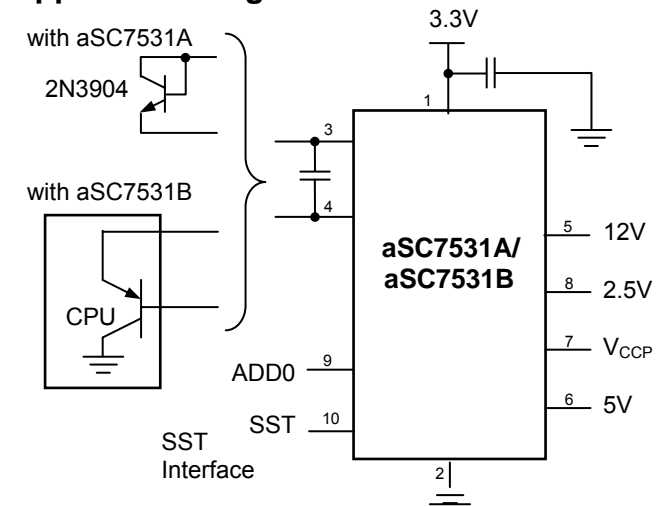

#### Ordering Information

Part Number	Package	Temp. Range and Operating Voltage	Marking	Supplied In
aSC7531AM10	10-Lead MSOP	-40°C to 125°C, 3.3V	531A Ayww	2500 units Tape & Reel
aSC7531BM10	10-Lead MSOP	-40°C to 125°C, 3.3V	531B Ayww	2500 units Tape & Reel

Ayww – Assembly site, year, workweek



# aSC7531A / aSC7531B

## Absolute Maximum Ratings<sup>1</sup>

Parameter	Rating	
Supply Voltage, $V_{DD}$	-0.3, +3.63V	
Voltage on any Digital Input or Output <sup>3</sup>	-0.3V to $V_{DD} + 0.3V$	
Voltage on 12V Analog Input <sup>3</sup>	16V	
Voltage on 5V Analog Input <sup>3</sup>	6.5V	
Voltage on Other Analog Inputs <sup>3</sup>	$V_{DD} + 0.3V$	
Input Current on any pin <sup>3</sup>	$\pm 5mA$	
Package Input Current <sup>3</sup>	$\pm 20mA$	
Relative Humidity (non-operating)	5% - 85% RH @ 25°C to 70°C	
Maximum Junction Temperature, $T_{Jmax}$	150°C	
Storage Temperature Range	-60°C to +150°C	
IR Reflow Peak Temperature	260°C	
Lead Soldering Temperature (10 sec.)	300°C	
ESD <sup>5</sup>	Human Body Model	2000 V
	Machine Model	250 V
	Charged-Device Model	>1000 V

## Notes:

1. Absolute maximum ratings are limits beyond which operation may cause permanent damage to the device. These are stress ratings only; functional operation at or above these limits is not implied. For guaranteed specifications and test conditions, see the Electrical Characteristics. The guaranteed specifications apply only for the test conditions listed. Some performance characteristics may degrade when the device is not operated under the listed test conditions.
2. All voltages are measured with respect to GND, unless otherwise specified.
3. When the input voltage ( $V_{IN}$ ) at any pin exceeds the power supplies ( $V_{IN} < (GND \text{ or } GND_A)$  or  $V_{IN} > V^+$ , except for SST and analog voltage inputs), the current at that pin should be limited to 5mA. The 20mA maximum package input current rating limits to number of pins that can safely exceed the power supplies with an input current of 5mA to four.
4. The maximum power dissipation must be de-rated at elevated temperatures and is dictated by  $T_{Jmax}$ ,  $\theta_{JA}$  and the ambient temperature,  $T_A$ . The maximum allowable power dissipation at any temperature is  $PD = (T_{Jmax} - T_A) / \theta_{JA}$ . It must also take into account self-heating that can adversely affect the accuracy of internal sensors.
5. Human Body Model: 100pF capacitor discharged through a 1.5k $\Omega$  resistor into each pin. Machine Model: 200pF capacitor discharged directly into each pin. Charged-Device Model is per JESD22-C101C.

## Electrical Characteristics<sup>6</sup>

(-40°C  $\leq T_A \leq$  +125°C,  $V_{DD} = 3.3V$  unless otherwise noted. Specifications subject to change without notice)

Parameter	Conditions	Min	Typ	Max	Units
Supply Voltage	$V_{DD}$	3.0	3.3	3.6	V
SST Signal		Meets SST Specification Version 1.0 for 1.5V interface			
Local Sensor Accuracy <sup>7,8</sup>	-40°C $\leq T_A \leq$ +125°C			$\pm 3$	°C
	40°C $\leq T_A \leq$ 70°C			$\pm 2$	°C
Local Sensor Resolution			0.125		°C
Remote Diode Sensor Accuracy <sup>7,8,9</sup>	0°C $\leq T_A \leq$ 70°C, -40°C $\leq T_D \leq$ +125°C			$\pm 3$	°C
	0°C $\leq T_A \leq$ 70°C, 50°C $\leq T_D \leq$ 70°C			$\pm 1$	°C
Remote Diode Sensor Resolution			0.125		°C
Temperature Monitor Cycle Time <sup>10</sup>	$t_c$			0.2	Sec
ADC Total Unadjusted Error <sup>11</sup>	TUE			2	% FS
ADC Differential Nonlinearity	DNL		$\pm 1$		LSB
ADC Power Supply Sensitivity	PSS		$\pm 1$		% / V
ADC Resolution			7.8		mV
ADC Total Monitoring Cycle Time <sup>10</sup>	$t_c$			0.2	Sec
ADC Input Resistance			140	$\geq 100$	k $\Omega$

## Notes:

6. These specifications are guaranteed only for the test conditions listed.
7. Accuracy (expressed in °C) = Difference between the aSC7531 reported temperature and the device temperature.
8. The aSC7531 can be read at any time without interrupting the temperature conversion process.
9. For the aSC7531A, calibration of the remote diode sensor input is set to meet the accuracy limits with a diode-connected 2N3904 that has a non-ideality factor of 1.0046 with a series resistance of 0.6 $\Omega$ . For the aSC7531B, calibration of the remote diode sensor input is set to meet the accuracy limits with a CPU substrate diode that has a non-ideality factor of 1.009 with a series resistance of 4.52 $\Omega$ .
10. Total monitoring cycle time for all temperature and analog input voltage measurements is 0.2 second.
11. TUE includes Offset, Gain and Linearity errors of the ADC.

## Pin Descriptions

Pin #	Name	Direction	Description
1	V <sub>DD</sub> (3.3V)	Supply	Supply Voltage, 3.3V +/- 10% (measured 3.3V input)
2	GND	Supply	Ground
3	D+	Current Source	Remote Diode Anode or Positive Lead
4	D-	Current Sink	Remote Diode Cathode or Negative Lead
5	12V	Input	12V PC System Supply Voltage
6	5V	Input	5V PC System Supply Voltage
7	V <sub>CCP</sub>	Input	CPU Core Voltage (1.2V to 1.5V)
8	2.5V	Input	2.5 V PC System Supply Voltage
9	ADD0	Input	Device Address Tri-State selector: Ground, Float or V <sub>DD</sub>
10	SST	Input	Digital Input / Output. SST Bi-directional Data Line.

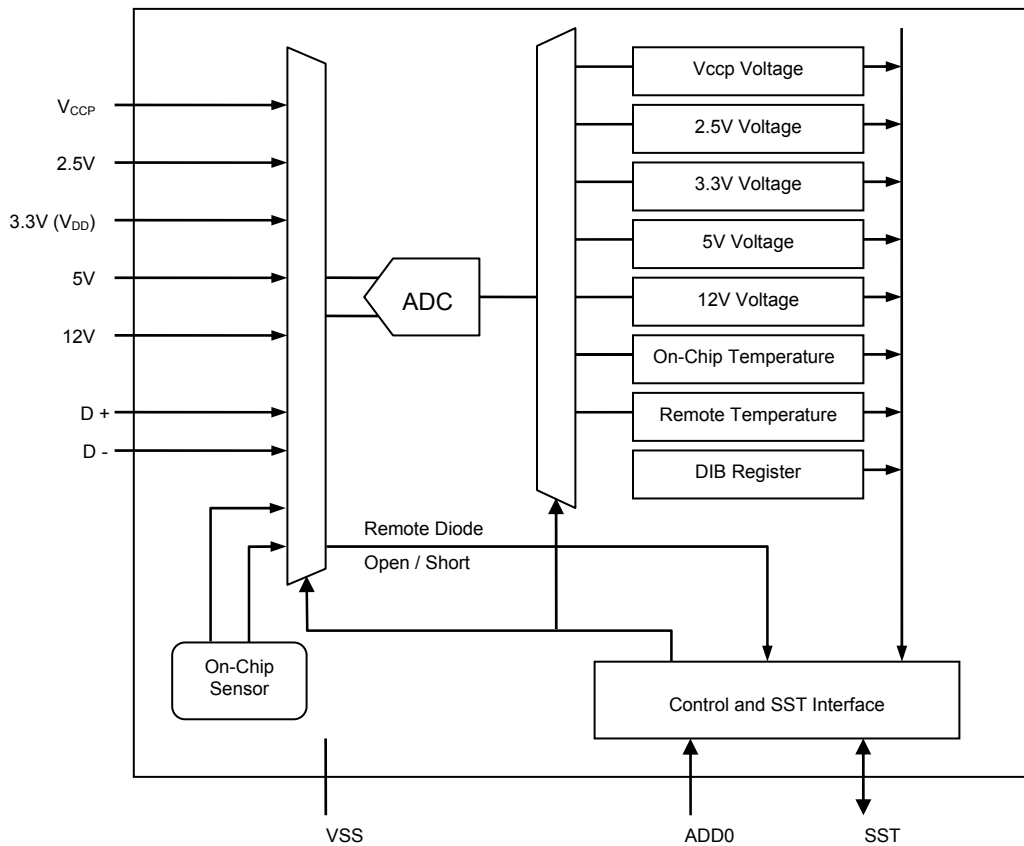

**Figure 1. Block Diagram**



## SST Sensors

The SST voltage and temperature sensor provides a means for an analog signal to travel over a single-wire digital bus enabling remote voltage and temperature sensing in areas previously not monitored in the PC. The temperature sensor supports an internal temperature sensor and external thermal diodes.

This section outlines general requirements for Simple Serial Transport (SST) sensors intended for use in PC desktop applications that conform to SST Version 1.0 specification.

The aSC7531 is a Combination Voltage and Temperature Sensor. It reports external temperature sensed by a remote diode-connected transistor and an internal temperature measurement. It also has five voltage measurements: 2.5V, 3.3V, 5V, 12V, and  $V_{CCP}$ .

## Addressing

The aSC7531 complies with the address range set aside for fixed-address, discoverable devices as defined in the SST Specification Version 1.0. Combination voltage and temperature sensors use fixed addresses in the range of 0x48 to 0x4A. The aSC7531 may be programmed to any of these addresses via the address select pin AD0.

## Frame Check Sequence (FCS)

Each message requires a frame check sequence byte to ensure reliable data exchange between host and client. The message originator and client both make an FCS calculation.

One FCS byte must be returned from the message target to the originator after all bytes including the header and the data block are written. If data is read from the target, a second FCS byte must follow the data block read.

The FCS byte is the result of an 8-bit cyclic redundancy check (CRC) of the each data block preceding the FCS up to the most recent, earlier FCS byte. The first FCS in the message does not include the two address timing negotiation '0' bits that precede the address byte or the message timing negotiation bit after the address byte. The first FCS does include the address byte in its computation. The FCS is initialized at 0x00 and is calculated in a way that conforms to a CRC-8 represented by the CRC polynomial,  $C(x) = x^8 + x^2 + x + 1$ .

## Bus Voltage

All SST sensor devices used for PC applications must be capable of operating the SST interface portion of the sensor device at 1.5 volts as defined in 1.5 Volt Static (DC) Characteristics section of the SST Version 1.0 specification.

## Bus Timing

All SST sensor devices must be able to negotiate timing and operate at a maximum bus transfer rate of 2-Mbps. If the bus address timing is negotiated at a lower rate due to the performance limitations of other devices on the bus, the sensor device will operate at that lower rate.

## Device Power-on Timing

Following a power-on reset, such as a system transitioning from S3-S5 to S0, the aSC7531 will be able to participate in the address and message timing negotiation and respond to required SST bus commands such as respond to a GetDIB() command within 10ms of the device's  $V_{DD}$  rail reaching 90%. The aSC7531 has an internal power on reset and will be fully functional within 50ms of power on.

The aSC7531 does not employ any device power management.

## Voltage and Temperature Sensor Data

### Little Endian Format

The bit level transfer is defined in the SST specification. The 2-byte data values are returned in little Endian format, in other words, the LSB is sent first followed by MSB.

For multi-function devices that allow access to multiple sensors, the data is returned LSB followed by the MSB for the first sensor, LSB followed by the MSB for the second sensor, and so on. The specific order is explicitly specified in the command description.

### Atomic Readings

The aSC7531 ensures that every value returned is derived from a single analog to digital conversion and is not skewed (e.g. the MSB and the LSB come from two different conversions).

### Conversion Time

The maximum refresh time for all voltage and temperature values is 200ms. The aSC7531 provides the logic to ensure all readings meet the conversion time requirements.

There are 7 channels (5 voltage and 2 temperature) channels which must be measured every 250ms.

## Temperature Data

### Data Precision, Accuracy and Resolution

The temperature data meets the following minimum requirements:

- Operational Range: -40°C to +125°C
- Internal Sensor Accuracy:
  - +/- 3°C over operational range
  - +/- 2°C over 40°C to 70°C
- Remote Sensor Accuracy (when TA is from 0°C to 70°C):
  - +/- 3°C over operational range
  - +/- 1°C over 50°C to 70°C
- Resolution: 0.125°C

### Temperature Data Format

The data format is capable of reporting temperature values in the range of +/-512°C. The temperature sensor data is returned as a 2's complement 16-bit binary value. It represents the number of 1/64°C increments in the actual reading. This allows temperatures to be represented with approximately a 0.016°C resolution.



Values that would represent temperatures below -273.15°C (0 K or absolute zero) are reserved and are not be returned except as specifically noted.

For the aSC7531 the required resolution is 0.125°C. Bits [2:0] will be defined but they are beyond the required resolution. The sign bit will indicate a negative temperature except when reporting an error condition (see [Sensor Error Condition](#)).

Temperature	2's complement representation
80°C	0001 0100 0000 0000
79.875°C	0001 0011 1111 1000
1°C	0000 0000 0100 0000
0°C	0000 0000 0000 0000
-1°C	1111 1111 1100 0000
-5°C	1111 1110 1100 0000

**Table 1. Temperature Representation**

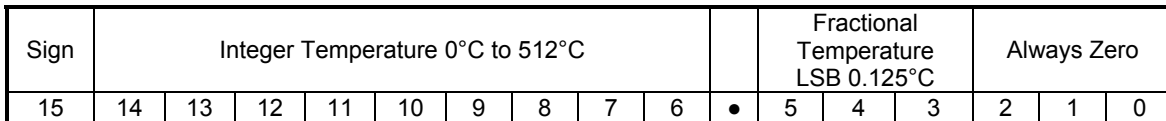

**Figure 2. Temperature Reading**

### A to D Converter Resolution and Mapping

The mapping of the A-D converter bit values is a two's complement representation with the binary point between bits 5 and 6 of the 16-bit data word. Bit 15 is the sign, bits 14 through 6 are integer temperature in degrees, bits 5 down to 3 are the fractional part with 0.125°C as the LSB. The lowest 3 bits are set to zero.

### Temperature Inputs

The aSC7531A has an internal thermal sensor plus an external sensor using a remote diode. The remote sensor is calibrated for a 2N3904 NPN transistor that has a non-ideality ( $\eta$ ) factor of approximately 1.0046. Use of the remote diode is discussed in the Applications Information section.

The aSC7531B also has an internal thermal sensor plus an external sensor using a remote diode however the remote sensor is calibrated for an Intel CPU (Pentium 4, 65nm) that has a non-ideality ( $\eta$ ) factor of approximately 1.009. Use of the remote diode is discussed in the Applications Information section.

It is recommended that the actual transistor type and manufacturers chosen for the remote sensor be characterized for non-ideality as part of system qualification.

### Sensor Error Condition

The aSC7531 has the capability to detect and report open or shorted external diode inputs per Sensor Error Condition.

When an error or failure condition is detected, the sensor device must return a large negative value in response to either the GetIntTemp() or GetExtTemp() command. In this manner software is provided with a means to determine whether or not the sensor is working normally and that the data returned is good.

The aSC7531 will write one of the values from the table below to appropriate memory locations for GetIntTemp() and/or GetExtTemp().

The aSC7531 uses the OEM defined values of 0x8102 (open) and 0x8103 (short) rather than the generic errors defined for codes 0x8000 to 0x8003.

Error Code	Description
0x8000 to 0x80FF	Reserved
0x8102	Remote Diode Open
0x8103	Remote Diode Short
0x8100-0x81FF	Reserved

**Table 2. Error Codes**

## Voltage Data

### Accuracy and Resolution

The aSC7531 measures the following voltages:

- Measured voltages:
  - 12V
  - 5V
  - 3.3V
  - 2.5V
  - $V_{CCP}$
- Measurement Error: +/- 2% of full scale
- Resolution: 7.8 mV

### Voltage Data Format

The data format used to report voltage allows values in the range of +/-32V. The voltage sensor data is returned as a 16-bit 2's complement binary value. It represents the number of 1/1024 volts in the reading if extended the full 16-bits. This allows voltages to be represented with approximately a 1mV resolution.



Voltage	2's complement representation
5.0 V	0001 0100 0000 0000
4.992 V	0001 0011 1111 1000
1 V	0000 0100 0000 0000
0.0 V	0000 0000 0000 0000
-1 V	1111 1100 0000 0000
-4.992 V	1110 1100 0000 1001
-5.0 V	1110 1100 0000 0000

**Table 3. Voltage Representation**

Actual aSC7531 reports are only positive in sign and 13-bits or 7.8mV in resolution. The sign bit will always be 0 since the measured voltages are only positive values. Below the integer bits, the fractional voltage reported by the aSC7531 are bits 9 through 3, with LSB = 7.8mV. Bits 2 through 0 are always zero. The aSC7531 cannot measure voltages greater than 16V.

Sign	Integer Voltage 0 to 31V							Fractional Voltage LSB = 1/128V						Always Zero		
15	14	13	12	11	10	●	9	8	7	6	5	4	3	2	1	0

**Figure 3. Voltage Reading**

## SST Interface

### Multi Client Mode

Sensors operate in multi-client mode for read bit timing. Reference the SST Specification Version 1.0 for details.

### SST Device Commands

#### GetDIB() Command (0xF7)

Read the Device Identifier Block (DIB). The read length of the command is either 8 or 16 bytes. 8 bytes is the minimum number of bytes populated by a fixed address discoverable client.

Write Data Length: 0x01  
 Read Data Length: 0x08/0x10  
 Command Code: 0xF7

Note: Un-shaded table entries are created by the host. Shaded entries are the response bytes from the aSC7531 to the host.

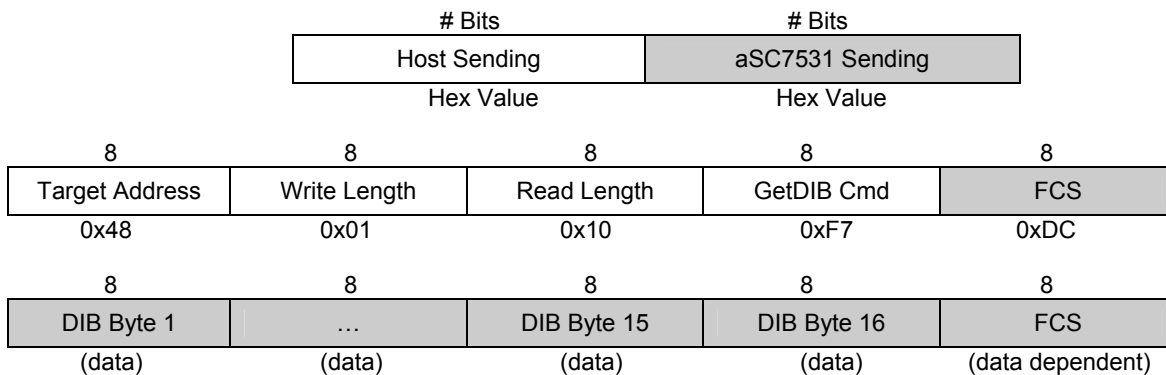

**Figure 4. GetDIB() Command (16-byte read length)**

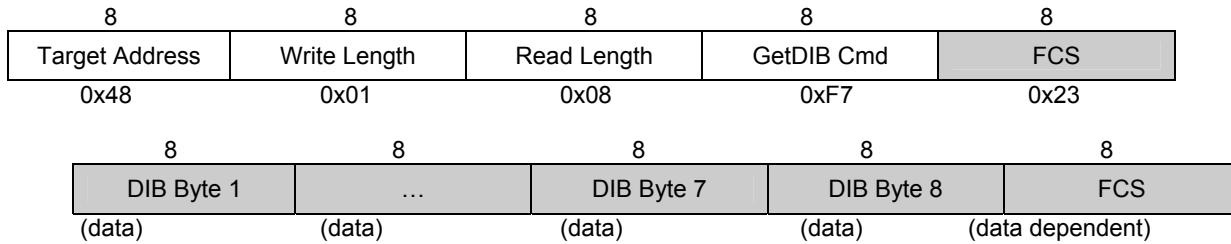
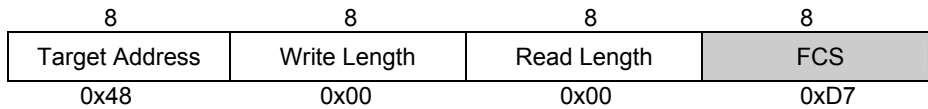

**Figure 5. GetDIB() Command (8-byte read length)**

***Ping() Command***

The Ping() command provides a safe means for software to verify that a device is responding at a particular address.

Write Data Length: 0x00  
 Read Data Length: 0x00  
 Command Code: none

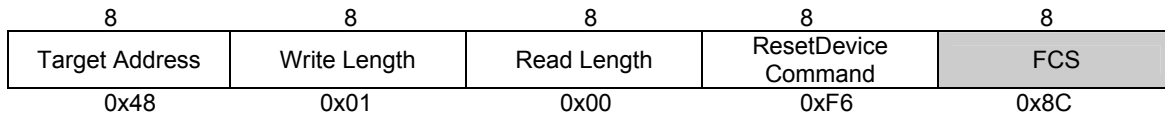

**Figure 6. Example of Ping()**

***ResetDevice() Command***

The ResetDevice() command is used to reset all device functions to their power-on reset values. It is used by the system to recover from serious hardware or bus errors.

Write Data Length: 0x01  
 Read Data Length: 0x00  
 Command Code: 0xF6



**Figure 7. ResetDevice() format targeting a non-default address**

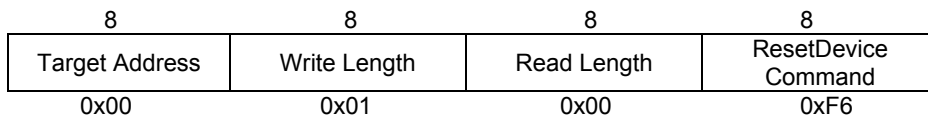

**Figure 8. ResetDevice() format targeting the default address**

### Sensor Command Summary

#### **GetIntTemp()**

Returns the temperature of the device's internal thermal sensor.

Write Data Length: 0x01  
 Read Data Length: 0x02  
 Command Code: 0x00

Example bus transaction for a thermal sensor device located at address 0x48 returning a value of 60°C:



**Figure 9. Get Internal Temperature Command Example**

#### **GetExtTemp()**

Returns the temperature of the external thermal diode.

Write Data Length: 0x01  
 Read Data Length: 0x02  
 Command Code: 0x01

#### **GetAllTemps()**

Returns a 4-byte block of data containing both the Internal and External temperatures in the following order Internal then External temperatures.

Write Data Length: 0x01  
 Read Data Length: 0x04  
 Command Code: 0x00

#### **GetVolt12V()**

Returns the voltage attached to the 12 volt pin.

Write Data Length: 0x01  
 Read Data Length: 0x02  
 Command Code: 0x10

Example bus transaction for a multifunction device located at address 0x48 returning a value of 12 volts:

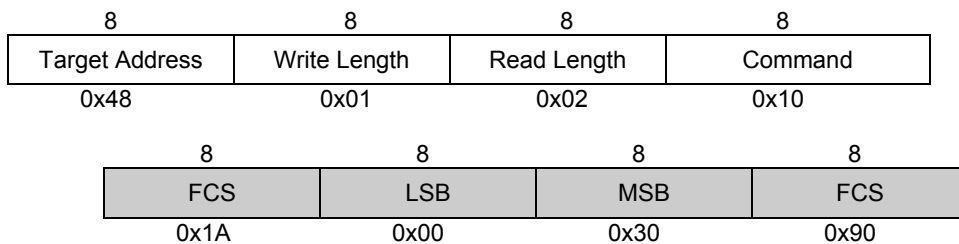

**Figure 10. Example Read of 12-Volt Value**





**GetVolt5V()**

Returns the voltage attached to the 5 volt pin.

Write Data Length: 0x01  
Read Data Length: 0x02  
Command Code: 0x11

**GetVolt3p3V()**

Returns the voltage attached to the 3.3 volt pin.

Write Data Length: 0x01  
Read Data Length: 0x02  
Command Code: 0x12

**GetVolt2p5V()**

Returns the voltage attached to the 2.5 volt pin.

Write Data Length: 0x01  
Read Data Length: 0x02  
Command Code: 0x13

**GetVoltVccp()**

Returns the voltage attached to the V<sub>CCP</sub> pin.

Write Data Length: 0x01  
Read Data Length: 0x02  
Command Code: 0x14

**GetAllVoltages()**

Returns a block of 10-bytes of data containing all 5 voltages in the following order 12V, 5V, 3.3V, 2.5V, and V<sub>CCP</sub>

Write Data Length: 0x01  
Read Data Length: 0x0A  
Command Code: 0x10

**Optional SST Device Commands**

The optional SST commands *Alert()*, *Suspend()* are not supported in the aSC7531.

**Vendor Specific Extensions**

The vendor specific command codes are in the range from 0xE0 and 0xE7. Reading and writing to specific internal registers is provided for custom tuning of sensor response characteristics.

**WriteReg()**

Writes to the sensor's internal registers.

Write Data Length: 2+N (command + address + Number of bytes to write)  
Read Data Length: 0x00  
Command Code: 0xE0

Example bus transaction to write to a sensor located at address 0x48. This example writes 2 consecutive locations (0x20 and 0x21) to values 0x25 and 0x28.

8	8	8	8
Target Address	Write Length	Read Length	Command
0x48	0x04	0x00	0xE0

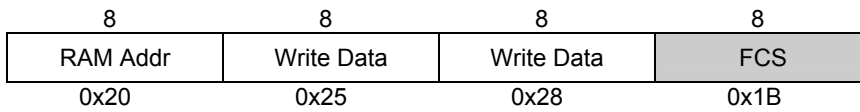

**Figure 11. Example Register Write**

**ReadReg()**

Reads from the sensor's internal registers.

Write Data Length: 0x02 (command + address)  
 Read Data Length: N (Number of bytes to read)  
 Command Code: 0xE1

Example bus transaction to read a sensor located at address 0x48. This example reads 2 consecutive locations (0x20 and 0x21).

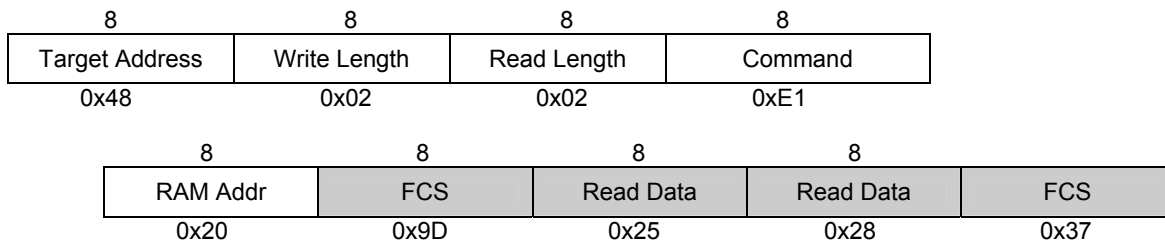
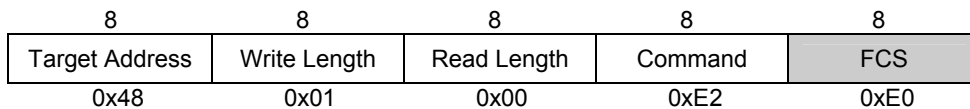

**Figure 12. Example Register Read**

**VenCmdEnable()**

Vendor Command Enable enables the Vendor Specified Extensions.

Write Data Length: 0x01  
 Read Data Length: 0x00  
 Command Code: 0xE2

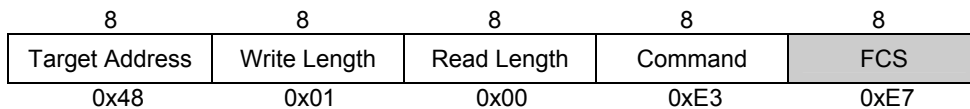

**Figure 13. Vendor Command Enable**

**VenCmdDisable()**

Vendor Command Disable disables the Vendor Specified Extensions.

Write Data Length: 0x01  
 Read Data Length: 0x00  
 Command Code: 0xE3



**Figure 14. Vendor Command Disable**

## Reserved or Unsupported Commands

Attempts to access the sensor using a reserved or unsupported command will not result in the device or bus failure. The sensor will return a modified FCS when any of the following commands are received. To modify the FCS the sensor will invert all of the bits in the correct FCS (1's complement). A modified FCS is also called an Abort FCS.

The sensor will return an Abort FCS (modified FCS) for a reserved and unsupported command code (commands codes between 0xE4 to 0xF5 and 0xF8 to 0xFF).

The sensor will return an Abort FCS (modified FCS) for reserved commands (command codes 0x02 to 0x0F and 0x15 to 0xDF).

The sensor will return an Abort FCS (modified FCS) for unused vendor specific test and manufacturing command codes (command codes 0xE8 to 0xEF). If any of these types of commands exist, they will be disabled during normal operation.

## Malformed Commands

A malformed command is one which is valid but has an incorrect write or read length for the given command.

If a get temperature or get voltage command with a write length not equal to 1 is sent, then the aSC7531 will send an Abort FCS and wait for a new command. An Abort FCS will be formed by creating a 1's complement of the good FCS.

If a get temperature or get voltage command and the read length is not equal to 2, 4, or 10 then the aSC7531 will send an Abort FCS and wait for a stop on the SST bus. See the Command Summary section for the expected Write and Read lengths of the legal commands.

There will be no checking for malformed WriteReg() and ReadReg() commands (Vendor Specific Extensions).

## Command Summary

Hex Cmd	Command Name	Received Bytes	Wr Len	Rd Len	Bytes Sent by Client
-	<a href="#">Ping()</a>	3(target,wr,rd)	0	0	FCS
0x00	<a href="#">GetIntTemp()</a>	4(target,wr,rd,cmd)	1	2	FCS/2/FCS
0x01	<a href="#">GetExtTemp()</a>	4(target,wr,rd,cmd)	1	2	FCS/2/FCS
0x00	<a href="#">GetAllTemps()</a>	4(target,wr,rd,cmd)	1	4	FCS/4/FCS
0x02-0x0F	Unsupported				Abort FCS
0x10	<a href="#">GetVolt12V()</a>	4(target,wr,rd,cmd)	1	2	FCS/2/FCS
0x11	<a href="#">GetVolt5V()</a>	4(target,wr,rd,cmd)	1	2	FCS/2/FCS
0x12	<a href="#">GetVolt3p3V()</a>	4(target,wr,rd,cmd)	1	2	FCS/2/FCS
0x13	<a href="#">GetVolt2p5V()</a>	4(target,wr,rd,cmd)	1	2	FCS/2/FCS
0x14	<a href="#">GetVoltVccp()</a>	4(target,wr,rd,cmd)	1	2	FCS/2/FCS
0x10	<a href="#">GetAllVoltages()</a>	4(target,wr,rd,cmd)	1	10	FCS/10/FCS
0x15-0xDF	Unsupported				Abort FCS
0xE0	<a href="#">WriteReg()</a>	4(target,wr,rd,cmd)	3+	0	FCS
0xE1	<a href="#">ReadReg()</a>	4(target,wr,rd,cmd)	2	1+	FCS/1+/FCS
0xE2	<a href="#">VenCmdEnable()</a>	4(target,wr,rd,cmd)	1	0	FCS
0xE3	<a href="#">VenCmdDisable()</a>	4(target,wr,rd,cmd)	1	0	FCS
0xE4-0xF5	Unsupported				Abort FCS
0xF6	<a href="#">ResetDevice()</a>	4(target,wr,rd,cmd)	1	0	FCS
0xF6	<a href="#">ResetDevice()</a>	4(target,wr,rd,cmd)	1	0	None if default address (0x00)
0xF7	<a href="#">GetDIB()</a>	4(target,wr,rd,cmd)	1	8	FCS/8/FCS
0xF7	<a href="#">GetDIB()</a>	4(target,wr,rd,cmd)	1	16	FCS/16/FCS
0xF8-0xFF	Unsupported				Abort FCS

**Table 4. Command Summary**

## Device Identifier Block (DIB)

The Device Identifier Block describes the identity and functions of a client device on the SST bus. Sixteen bytes are allocated for this function as shown in Figure 15. Device Identifier Block is returned by the aSC7531 with a GetDIB() command. The aSC7531 returned values are shown with the description of each field below.

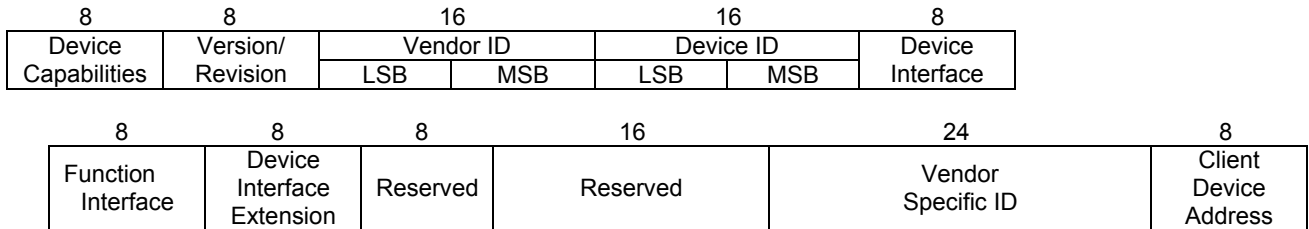

**Figure 15. Device Identifier Block**

## Device Capabilities Field (1-byte)

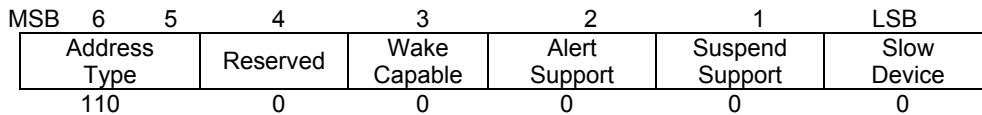

**Figure 16. Device Capabilities Field**

## Version / Revision Field (1-byte)

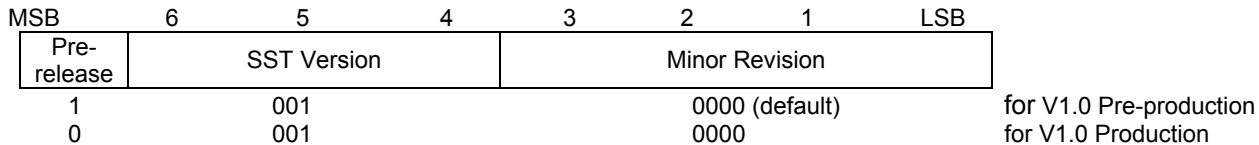

**Figure 17. Version / Revision Field**

## Vendor ID Field (2-bytes)

Andigilog Vendor ID is 16 bits = 0x19C9 (This field is stored in the format LS Byte, MS Byte = 0xC919). Vendor IDs can be found at: [http://www.pcisig.com/membership/vid\\_search](http://www.pcisig.com/membership/vid_search)

## Device ID Field (2-bytes)

This field uniquely identifies the device from a specific vendor. Place the least significant byte as the first byte and the most significant byte as the second byte.

Part Number	Value (MS,LS)	Stored Value (LS,MS)
aSC7531A or aSC7531B	0x7531	0x3175

**Device Interface Field (1-byte)**

The vendor sets to '1', bit positions in this field in the event the device supports higher layer protocols that are industry specific using Table 5.

Value = 0x02

Bit	Protocol	Meaning
7	-	Reserved for future use , must be set = '0'
6	-	Reserved for future use , must be set = '0'
5	IPMI	Device supports additional access and capabilities per the IPMI specification.
4	ASF	Device supports additional access and capabilities per the ASF specification.
3	Serial-ATA	Device supports additional access and capabilities per the serial-ATA specification.
2	PCI-Express	Device supports additional access and capabilities per the PCI Express specification.
1	SST	Device supports additional access and capabilities per the SST Functional Descriptor Specification (to be published at a future date).
0	OEM	Device supports vendor-specific additional access and capabilities per the Vendor ID and Device ID.

**Table 5. Device Interface Field**

**Function Interface Field (1-byte)**

This field provides a mechanism for a device to pass higher-layer SST device-specific information.

Value = 0x00

**Device Interface Extension Field (1-byte)**

This field is used to provide additional information about the device to the upper layers of software.

Value = 0x00

**Reserved Field (3-bytes)**

Value = 0x00 0x00 0x00

**Vendor Specific ID Field (1-byte)**

This field is set by the vendor in a way that uniquely identifies this device apart from all others with an otherwise common DIB content.

Value = 0x00 – For Fixed address devices this field may be set to zero.

**Client Device Address (1-byte)**

SST Client Device Address is set according to the connection of the ADD0 pin. The combination part appears to software as two sensors, a simple temperature and a simple voltage sensor residing at the same address. Float is defined as an unconnected pin.

ADD0	Address
Ground	0x48
Float	0x49
V <sub>DD</sub>	0x4A

## Applications Information

### Remote Diodes

The aSC7531 is designed to work with a variety of remote sensors in the form of a diode-connected transistor or the substrate thermal diode of a CPU or graphics controller. Actual diodes are not suited for these measurements.

There is some variation in the performance of these diodes, described in terms of its departure from the ideal diode equation. This factor is called diode non-ideality,  $nf$ .

The equation relating diode temperature to a change in thermal diode voltage with two driving currents is:

$$\Delta V_{BE} = (nf) \frac{KT}{q} \ln(N)$$

where:

$nf$  = diode-connected 2N3904 or CPU substrate non-ideality factor.

$K$  = Boltzman's constant, ( $1.38 \times 10^{-23}$ ).

$T$  = diode junction temperature in Kelvins.

$q$  = electron charge ( $1.6 \times 10^{-19}$  Coulombs).

$N$  = ratio of the two driving currents (10).

The aSC7531A is designed and trimmed for an expected  $nf$  value of 1.0046, based on the typical value for the 2N3904. There is also a tolerance on the value provided. Table 6 gives a representative sample of what one may expect in the range of non-ideality.

For the aSC7531A, when thermal diode has a non-ideality factor other than 1.0046 the difference in temperature reading at a particular temperature may be interpreted with the following equation:

$$T_{actual} = T_{reported} \left( \frac{1.0046}{n_{actual}} \right)$$

where:

$T_{reported}$  = reported temperature in temperature register.

$T_{actual}$  = actual remote diode temperature.

$n_{actual}$  = selected diode's non-ideality factor,  $nf$ .

Temperatures are in Kelvins or °C + 273.15.

This equation assumes that the series resistance of the remote diode 0.6Ω.

Although the temperature error caused by non-ideality difference is directly proportional to the difference from 1.0046, a small difference in non-ideality results in a relatively large difference in temperature reading. For example, if there were a ±1% tolerance in the non-Ideality of a diode it would result in a ±2.7 degree difference (at 0°C) in the result ( $0.01 \times 273.15$ ).

The aSC7531B is designed and trimmed for an expected  $nf$  value of 1.009, based on the typical value for the 65nm Pentium CPU. There is also a tolerance on the value provided. The values for CPUs may have different nominal values and tolerances. Consult the CPU or GPU manufacturer's data sheet for the  $nf$  factor. Table 6 gives a representative sample of what one may expect in the range of non-ideality. The trend with CPUs is for a lower value with a larger spread.

When thermal diode has a non-ideality factor other than 1.009 the difference in temperature reading at a particular temperature may be interpreted with the following equation:

$$T_{actual} = T_{reported} \left( \frac{1.009}{n_{actual}} \right)$$

where:

$T_{reported}$  = reported temperature in temperature register.

$T_{actual}$  = actual remote diode temperature.

$n_{actual}$  = selected diode's non-ideality factor,  $nf$ .

Temperatures are in Kelvins or °C + 273.15.

This equation assumes that the series resistance of the remote diode 4.52Ω.

Although the temperature error caused by non-ideality difference is directly proportional to the difference from 1.009, but a small difference in non-ideality results in a relatively large difference in temperature reading. For example, if there were a ±1% tolerance in the non-Ideality of a diode it would result in a ±2.7 degree difference (at 0°C) in the result ( $0.01 \times 273.15$ ).

This difference varies with temperature such that a fixed offset value may only be used over a very narrow range. Typical correction method required when measuring a wide range of temperature values is to scale the temperature reading in the host firmware.

Part	$nf$ Min	$nf$ Nom	$nf$ Max	Series Res
Pentium™ III (CPUID 68h)	1.0057	1.008	1.0125	
Pentium 4, 130nM	1.001	1.002	1.003	3.64
Pentium 4, 90nM		1.011		3.33
Pentium 4, 65nM	1.000	1.009	1.050	4.52
Intel Pentium M	1.0015	1.0022	1.0029	3.06
2N3904	1.003	1.0046	1.005	0.6

**Table 6 Representative CPU Thermal Diode and Transistor Non-Ideality Factors**

## Discrete Remote Diodes

When sensing temperatures other than the CPU or GPU substrate, an NPN or PNP transistor may be used. Most commonly used are the 2N3904 and 2N3906. These have characteristics similar to the CPU substrate diode with non-ideality around 1.0046. They are connected with base to collector shorted as shown in Figure 18.

While it is important to minimize the distance to the remote diode to reduce high-frequency noise pickup, they may be located many feet away with proper shielding. Shielded, twisted-pair cable is recommended, with the shield connected only at the aSC7531A end as close as possible to the ground pin of the device.

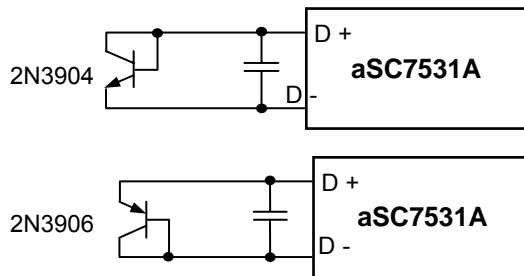
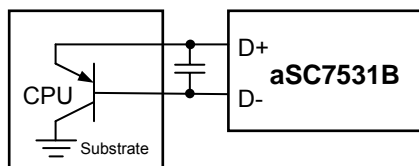

**Figure 18 Discrete Remote Diode Connection**

As with the CPU substrate diode, the temperature reported will be subject to the same errors due to non-ideality variation and series resistance. However, the transistor's die temperature is usually not the temperature of interest and care must be taken to minimize the thermal resistance and physical distance between that temperature and the remote diode. The offset and response time will need to be characterized by the user.

## CPU or ASIC Substrate Remote Diodes

A substrate diode is a parasitic PNP transistor that has its collector tied to ground through the substrate and the base (D-) and emitter (D+) brought out to pins. Connection to these pins is shown in Figure 19. The non-ideality figures in Table 6 include the effects of any package resistance and represent the value seen from the CPU socket. The temperature indicated will need to be compensated for the departure from a non-ideality of 1.0046 and series resistance of 0.6Ω.



**Figure 19 CPU Remote Diode Connection**

## Series Resistance

Any external series resistance in the connections from the aSC7531 to the CPU pins should be accounted for in interpreting the results of a measurement.

The impact of series resistance on the measured temperature is a result of measurement currents developing offset voltages that add to the diode voltage. This is relatively constant with temperature and may be corrected with a fixed value in the offset register. To determine the temperature impact of resistance is as follows:

$$\Delta T_R = R_S \times T_V \times \Delta I_D$$

or,

$$\Delta T_R = R_S \times \left( \frac{135 \mu A}{200 \mu V / ^\circ C} \right) = R_S \times 0.675^\circ C / \Omega$$

where:

$\Delta T_R$  = difference in the temperature reading from actual.

$R_S$  = total series resistance of interconnect (both leads).

$\Delta I_D$  = difference in the two diode current levels (135μA).

$T_V$  = scale of temperature vs.  $V_{BE}$  (200μV/°C).

For example, a total series resistance of 10Ω would give an offset of +6.75°C.

## Board Layout Considerations

The distance between the remote sensor and the aSC7531 should be minimized. All wiring should be defended from high frequency noise sources and a balanced differential layout maintained on D+ and D-.

Any noise, both common-mode and differential, induced in the remote diode interconnect may result in an offset in the temperature reported. Circuit board layout should follow the recommendation of Figure 20. Basically, use 10-mil lines and spaces with grounds on each side of the differential pair. Choose the ground plane closest to the CPU when using the CPU's remote diode.

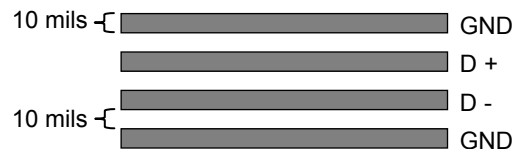

**Figure 20 Recommended Remote Diode Circuit Board Interconnect**

Noise filtering is accomplished by using a bypass capacitor placed as close as possible to the aSC7531 D+ and D- pins. A 1.0nF ceramic capacitor is recommended, but up to 3.3nF may be used. Additional filtering takes place within the aSC7531.



It is recommended that the following guidelines be used to minimize noise and achieve highest accuracy:

1. Place a 0.1 $\mu$ F bypass capacitor to digital ground as close as possible to the power pin of the aSC7531.
2. Match the trace routing of the D+ and D- leads and use a 1.0nF filter capacitor close to the aSC7531. Use ground runs along side the pair to minimize differential coupling as in Figure 20.
3. Place the aSC7531B as close to the CPU or GPU remote diode leads as possible to minimize noise and series resistance.
4. Avoid running diode connections close to or in parallel with high-speed busses, staying at least 2cm away.
5. Avoid running diode connections close to on-board switching power supply inductors.
6. PC board leakage should be minimized by maintaining minimum trace spacing and covering traces over their full length with solder mask.

## Thermal Considerations

The temperature of the aSC7531 will be close to that of the PC board on which it is mounted. Conduction through the leads is the primary path for heat flow. The reported local sensor is very close to the circuit board temperature and typically between the board and ambient.

In order to measure PC board temperature in an area of interest, such as the area around the CPU where voltage regulator components generate significant heat, a remote diode-connected transistor should be used. A surface-mount SOT-23 or SOT-223 is recommended. The small size is advantageous in minimizing response time because of its low thermal mass, but at the same time it has low surface area and a high thermal resistance to ambient air. A compromise must be achieved between minimizing thermal mass and increasing the surface area to lower the junction-to-ambient thermal resistance.

In order to sense temperature of air-flows near board-mounted heat sources, such as memory modules, the sensor should be mounted above the PC board. A TO-92 packaged transistor is recommended.

The power consumption of the aSC7531 is relatively low and should have little self-heating effect on the local sensor reading. At the highest measurement rate the dissipation is less than 2mW, resulting in only a few tenths of a degree rise.



## M10 Package – 10-Lead MSOP Package Dimensions

Pb-Free Package

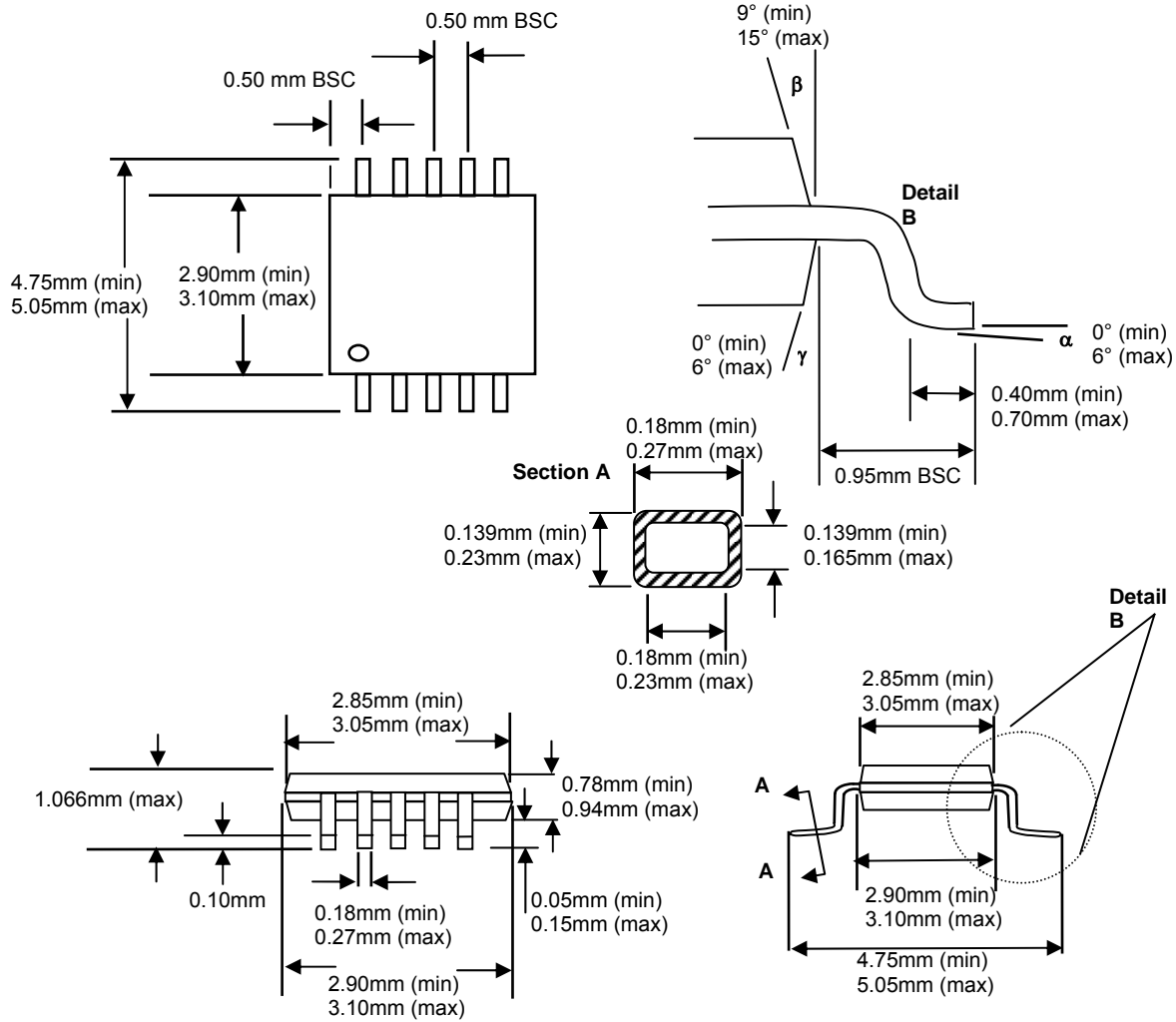



## Data Sheet Classifications

### Preliminary Specification

This classification is shown on the heading of each page of a specification for products that are either under development (design and qualification), or in the formative planning stages. Andigilog reserves the right to change or discontinue these products without notice.

### New Release Specification

This classification is shown on the heading of the first page only of a specification for products that are either under the later stages of development (characterization and qualification), or in the early weeks of release to production. Andigilog reserves the right to change the specification and information for these products without notice.

### Fully Released Specification

Fully released datasheets do not contain any classification in the first page header. These documents contain specification on products that are in full production. Andigilog will not change any guaranteed limits without written notice to the customers. Obsolete datasheets that were written prior to January 1, 2001 without any header classification information should be considered as obsolete and non-active specifications, or in the best case as Preliminary Specifications.

### Notes:

Pentium™ is a trademark of Intel Corporation

#### LIFE SUPPORT POLICY

ANDIGILOG'S PRODUCTS ARE NOT AUTHORIZED FOR USE AS CRITICAL COMPONENTS IN LIFE SUPPORT DEVICES OR SYSTEMS WITHOUT THE EXPRESS WRITTEN APPROVAL OF THE PRESIDENT AND GENERAL COUNSEL OF ANDIGILOG, INC. As used herein:

1. Life support devices or systems are devices or systems which, (a) are intended for surgical implant into the body, or (b) support or sustain life, and whose failure to perform when properly used in accordance with instructions for use provided in the labeling, can be reasonably expected to result in a significant injury to the user.
2. A critical component is any component of a life support device or system whose failure to perform can be reasonably expected to cause the failure of the life support device or system, or to affect its safety or effectiveness.

Andigilog, Inc.  
8380 S. Kyrene Rd., Suite 101  
Tempe, Arizona 85284  
Tel: (480) 940-6200  
Fax: (480) 940-4255