



Rated impedance 27 to 91 Ω
Rated current 3 and 4 A



Construction

- Size 0603 to 1806 (EIA)
or 1608 to 4516 (IEC)
- Ferrite core

Features

- Low dc resistance
- High rated current
- Available in various sizes
- Suitable for reflow (IR and vapor phase)
and wave soldering

Applications

Prevention of high-frequency EMI in

- computers, printers
- VCRs, TVs

Terminals

- Tinned
- Ni intermediate layer

Marking

No marking on component

Minimum marking on reel:

Manufacturer, part number, ordering code,
Z value and tolerance of Z value,
quantity, date of packing

Delivery mode

8- or 12-mm blister tape, reel packing

For details on taping, packing and packing units [see page 217](#)

General technical data

Impedance $ Z $	Measured with HP 4291A at frequency f_z
Rated current I_R	Maximum dc current at ambient temperature $T_A = 85^\circ\text{C}$
DC resistance R_{\max}	Measured at 20°C ambient temperature
Climatic category	In accordance with IEC 60068-1 25/085/21 ($-25^\circ\text{C}/+85^\circ\text{C}/21$ days damp heat test)
Storage temperature	$-25^\circ\text{C}/+85^\circ\text{C}$
Soldering:	
Wave soldering	Maximum 250°C , 5 s
Infrared soldering	Maximum 240°C , 20 s temperature/time profile $> 200^\circ\text{C}$, max. 50 s
Vapor-phase soldering	Maximum $(215 \pm 5)^\circ\text{C}$, max. 50 s
Solderability	$(230 \pm 5)^\circ\text{C}$, $(3 \pm 0,5)$ s wetting of soldering area: $\geq 90\%$
Resistance to soldering heat	$(260 \pm 5)^\circ\text{C}$, $(10 \pm 0,5)$ s after preheating at 150°C , 60 s impedance change max. $\pm 25\%$
Permissible PCB bending	2 mm (100 mm long standard PCB)
Temperature cycles	$-25^\circ\text{C}/+85^\circ\text{C}$, for each 30 min., total 5 cycles impedance change $\leq 25\%$
Humidity test	60°C , 90 to 95 % r. h., 500 h impedance change $\leq 25\%$
Life test	500 h at 85°C and rated current impedance change $\leq 25\%$

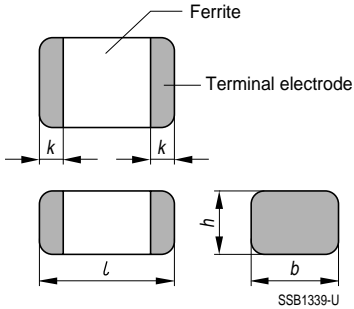
Dimensional drawing

Type	Size		Dimensions (mm)			
	EIA	IEC	<i>l</i>	<i>b</i>	<i>h</i>	<i>k</i>
B82482-A2	0603	1608	1,6 ± 0,2	0,8 ± 0,12	0,8 ± 0,2	(0,4)
B82483-A2	0805	2012	2,0 ± 0,2	1,25 ± 0,2	0,9 ± 0,2	(0,5)
B82485-A2	1206	3216	3,2 ± 0,3	1,6 ± 0,2	0,9 ± 0,2	(0,6)
B82487-A2	1806	4516	4,5 ± 0,3	1,6 ± 0,2	0,9 ± 0,2	(0,6)

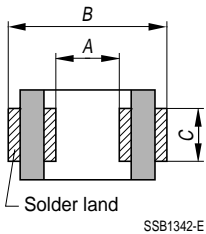
PCB layout recommendation

Type	Size		Dimensions (mm)		
	EIA	IEC	<i>A</i>	<i>B</i>	<i>C</i>
B82482-A2	0603	1608	0,6 ... 1,0	2,0 ... 3,0	0,8 ... 1,0
B82483-A2	0805	2012	0,8 ... 1,2	3,0 ... 4,0	1,0 ... 1,2
B82485-A2	1206	3216	1,6 ... 2,0	4,0 ... 5,0	1,2 ... 1,6
B82487-A2	1806	4516	2,6 ... 3,0	5,5 ... 6,5	1,2 ... 1,6

Characteristics and ordering codes

 For further technical data [see page 214](#)

Size EIA	IEC	Z Ω	Tolerance	<i>f</i> _Z MHz	<i>I</i> _R A	<i>R</i> _{max} mΩ	Ordering code
0603	1608	27	± 25 %	100	4	6	B82482-A2270-A
0805	2012	39	± 25 %	100	4	8	B82483-A2390-A
1206	3216	68	± 25 %	100	3	12	B82485-A2680-A
1806	4516	91	± 25 %	100	3	16	B82487-A2910-A



Typical electrical characteristics

Impedance $|Z|$, real part R and imaginary part X versus frequency f

————— $|Z|$ - - - - - R - - - - - X

Size 0603

B82482-A2270-A

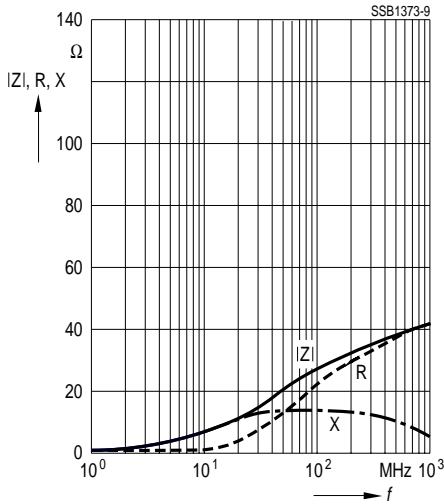

Size 0805

B82483-A2390-A

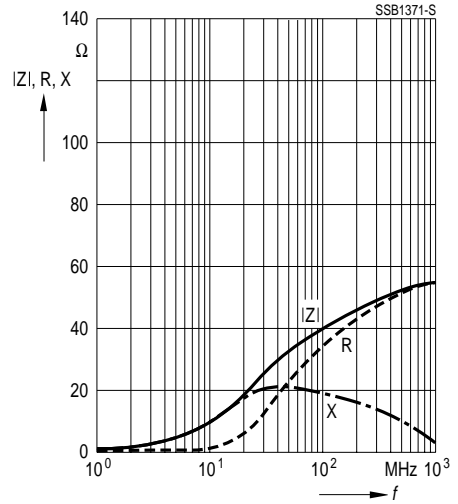

Size 1206

B82485-A2680-A

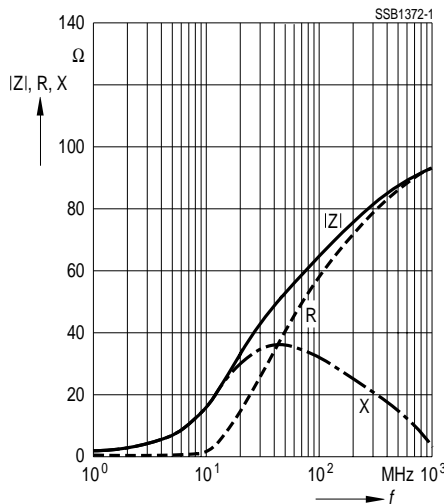

Size 1806

B82487-A2910-A

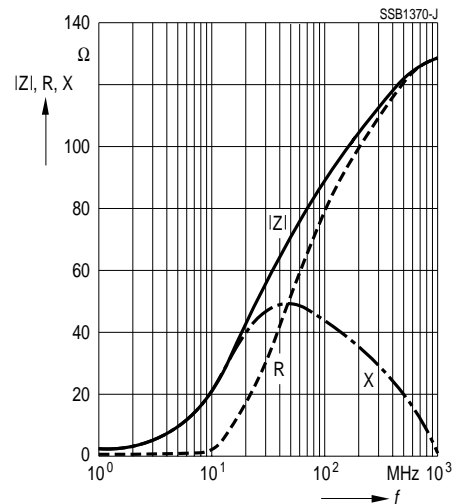

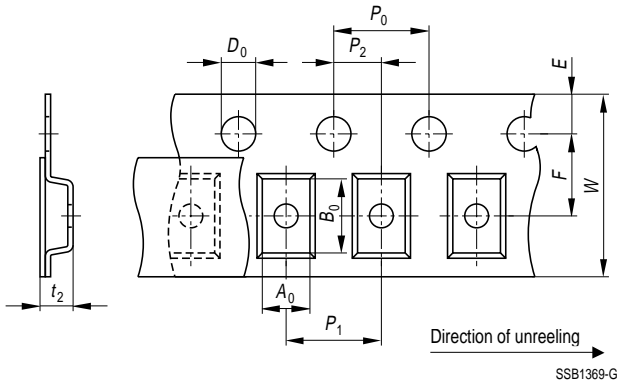
8- and 12-mm blister tape

Size (EIA)	0603	0805	1206	1806
Size (IEC)	1608	2012	3216	4516
Type	B82482-A2	B82483-A2	B82485-A2	B82487-A2
	Dimensions (mm)			
W	$8,0 \pm 0,2$	$8,0 \pm 0,2$	$8,0 \pm 0,2$	$12,0 \pm 0,2$
A_0	$2,1 \pm 0,2$	$2,3 \pm 0,2$	$3,5 \pm 0,2$	$4,8 \pm 0,2$
B_0	$1,1 \pm 0,2$	$1,5 \pm 0,2$	$1,9 \pm 0,2$	$1,9 \pm 0,2$
F	$3,5 \pm 0,1$	$3,5 \pm 0,1$	$3,5 \pm 0,1$	$5,5 \pm 0,1$
E	$1,75 \pm 0,1$	$1,75 \pm 0,1$	$1,75 \pm 0,1$	$1,75 \pm 0,1$
P_0	$4,0 \pm 0,1$	$4,0 \pm 0,1$	$4,0 \pm 0,1$	$4,0 \pm 0,1$
P_1	$4,0 \pm 0,1$	$4,0 \pm 0,1$	$4,0 \pm 0,1$	$8,0 \pm 0,1$
P_2	$2,0 \pm 0,1$	$2,0 \pm 0,1$	$2,0 \pm 0,1$	$2,0 \pm 0,1$
D_0	$1,5 + 0,1/- 0$	$1,5 + 0,1/- 0$	$1,5 + 0,1/- 0$	$1,5 + 0,1/- 0$
t_2	1,4 max.	1,4 max.	1,4 max.	1,4 max.

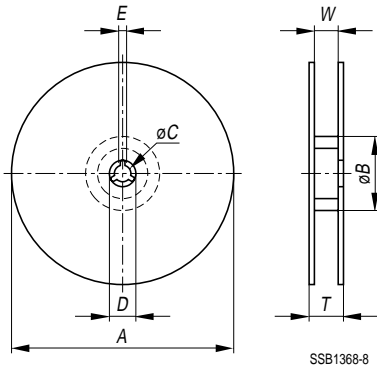
Reel packing

Size (EIA)	0603	0805	1206	1806
Size (IEC)	1608	2012	3216	4516
Type	B82482-A2	B82483-A2	B82485-A2	B82487-A2
Dimensions (mm)				
A	178,0 ± 2			
∅B	60,0 ± 1			
∅C	13,0 ± 0,5			
D	21,0 ± 0,8			
E	2,0 ± 0,5			
W	9,0 ± 0,3	9,0 ± 0,3	9,0 ± 0,3	13,0 ± 0,3
T	11,4 ± 1	11,4 ± 1	11,4 ± 1	15,4 ± 1

Packing units per reel (pieces)

	4000	4000	3000	3000
--	------	------	------	------