

巻線チップインダクタ

WOUND CHIP INDUCTORS

CB SERIES

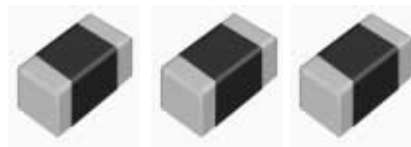

OPERATING TEMP. -25~+85°C

リフロー/REFLOW

特長 FEATURES

- ・超小型、大電流の巻線チップインダクタ
- ・実装性、特性において方向性のない形状
- ・DC/DCコンバーター回路向け

- ・ Small size wound chip inductor with high current.
- ・ Dimension without directional influence on mountability and characteristics.
- ・ For DC-DC converter circuit.

用途 APPLICATIONS

- ・ DVC, MD, PDA等の携帯AV機器, デジタル機器

- ・ DVC, MD, PDA and other portable digital equipment.

形名表記法 ORDERING CODE

1

形式	
CB	巻線チップインダクタ

3

外径寸法 (mm)	
2012(0805)	2.0×1.25
2016(0806)	2.0×1.6
2518(1007)	2.5×1.8
3225(1210)	3.2×2.5

5

公称インダクタンス (μH)	
例	
1R0	1
100	10
101	100

※R=小数点

6

インダクタンス許容差 (%)	
M	±20

2

形状	
△	低 Rdc
C	大電流
L	低背

4

包装	
T	テーピング

7

個別仕様	
△	標準品
R	低 RDC 品

8

当社管理記号	
△△△	標準品

△=スペース



1

Type	
CB	Wound chip inductor

3

External Dimensions (mm)	
2012(0805)	2.0×1.25
2016(0806)	2.0×1.6
2518(1007)	2.5×1.8
3225(1210)	3.2×2.5

5

Nominal Inductance (μH)	
example	
1R0	1
100	10
101	100

*R=decimal point

6

Inductance Tolerances (%)	
M	±20

2

Shape	
△	Low Rdc
C	High current Type
L	Low profile

4

Packaging	
T	Tape & Reel

7

Special code	
△	Standard products
R	Low Rdc type

8

Internal code	
△△△	Standard Products

△=Blank space

外形寸法 EXTERNAL DIMENSIONS

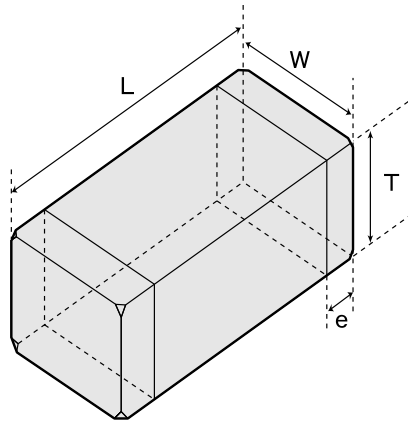

Type	L	W	T	E
CBC3225	3.2±0.3 (0.126±0.012)	2.5±0.3 (0.098±0.012)	2.5±0.3 (0.098±0.012)	0.6±0.3 (0.024±0.012)
CB2518 CBC2518	2.5±0.2 (0.098±0.008)	1.8±0.2 (0.071±0.008)	1.8±0.2 (0.071±0.008)	0.5±0.2 (0.020±0.008)
CB2016 CBC2016	2.0±0.2 (0.079±0.008)	1.6±0.2 (0.063±0.008)	1.6±0.2 (0.063±0.008)	0.5±0.2 (0.020±0.008)
CB2012 CBC2012	2.0±0.2 (0.079±0.008)	1.25±0.2 (0.049±0.008)	1.25±0.2 (0.049±0.008)	0.5±0.2 (0.020±0.008)
CBL2012	2.0±0.2 (0.079±0.008)	1.25±0.2 (0.049±0.008)	0.9±0.1 (0.035±0.004)	0.5±0.2 (0.020±0.008)

Unit mm(inch)

概略バリエーション AVAILABLE INDUCTANCE RANGE

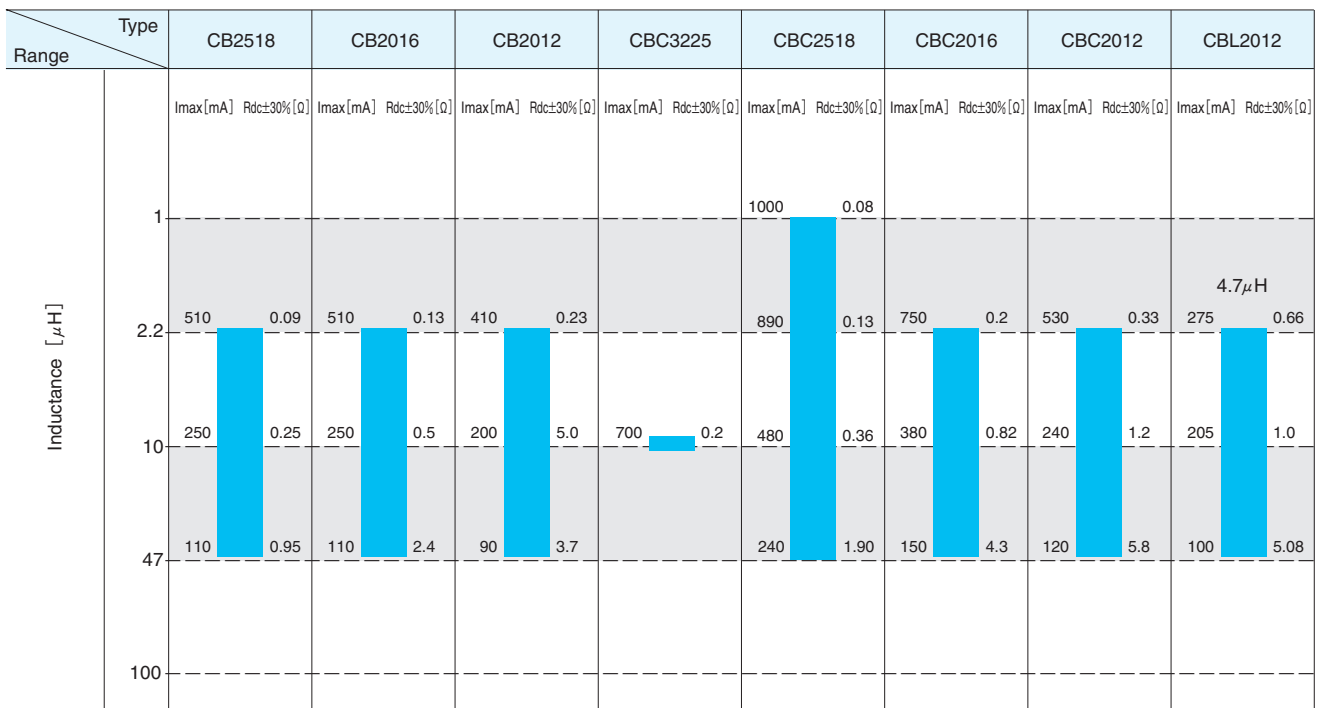

代表値 Examples	Inductance	Imax [mA]	Rdc±30% [Ω]	Imax [mA]	Rdc±30% [Ω]	Imax [mA]	Rdc±30% [Ω]	Imax [mA]	Rdc±30% [Ω]	Imax [mA]	Rdc±30% [Ω]	Imax [mA]	Rdc±30% [Ω]	Imax [mA]	Rdc±30% [Ω]	Imax [mA]	Rdc±30% [Ω]
	1μH	—	—	—	—	—	—	—	—	—	1000	0.08	—	—	—	—	—
2.2μH	510	0.09	510	0.13	410	0.23	—	—	890	0.13	750	0.2	530	0.33	275(4.7μH)	0.66(4.7μH)	
10μH	250	0.25	250	0.5	200	5.0	700	0.2	480	0.36	380	0.82	240	1.2	205	1.0	
47μH	110	0.95	110	2.4	90	3.7	—	—	240	1.9	150	4.3	120	5.8	100	5.08	
100μH	—	—	—	—	—	—	—	—	—	—	—	—	—	—	—	—	—

セクションガイド
Selection Guide



etc

アイテム一覧
Part Numbers



特性図
Electrical Characteristics



梱包
Packaging



信頼性
Reliability Data



使用上の注意
Precautions



CB2012 TYPE

形名 Ordering code	公称 インダクタンス Inductance [μH]	インダクタンス 許容差 Inductance Tolerance	自己共振 周波数 Self-resonant frequency [MHz] min.	直流抵抗 DC Resistance [Ω] (±30%)	定格電流 Rated current [mA] max.		測定 周波数 Measuring frequency [MHz]
					①	②	
CB 2012T2R2M	2.2	±20%	80	0.23	410	770	7.96
CB 2012T4R7M	4.7		45	0.40	300	580	
CB 2012T100MR	10		32	0.5	200	520	
CB 2012T220M	22		16	1.70	135	280	2.52
CB 2012T470M	47		11	3.70	90	190	

CB2016 TYPE

形名 Ordering code	公称 インダクタンス Inductance [μH]	インダクタンス 許容差 Inductance Tolerance	自己共振 周波数 Self-resonant frequency [MHz] min.	直流抵抗 DC Resistance [Ω] (±30%)	定格電流 Rated current [mA] max.		測定 周波数 Measuring frequency [MHz]
					①	②	
CB 2016T2R2M	2.2	±20%	70	0.13	510	1000	7.96
CB 2016T4R7M	4.7		45	0.25	340	740	
CB 2016T100M	10		32	0.5	250	520	
CB 2016T220M	22		16	1.0	165	370	2.52
CB 2016T470M	47		11	2.4	110	240	

CB2518 TYPE

形名 Ordering code	公称 インダクタンス Inductance [μH]	インダクタンス 許容差 Inductance Tolerance	自己共振 周波数 Self-resonant frequency [MHz] min.	直流抵抗 DC Resistance [Ω] (±30%)	定格電流 Rated current [mA] max.		測定 周波数 Measuring frequency [MHz]
					①	②	
CB 2518T2R2M	2.2	±20%	68	0.09	510	1300	7.96
CB 2518T4R7M	4.7		46	0.13	340	1100	
CB 2518T100M	10		30	0.25	250	820	
CB 2518T220M	22		19	0.50	165	580	2.52
CB 2518T470M	47		12	0.95	110	420	

CBC2012 TYPE

形名 Ordering code	公称 インダクタンス Inductance [μH]	インダクタンス 許容差 Inductance Tolerance	自己共振 周波数 Self-resonant frequency [MHz] min.	直流抵抗 DC Resistance [Ω] (±30%)	定格電流 Rated current [mA] max.		測定 周波数 Measuring frequency [MHz]
					①	②	
CB C2012T2R2M	2.2	±20%	70	0.33	530	640	7.96
CB C2012T4R7M	4.7		45	0.50	360	520	
CB C2012T100M	10		40	1.20	240	340	
CB C2012T220M	22		16	3.70	170	190	2.52
CB C2012T470M	47		11	5.80	120	150	

CBC2016TYPE

形名 Ordering code	公称 インダクタンス Inductance [μH]	インダクタンス 許容差 Inductance Tolerance	自己共振 周波数 Self-resonant frequency [MHz] min.	直流抵抗 DC Resistance [Ω] (±30%)	定格電流 Rated current [mA] max.		測定 周波数 Measuring frequency [MHz]
					①	②	
CB C2016T2R2M	2.2	±20%	70	0.20	750	720	7.96
CB C2016T4R7M	4.7		45	0.37	550	530	
CB C2016T100M	10		40	0.82	380	410	
CB C2016T220M	22		16	1.80	250	240	2.52
CB C2016T470M	47		11	4.30	150	150	

※一般的な小型パワーチョークコイルの定格電流としては上表の定格電流①を参考にして下さい。
 ※定格電流②は、DC/DCコンバータの突入電流のような、瞬時であれば通電可能な電流値です。
 自動復帰回路等を備え、半連続的に5分以上、大電流が通電する様な回路でご利用される場合には弊社営業に御相談下さい。
 定格電流①：公称インダクタンスの-30%を保證する電流値
 定格電流②：通電した時に部品温度がΔT=40℃以内であることを保證する電流値（インダクタンス値を保證する電流ではありません）

※For rated current of ordinary small power choke coils, please refer to the rated current ① in the above table.
 ※Rated current ② is the current for instantaneous flow such as plugging current of DC/DC converter.
 In case of usage in the circuit where large current may be semicontinuously applied over 5 minutes with auto recovery circuit, etc., please contact our sales section before practical application.
 Rated current ① : Current value to guarantee -30% of nominal inductance
 Rated current ② : Current value to guarantee component temperature within ΔT=40℃ with current flow.
 (It is not the current to guarantee the inductance value.)

CBC2518 TYPE

形名 Ordering code	公称 インダクタンス Inductance [μH]	インダクタンス 許容差 Inductance Tolerance	自己共振 周波数 Self-resonant frequency [MHz] min.	直流抵抗 DC Resistance [Ω] (±30%)	定格電流 Rated current [mA] max.		測定 周波数 Measuring frequency [MHz]
					①	②	
CB C2518T1R0M	1.0	±20%	100	0.08	1000	1200	7.96
CB C2518T2R2M	2.2		68	0.13	890	1100	
CB C2518T4R7M	4.7		41	0.20	680	920	
CB C2518T100M	10		30	0.36	480	680	2.52
CB C2518T220M	22		19	0.77	320	460	
CB C2518T470M	47		12	1.90	240	290	

CBC3225 TYPE

形名 Ordering code	公称 インダクタンス Inductance [μH]	インダクタンス 許容差 Inductance Tolerance	自己共振 周波数 Self-resonant frequency [MHz] min.	直流抵抗 DC Resistance [Ω] (±30%)	定格電流 Rated current [mA] max.		測定 周波数 Measuring frequency [MHz]
					①	②	
CB C3225T100M	10	±20%	8	0.2	700	760	0.1

CBL2012 TYPE

形名 Ordering code	公称 インダクタンス Inductance [μH]	インダクタンス 許容差 Inductance Tolerance	自己共振 周波数 Self-resonant frequency [MHz] min.	直流抵抗 DC Resistance [Ω] (±30%)	定格電流 Rated current [mA] max.		測定 周波数 Measuring frequency [MHz]
					①	②	
CB L2012T4R7M	4.7	±20%	45	0.69	275	490	0.1
CB L2012T100M	10		32	1.09	205	370	
CB L2012T470M	47		11	5.08	100	140	

※一般的な小型パワーチョークコイルの定格電流としては上表の定格電流①を参考にして下さい。
 ※定格電流②は、DC/DCコンバータの突入電流のような、瞬時であれば通電可能な電流値です。
 自動復帰回路等を備え、半連続的に5分間以上、大電流が通電する様な回路でご利用される場合には弊社営業に御相談下さい。
 定格電流①：公称インダクタンスの-30%を保証する電流値
 定格電流②：通電した時に部品温度がΔT=40℃以内であることを保証する電流値（インダクタンス値を保証する電流ではありません）

※For rated current of ordinary small power choke coils, please refer to the rated current ① in the above table.
 ※Rated current ② is the current for instantaneous flow such as plunging current of DC/DC converter.
 In case of usage in the circuit where large current may be semicontinuously applied over 5 minutes with auto recovery circuit, etc., please contact our sales section before practical application.
 Rated current ① : Current value to guarantee -30% of nominal inductance
 Rated current ② : Current value to guarantee component temperature within ΔT=40℃ with current flow.
 (It is not the current to guarantee the inductance value.)

直流重畳特性例 DC Bias characteristics (Measured by HP4285A+42841A)

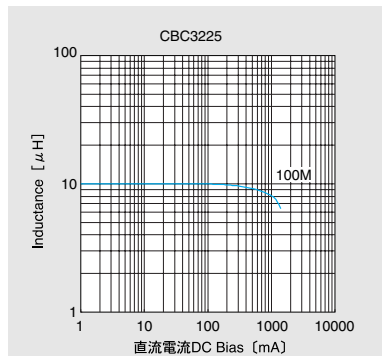
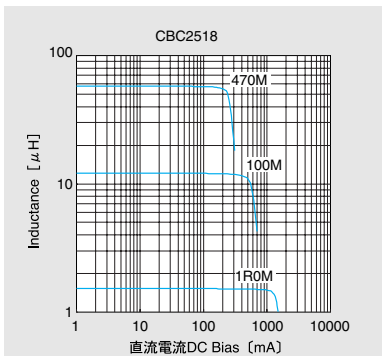
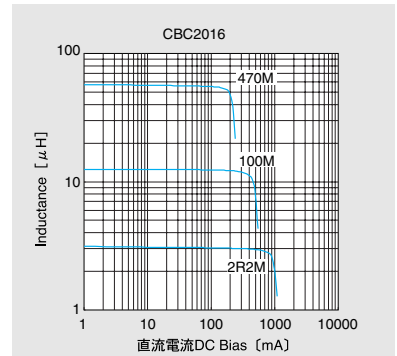
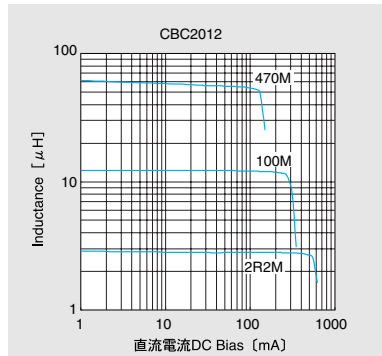
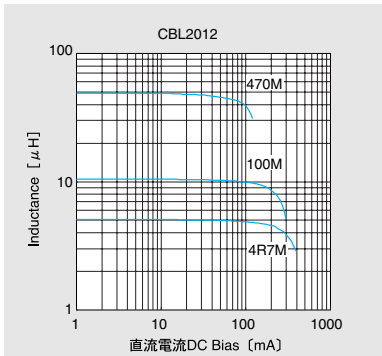
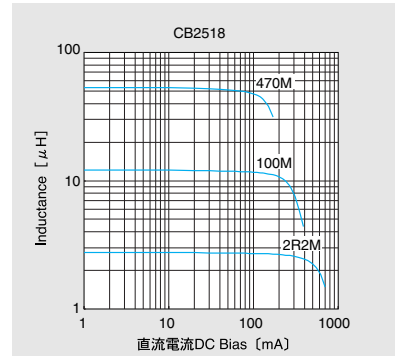
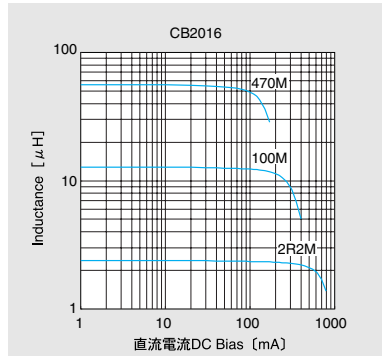
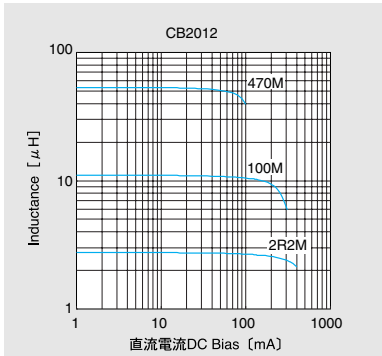

インピーダンス周波数 Impedance-vs-Frequency characteristics (Measured by HP4291A)

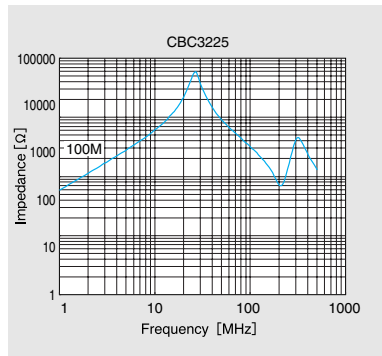
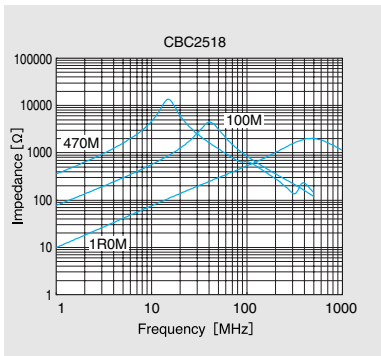
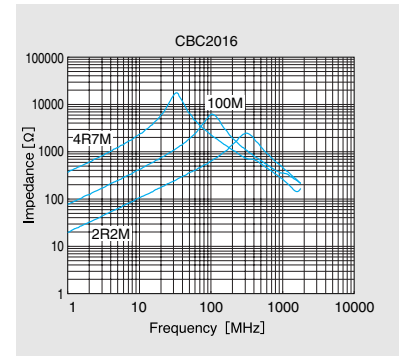
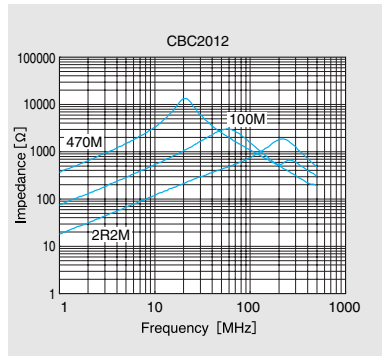
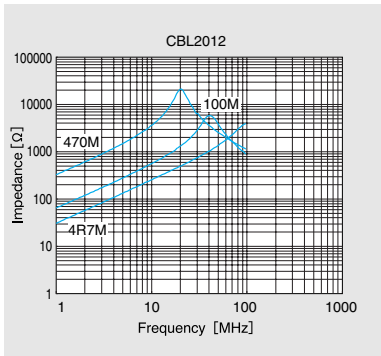
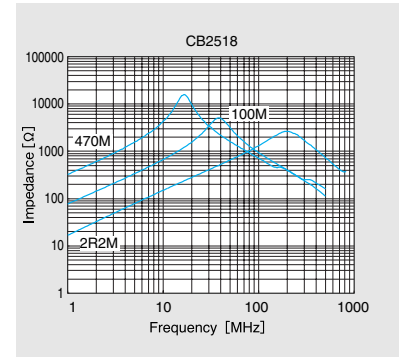
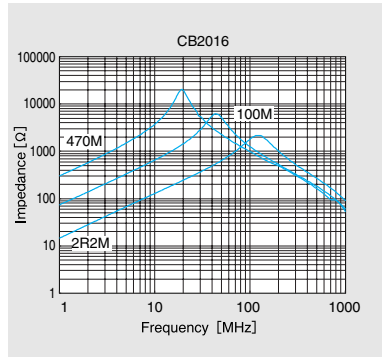
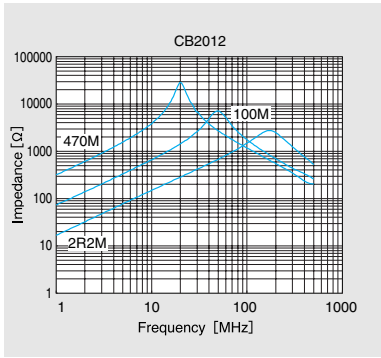

①最小受注単位数 Minimum Quantity

形式 Type	標準数量 Standard Quantity [pcs]
	テーピング Tape&Reel
LB2518 / LBC2518 CB2518 / CBC2518	2000
LB2016 / LBC2016 CB2016 / CBC2016	2000
LB2012 / LBC2012 CB2012 / CBC2012	3000
LBH1608 / LB1608	4000
CBC3225	1000
CBL2012	4000

形式 Type	チップ挿入部 Chip Cavity		挿入ピッチ Insertion Pitch	テープ厚み Tape Thickness	
	A	B	F	K	T
LB2518 / CB2519 LBC2518 / CBC2519	2.15±0.1 (0.085±0.004)	2.7±0.1 (0.107±0.004)	4.0±0.1 (0.157±0.004)	2.1 (0.083)	0.3 (0.012)
LB2016 / LBC2016 CB2016 / CBC2016	1.9±0.1 (0.075±0.004)	2.2±0.1 (0.087±0.004)	4.0±0.1 (0.157±0.004)	2.15 (0.085)	0.3 (0.012)
LB2012 / LBC2012 CB2012 / CBC2012	1.5±0.2 (0.059±0.008)	2.3±0.2 (0.091±0.008)	4.0±0.1 (0.157±0.004)	2.0 (0.079)	0.3 (0.012)
LBH1608 LB1608	1.0±0.2 (0.059±0.008)	1.8±0.2 (0.091±0.008)	4.0±0.1 (0.157±0.004)	1.1max (0.079)	1.1max (0.012)
CBC3225	2.8±0.2 (0.110±0.008)	3.5±0.2 (0.138±0.008)	4.0±0.2 (0.157±0.003)	4.0max (0.157)	0.6max (0.024)
CBL2012	1.55±0.2 (0.061±0.008)	2.3±0.2 (0.091±0.008)	4.0±0.1 (0.157±0.004)	1.1max (0.079)	1.1max (0.079)

Unit: mm (inch)

②テーピング材質 Tape material

エンボステープ Embossed tape
紙テープ(LBH1608) Card board carrier tape(LBH1608)

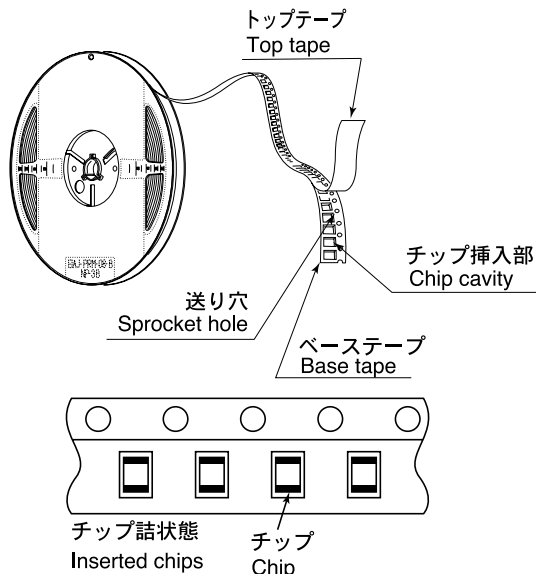

④リーダー部/空部 Leader and Blank Portion

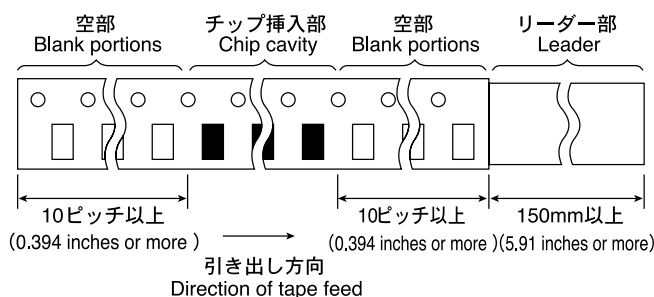

⑤リール寸法 Reel Size

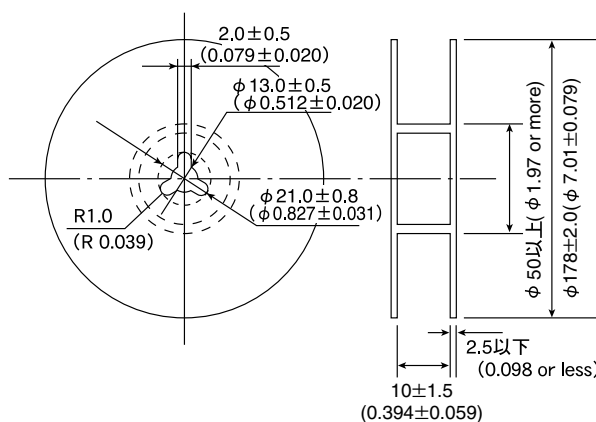

③テーピング寸法 Taping Dimensions

エンボステープ (8mm幅) Embossed Tape (0.315 inches wide)
紙テープ (8mm幅) Paper tape (0.315 inches wide)

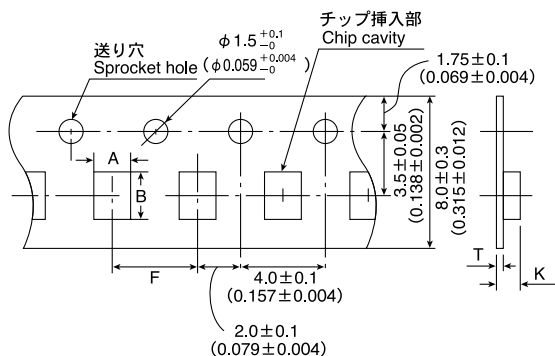

⑥トップテープ強度 Top Tape Strength

トップテープのはがし力は、下図矢印方向にて0.2~0.7Nとなります。
The top tape requires a peel-off force of 0.2 to 0.7N in the direction of the arrow as illustrated below.

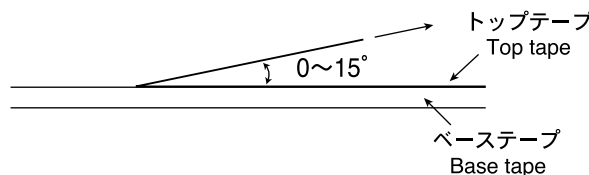

Item	Specified Value							Test Methods and Remarks
	LEM2520	LB2518 LB2016 LB2012 LB1608	LBC2518 LBC2016 LBC2012	CB2518 CB2016 CB2012	CBC3225 CBC2518 CBC2016 CBC2012	CBL2012	LBH1608	
1. Operating temperature Range	-40~+85°C	-25~+85°C						
2. Storage	-40~+85°C	-25~+85°C						
3. Rated Current	Within the specified tolerance							<p>LEM · LB · LBC Series The maximum DC value having inductance decrease within 10% and temperature increases within 20°C by the application of DC bias.</p> <p>CB · CBC · CBL Series The maximum DC value having inductance decrease within 30% and temperature increases within 40°C by the application of DC bias.</p> <p>LBH1608: The maximum DC value having temperature increases within 20°C by the application of DC bias.</p>
4. Inductance	Within the specified tolerance							<p>YLEM Series 5N6VR10 : Measuring equipment : Impedance analyzer (HP4291A or its equivalent) Measuring frequency : Specified frequency</p> <p>LEM Series R12~221 : Measuring equipment : LCR Meter (HP4285A+42851A or its equivalent) Measuring frequency : Specified frequency</p> <p>LB · LBC · CB · CBC · CBL Series : Measuring equipment : LCR Meter (HP4285A or its equivalent)</p> <p>LBH1608 Series : Measuring equipment : Impedance analyzer (HP4291A or its equivalent)</p>
5. Q	Within the specified tolerance	/				12~18 (at 100MHz) min	<p>LEM Series R12~221 : Measuring equipment : LCR Meter (HP4285A+42851A or its equivalent) Measuring frequency : Specified frequency</p> <p>LBH1608 Series : Measuring equipment : Impedance analyzer (HP4291A or its equivalent)</p>	
6. DC Resistance	Within the specified tolerance							<p>LEM · LB · LBC · CB · CBC · CBL · LBH Series : Measuring equipment : low ohmmeter (A&D AD5812 or its equivalent)</p>

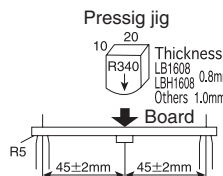
Item	Specified Value							Test Methods and Remarks												
	LEM2520	LB2518 LB2016 LB2012 LB1608	LBC2518 LBC2016 LBC2012	CB2518 CB2016 CB2012	CBC3225 CBC2518 CBC2016 CBC2012	CBL2012	LBH1608													
7. Self-Resonant Frequency	Within the specified tolerance							LEM2520 : Measuring equipment : Network analyzer (Anritsu MS620J or its equivalent) LB · LBC · CB · CBC · CBL Series : Measuring equipment : Impedance analyzer (HP4291A or its equivalent) LBH1608 Series : Measuring equipment : Network analyzer (HP8720B or its equivalent)												
8. Temperature Characteristic	$\Delta L/L \rightarrow$ Within $\pm 5\%$	$\Delta L/L \rightarrow$ Within $\pm 15\%$	2518 2016 $\Delta L/L \rightarrow$ Within $\pm 20\%$ 2012 $\Delta L/L \rightarrow$ Within $\pm 30\%$	$\Delta L/L \rightarrow$ Within $\pm 15\%$	3225 2518 2016 $\Delta L/L \rightarrow$ Within $\pm 20\%$ 2012 $\Delta L/L \rightarrow$ Within $\pm 30\%$	$\Delta L/L \rightarrow$ Within $\pm 15\%$	$\Delta L/L \rightarrow$ Within $\pm 5\%$ ※ $\Delta L/L \rightarrow$ Within $\pm 0.5nH$ under 8.2nH	Change of maximum inductance deviation in step 1-5 * Exclude CM03MS series <table border="1"> <thead> <tr> <th>Step</th> <th>Temperature (°C)</th> </tr> </thead> <tbody> <tr> <td>1</td> <td>20</td> </tr> <tr> <td>2</td> <td>-25</td> </tr> <tr> <td>3</td> <td>20 (Reference temperature)</td> </tr> <tr> <td>4</td> <td>+85 (Maximum operating temperature)</td> </tr> <tr> <td>5</td> <td>20</td> </tr> </tbody> </table>	Step	Temperature (°C)	1	20	2	-25	3	20 (Reference temperature)	4	+85 (Maximum operating temperature)	5	20
Step	Temperature (°C)																			
1	20																			
2	-25																			
3	20 (Reference temperature)																			
4	+85 (Maximum operating temperature)																			
5	20																			
9. Resistance to Flexure of Substrate	No breakdown or damage							Warp: 2mm (LBC, LB, CB, CBC, CBL, LBH Series) : 3mm (LEM2520) Test substrate: Printed board According to JIS C0051 Pressig jig 												
10. Body Strength	No breakdown or damage							Applide force : 15N Duration : 5sec. LB · LBC · CB · CBC · CBL · LBH · LEM2520 Applide force : 10N Duration : 10sec. LB1608 Applide force : 5N Duration : 10sec.												
11. Self Resonant Frequency	$\Delta L/L \rightarrow$ Within -10%			$\Delta L/L \rightarrow$ Within -30%			$\Delta L/L \rightarrow$ Within -10%	Measure inductance with application of rated current using LCR metre to compare it with the initial value. (* Excluding 5N6~R10)												

Item	Specified Value							Test Methods and Remarks
	LEM2520	LB2518 LB2016 LB2012 LB1608	LBC2518 LBC2016 LBC2012	CB2518 CB2016 CB2012	CBC3225 CBC2518 CBC2016 CBC2012	CBL2012	LBH1608	
12. Adhesion of terminal electrode	Shall not come off PC board.							LB · LBC · CB · CBC · CBL · LBH · LEM2520 Applied force : 10N to X and Y directions Duration : 5 sec. Test substrate : Printed board
13. Resistance to vibration	$\Delta L/L \rightarrow$ Within $\pm 5\%$ No significant abnormality in appearance.	$\Delta L/L \rightarrow$ Within $\pm 10\%$ No significant abnormality in appearance.	No significant abnormality in appearance.				LEM · LB · LBC · CB · CBC · CBL : According to JIS C5102 clause 8.2. Vibration type : A Directions : 2 hrs each in X, Y and Z directions. Total : 6 hrs Frequency range : 10 to 55 to 10 Hz (1min.) Amplitude : 1.5mm Mounting method : Soldering onto printed board (* Excluding 5N6-R10 LE Series) Recovery : At least 1 hr of recovery under the standard condition after the test, followed by the measurement within 2 hrs.	

Item	Specified Value							Test Methods and Remarks
	LEM2520	LB2518 LB2016 LB2012 LB1608	LBC2518 LBC2016 LBC2012	CB2518 CB2016 CB2012	CBC3225 CBC2518 CBC2016 CBC2012	CBL2012	LBH1608	
14.Drop test	<p>△L/L→ Within±5% No significant abnormality in appearance.</p>							<p>LEM : Drop test Impact material : concreta or vinyl tile Height : 1m Total number of drops : 10 times</p> <p>LEM2520 Acceleration : 980m/sec² Duration : 6msec Number of times : 6 sides × 3 times Mounting method : Soldering onto printed board (* Excluding 10N~R10)</p> <p>Recovery : At least 1 hr of recovery under the standard condition after the test, followed by the measurement within 2 hrs.</p>
15.Solderability	At least 90% of electrode							<p>LEM : Solder temperature : 230±5°C Duration : 5±0.5sec. (LEM2520) Fiux : Methanol solution with 25% of colophony</p> <p>LB · LBC · CB · CBC · CBL · LBH : Solder temperature : 230±5°C Duration : 5±0.5sec Fiux : Methanol solution with 25% of colophony</p>

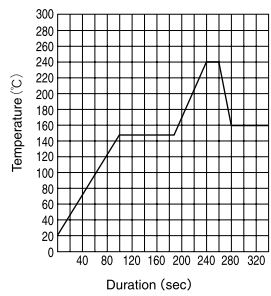
Item	Specified Value							Test Methods and Remarks
	LEM2520	LB2518 LB2016 LB2012 LB1608	LBC2518 LBC2016 LBC2012	CB2518 CB2016 CB2012	CBC3225 CBC2518 CBC2016 CBC2012	CBL2012	LBH1608	
16.Resistance to soldering heat	No significant abnormality in appearance							<p>Conduct following wave soldering twice.</p>  <p>Solder temperature : 260±5°C Duration : 5±0.5sec. Twice 10±1sec. Once (LEM2520)</p> <p>LB · LBC · CB · CBC · CBL · LBH : 3 times of reflow oven at 220 ± 5°C for 40sec.with peak temperature at 235± 5°C for 5sec.</p>
17.Resistance to solvent	No significant abnormality in appearance.							<p>Solvent temperature : Room temperature Type of solvent : Chlorocarbon type (LEM2520) Isopropyl alcohol (LB · LBC · CB · CBC · CBL)</p> <p>Cleaning conditions : Output : 20mW/cm² Frequency : 28kHz Duration : 1 min Conduct ultrasonic cleaning. (LEM2520) 90s. Immersion and cleaning. (LB · LBC)</p>

Item	Specified Value							Test Methods and Remarks									
	LEM2520	LB2518 LB2016 LB2012 LB1608	LBC2518 LBC2016 LBC2012	CB2518 CB2016 CB2012	CBC3225 CBC2518 CBC2016 CBC2012	CBL2012	LBH1608										
18. Thermal shock	$\Delta/L \rightarrow$ Within $\pm 10\%$ $Q \rightarrow$ 10N : 10min. 12N~33N : 15min. 39N~R10 : 20min. R12~4R7 : 30min. 5R6~330 : 25min. 390~820 : 20min. 101 : 15min.	$\Delta/L \rightarrow$ Within $\pm 10\%$					$\Delta/L \rightarrow$ Within $\pm 5\%$ ※ $\Delta/L \rightarrow$ within $\pm 0.5nH$ under 8.2 n H $\Delta/Q/Q \rightarrow$ within $\pm 20\%$ ※ $\Delta/Q/Q \rightarrow$ within ± 5 under 8.2 n H	Conditions for 1cycle <table border="1"> <thead> <tr> <th>Step</th> <th>Temperature(C)</th> <th>Duration(min)</th> </tr> </thead> <tbody> <tr> <td>1</td> <td>-40</td> <td>30</td> </tr> <tr> <td>2</td> <td>+85</td> <td>30</td> </tr> </tbody> </table> Temperature for : LEM2520 Number of cycle : 100 cycle Recovery : At least 1 hr of recovery the standard condition after the removal from test chamber, followed by measurement within 2 hrs. LB · LBC · CB · CBC · CBL · LBH : -40~+85°C, maintain times 30min. ,100 cycle Recovery : At least 1 hr of recovery under the standard condition after the test, followed by the measurement within 2 hrs.	Step	Temperature(C)	Duration(min)	1	-40	30	2	+85	30
Step	Temperature(C)	Duration(min)															
1	-40	30															
2	+85	30															
19. Damp heat	$\Delta/L \rightarrow$ Within $\pm 10\%$ $Q \rightarrow$ 10N : 10min. 12N~33N : 15min. 39N~R10 : 20min. R12~4R7 : 30min. 5R6~330 : 25min. 390~820 : 20min. 101 : 15min.	$\Delta/L \rightarrow$ Within $\pm 10\%$					$\Delta/L \rightarrow$ Within $\pm 5\%$ ※ $\Delta/L \rightarrow$ within $\pm 0.5nH$ under 8.2 n H $\Delta/Q/Q \rightarrow$ Within $\pm 20\%$ ※ $\Delta/Q/Q \rightarrow$ within ± 5 under 8.2 n H	Temperature : 60 \pm 2°C Humidity : 90~95%RH Duration : 1000 hrs Recovery : At least 1 hr of recovery the standard condition after the removal from test chamber, followed by measurement within 2 hrs.									

Item	Specified Value							Test Methods and Remarks
	LEM2520	LB2518 LB2016 LB2012 LB1608	LBC2518 LBC2016 LBC2012	CB2518 CB2016 CB2012	CBC3225 CBC2518 CBC2016 CBC2012	CBL2012	LBH1608	
20.Loading under damp heat	$\Delta L/L \rightarrow$ Within $\pm 10\%$ $Q \rightarrow$ R12~4R7 : 30min. 5R6~330 : 25min. 390~820 : 20min. 101 : 15min.	$\Delta L/L \rightarrow$ Within $\pm 10\%$					$\Delta L/L \rightarrow$ Within $\pm 5\%$ ※ $\Delta L/L \rightarrow$ within $\pm 0.5nH$ under 8.2 n H $\Delta Q/Q \rightarrow$ within $\pm 20\%$ ※ $\Delta Q/Q \rightarrow$ within ± 5 under 8.2 n H	LEM · LB · LBC · CB · CBC · CBL : Temperature : $60 \pm 2^\circ C$ (Excluding nH range) Humidity : 90~95%RH Duration : 1000 hrs Applied current : Rated current Recovery : At least 1 hr of recovery the standard condition after the removal from test chamber, followed by measurement within 2 hrs.
21.High temperature life test	$\Delta L/L \rightarrow$ Within $\pm 10\%$ $Q \rightarrow$ 10N : 10min. 12N~33N : 15min. 39N~R10 : 20min. R12~4R7 : 30min. 5R6~330 : 25min. 390~820 : 20min. 101 : 15min.	$\Delta L/L \rightarrow$ Within $\pm 10\%$					$\Delta L/L \rightarrow$ Within $\pm 5\%$ ※ $\Delta L/L \rightarrow$ within $\pm 0.5nH$ under 8.2 n H $\Delta Q/Q \rightarrow$ Within $\pm 20\%$ ※ $\Delta Q/Q \rightarrow$ within ± 0.5 under 8.2 n H	LEM · CB · CBC · CBL : Temperature : $85 \pm 2^\circ C$ Duration : 1000 hrs Recovery : At least 1 hr of recovery the standard condition after the removal from test chamber, followed by measurement within 2 hrs.
22.Loading at high temperature		$\Delta L/L \rightarrow$ Within $\pm 10\%$					$\Delta L/L \rightarrow$ Within $\pm 5\%$ ※ $\Delta L/L \rightarrow$ within $\pm 0.5nH$ under 8.2 n H $\Delta Q/Q \rightarrow$ Within $\pm 20\%$ ※ $\Delta Q/Q \rightarrow$ within ± 0.5 under 8.2 n H	LB · LBC : Temperature : $85 \pm 2^\circ C$ (Excluding nH range) Duration : 1000 hrs Applied current : Rated current Recovery : At least 1 hr of recovery the standard condition after the removal from test chamber, followed by measurement within 2 hrs.

Item	Specified Value							Test Methods and Remarks
	LEM2520	LB2518 LB2016 LB2012 LB1608	LBC2518 LBC2016 LBC2012	CB2518 CB2016 CB2012	CBC3225 CBC2518 CBC2016 CBC2012	CBL2012	LBH1608	
23.Low temperature life test	△L/L→ Within±10% Q→ 10N : 10min. 12N~33N : 15min. 39N~R10 : 20min. R12~4R7 : 30min. 5R6~330 : 25min. 390~820 : 20min. 101 : 15min.	△L/L→Within±10%					△L/L→ Within±5% ※△L/L→ within±0.5nH under 8.2 n H △Q/Q→ Within±20% ※△Q/Q→ within±5 under 8.2 n H	LEM · LB · LBC · CB · CBC · CBL · LBH Temperature : -40±2°C Duration : 1000 hrs Recovery : At least 1 hr of recovery the standard condition after the removal from test chamber, followed by measurement within 2 hrs.
24.Standard condition	"Standard condition" referred to herein defined as follows : 5 to 35 °C of temperature, 45 to 85% relative humidity, and 86 to 106kPa of air pressure. When there are questions concerning measurement results : In order to provide correlation data, the test shall be conducted under condition of 20±2°C of temperature, 45 to 85% to 106kPa of air pressure. Unless otherwise specified all the test are conducted under the "standard condition"	Standard test condition : Unless otherwise specified, Temperature 20±15°C of temperature, 65±20% of relative humidity. When there are question concerning measurement result : In order to provide correlation date, the test shall be condition of 20±2°C of tenterature, 65±5% relative humidity. Inductance is in accordance with our measured value.						

PRECAUTIONS

LEM Type, LB Type, CB Type

Stages	Precautions	Technical considerations
1.Circuit Design	<p>Operating environment,</p> <p>1.The products described in this specification are intended for use in general electronic equipment,(office supply equipment, telecommunications systems, measuring equipment, and household equipment). They are not intended for use in mission-critical equipment or systems requiring special quality and high reliability (traffic systems, safety equipment, aerospace systems, nuclear control systems and medical equipment including life-support systems,) where product failure might result in loss of life, injury or damage. For such uses, contact TAIYO YUDEN Sales Department in advance.</p>	
2.PCB Design	<p>Land pattern design</p> <p>1.Please contact any of our offices for a land pattern, and refer to a recommended land pattern of specifications.</p>	
3.Considerations for automatic placement	<p>Adjustment of mounting machine</p> <p>1.Excessive impact load should not be imposed on the products when mounting onto the PC boards.</p> <p>2.Mounting and soldering conditions should be checked beforehand.</p>	<p>1. When installing products, care should be taken not to apply distortion stress as it may deform the products.</p>
4.Soldering	<p>Wave soldering</p> <p>1.Please refer to the specifications in the catalog for a wave soldering.</p> <p>Reflow soldering</p> <p>1.Please contact any of our offices for a reflow soldering, and refer to the recommended condition specified.</p> <p>2.LB Type, CB Type</p> <p>Reflow solderring only.</p> <p>Lead free soldering</p> <p>1.When using products with lead free soldering, we request to use them after confirming of adhesion, temperature of resistance to soldering heat, etc. sufficiently.</p> <p>Recommended conditions for using a soldering iron</p> <p>Put the soldering iron on the land-pattern.</p> <p>Soldering iron's temperature - Below 350 °C</p> <p>Duration - 3 seconds or less</p> <p>The soldering iron should not directly touch the inductor.</p>	<p>1.If products are used beyond the range of the recommended conditions, heat stresses may deform the products, and consequently degrade the reliability of the products.</p>
5.Cleaning	<p>Cleaning conditions</p> <p>LB Type, CB Type</p> <p>1.Washing by supersonic waves shall be avoided.</p>	<p>LB Type, CB Type</p> <p>1.If washing by supersonic waves, supersonic waves may cause broken products.</p>
6.Handling	<p>Handling</p> <p>1.Keep the inductors away from all magnets and magnetic objects.</p> <p>Breakaway PC boards (splitting along perforations)</p> <p>1.When splitting the PC board after mounting inductors, care should be taken not to give any stresses of deflection or twisting to the board.</p> <p>2.Board separation should not be done manually, but by using the appropriate devices.</p> <p>Mechanical considerations</p> <p>1.Please do not give the inductors any excessive mechanical shocks.</p>	<p>1.There is a case that a characteristic varies with magnetic influence.</p> <p>1.Planning pattern configurations and the position of products should be carefully performed to minimize stress.</p> <p>1.There is a case to be damaged by a mechanical shock.</p>
7.Storage conditions	<p>Storage</p> <p>1.To maintain the solderability of terminal electrodes and to keep the packing material in good condition, temperature and humidity in the storage area should be controlled.</p> <p>· Recommended conditions</p> <p>Ambient temperature 0~40°C</p> <p>Humidity Below 70% RH</p> <p>The ambient temperature must be kept below 30°C Even under ideal storage conditions, solderability of products electrodes may decrease as time passes. For this reason, LE type inductors should be used within one year from the time of delivery.</p> <p>LB type</p> <p> Please should be used within 6 months from the time of delivery.</p> <p>LE type</p> <p> In case of storage over 6 months, solderability shall be checked before actual usage.</p>	<p>1. Under a high temperature and humidity environment, problems such as reduced solderability caused by oxidation of terminal electrodes and deterioration of taping/packaging materials may take place.</p>