

CEPFZ44/CEBFZ44

March 1998

N-Channel Enhancement Mode Field Effect Transistor

4

FEATURES

- 55V , 60A , $R_{DS(ON)}=25m\Omega$ @ $V_{GS}=10V$
- Super high dense cell design for extremely low $R_{DS(ON)}$.
- High power and current handling capability.
- TO-220 & TO-263 package.

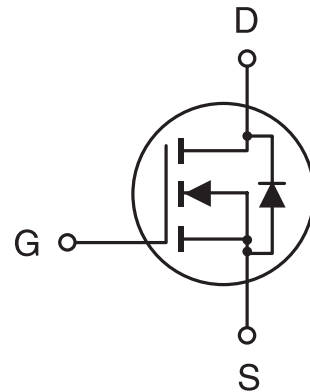

ABSOLUTE MAXIMUM RATINGS (Tc=25°C unless otherwise noted)

Parameter	Symbol	Limit	Unit
Drain-Source Voltage	V _{DS}	55	V
Gate-Source Voltage	V _{GS}	±20	V
Drain Current-Continuous -Pulsed	I _D	60	A
	I _{DM}	144	A
Drain-Source Diode Forward Current	I _S	60	A
Maximum Power Dissipation @T _c =25°C Derate above 25°C	P _D	100	W
		0.7	W/°C
Operating and Storage Temperature Range	T _J , T _{STG}	-65 to 175	°C

THERMAL CHARACTERISTICS

Thermal Resistance, Junction-to-Case	R _{θJC}	2	°C/W
Thermal Resistance, Junction-to-Ambient	R _{θJA}	62.5	°C/W

CEPFZ44/CEBFZ44

4

ELECTRICAL CHARACTERISTICS (Tc=25°C unless otherwise noted)

Parameter	Symbol	Condition	Min	Typ	Max	Unit
OFF CHARACTERISTICS						
Drain-Source Breakdown Voltage	BV _{DSS}	V _{GS} =0V, I _D =250μA	55			V
Zero Gate Voltage Drain Current	I _{DSS}	V _{DS} =55V, V _{GS} =0V			25	μA
Gate-Body Leakage	I _{GSS}	V _{GS} =±20V, V _{DS} =0V			±100	nA
ON CHARACTERISTICS^a						
Gate Threshold Voltage	V _{GS(th)}	V _{DS} =V _{GS} , I _D =250μA	2	2.8	4	V
Drain-Source On-State Resistance	R _{DS(ON)}	V _{GS} =10V, I _D =24A		19	25	mΩ
On-State Drain Current	I _{D(ON)}	V _{GS} =10V, V _{DS} =10V	60			A
Forward Transconductance	g _{FS}	V _{DS} =10V, I _D =24A		20		S
DYNAMIC CHARACTERISTICS^b						
Input Capacitance	C _{ISS}	V _{DS} =25V, V _{GS} =0V f=1.0MHz		1178	1600	pF
Output Capacitance	C _{OSS}			428	560	pF
Reverse Transfer Capacitance	C _{RSS}			95	130	pF
SWITCHING CHARACTERISTICS^b						
Turn-On Delay Time	t _{D(ON)}	V _{DD} =30V, I _D =48A, V _{GS} =10V, R _{GEN} =7.5Ω		15	20	ns
Rise Time	t _r			250	300	ns
Turn-Off Delay Time	t _{D(OFF)}			45	60	ns
Fall Time	t _f			60	150	ns
Total Gate Charge	Q _g	V _{DS} =48V, I _D =48A, V _{GS} =10V		35	70	nC
Gate-Source Charge	Q _{gs}			12		nC
Gate-Drain Charge	Q _{gd}			7		nC

CEPFZ44/CEBFZ44

ELECTRICAL CHARACTERISTICS (T_c=25°C unless otherwise noted)

4

Parameter	Symbol	Condition	Min	Typ	Max	Unit
DRAIN-SOURCE DIODE CHARACTERISTICS ^a						
Diode Forward Voltage	V _{SD}	V _{GS} = 0V, I _S =24A		0.9	1.3	V

Notes

- a. Pulse Test: Pulse Width ≤300 μs, Duty Cycle ≤2%.
- b. Guaranteed by design, not subject to production testing.

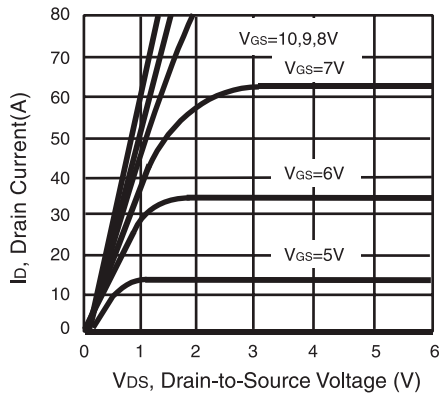

Figure 1. Output Characteristics

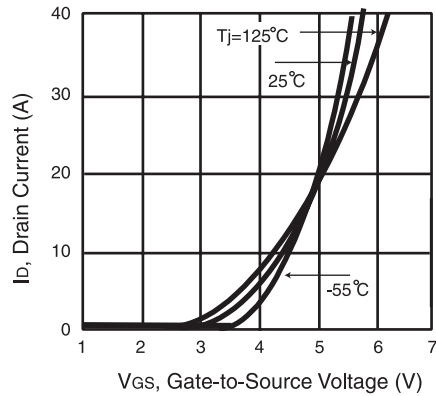

Figure 2. Transfer Characteristics

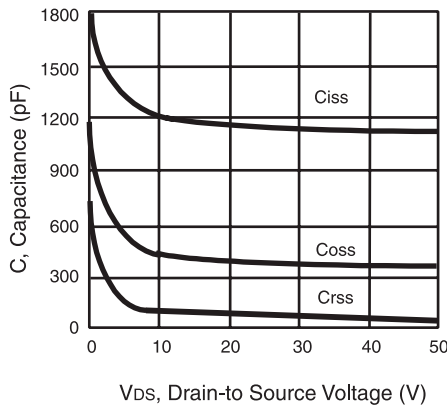

Figure 3. Capacitance

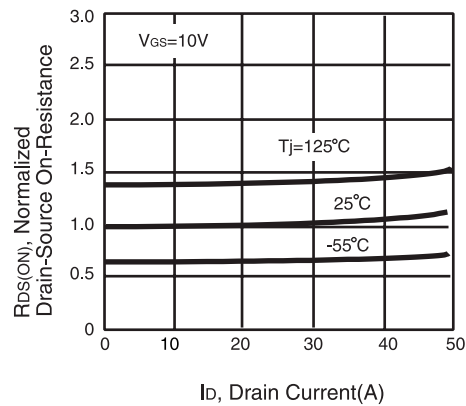

Figure 4. On-Resistance Variation with Drain Current and Temperature

CEPFZ44/CEBFZ44

4

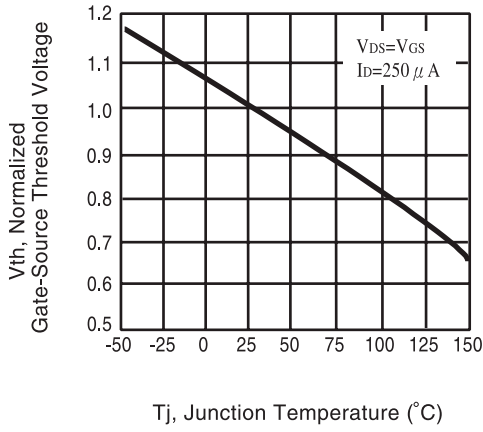

Figure 5. Gate Threshold Variation with Temperature

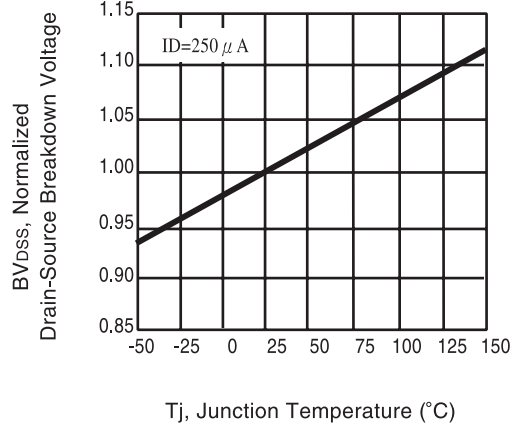

Figure 6. Breakdown Voltage Variation with Temperature

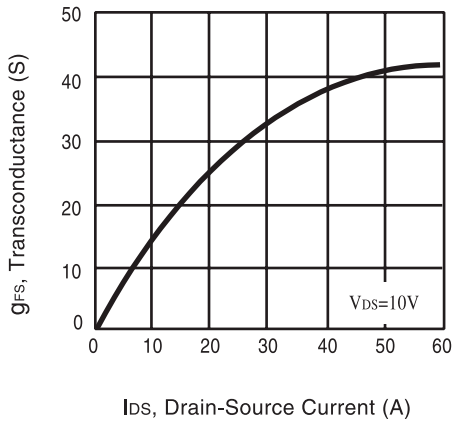

Figure 7. Transconductance Variation with Drain Current

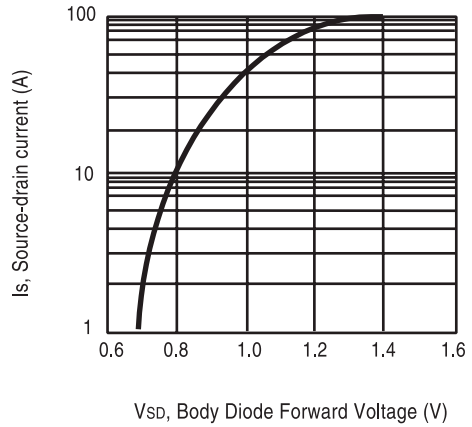

Figure 8. Body Diode Forward Voltage Variation with Source Current

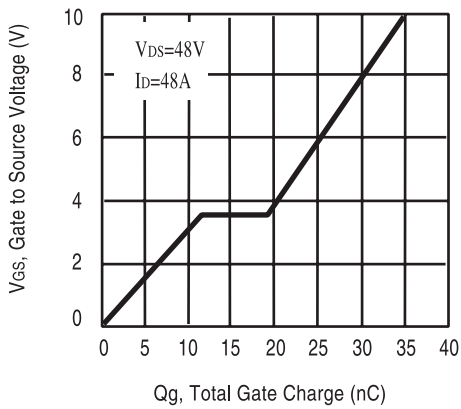

Figure 9. Gate Charge

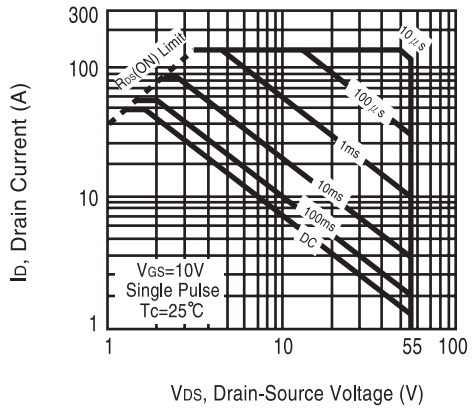

Figure 10. Maximum Safe Operating Area

CEPFZ44/CEBFZ44

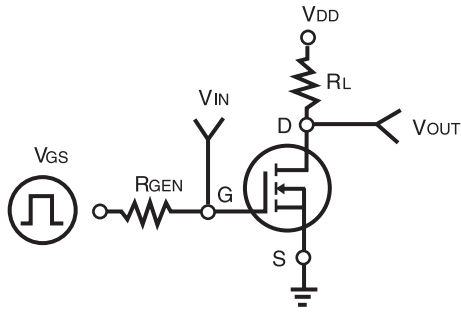

Figure 11. Switching Test Circuit

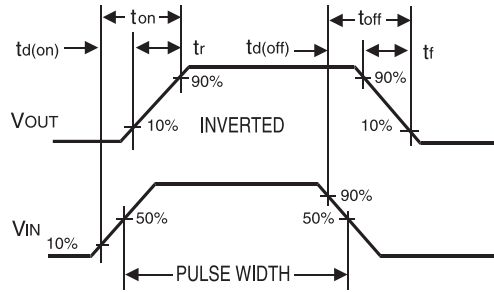

Figure 12. Switching Waveforms

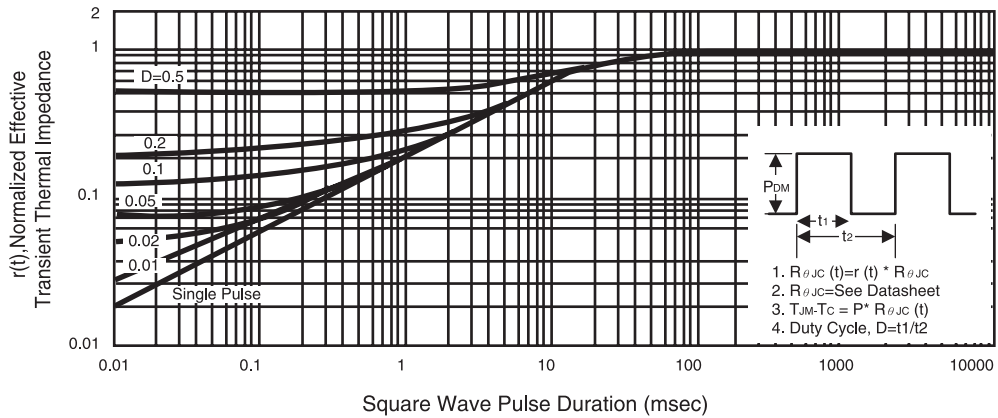

Figure 13. Normalized Thermal Transient Impedance Curve