

Features

- 300 Watts Peak Pulse Power ($t_p = 8 \times 20 \mu s$)
- Transient Protection for data line to IEC61000-4-2 level 4 (ESD), 8kV HBM, and IEC 61000-4-4 (EFT)
- Low Leakage Current
- Surface Mount Package Ideally Suited for Automatic Insertion
- **Lead Free/RoHS Compliant (Note 4)**

Mechanical Data

- Case: SOT-23
- Case Material: Molded Plastic. UL Flammability Classification Rating 94V-0
- Moisture Sensitivity: Level 1 per J-STD-020C
- Terminals: Solderable per MIL-STD-202, Method 208
- Lead Free Plating (Matte Tin Finish annealed over Alloy 42 leadframe).
- Terminal Connections: See Diagram
- Part Marking (See Page 3): A01
- Ordering & Date Code Information: Page 3
- Weight: 0.008 grams (approximate)

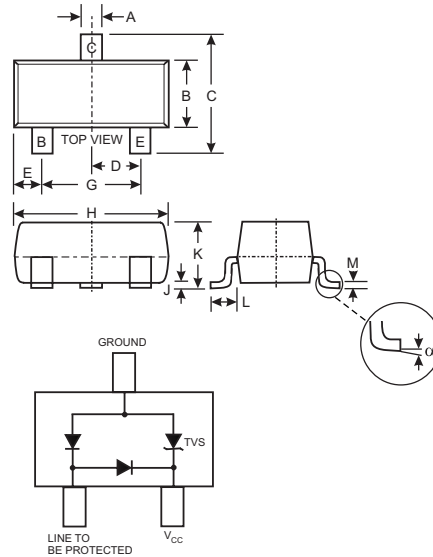

SOT-23		
Dim	Min	Max
A	0.37	0.51
B	1.20	1.40
C	2.30	2.50
D	0.89	1.03
E	0.45	0.60
G	1.78	2.05
H	2.80	3.00
J	0.013	0.10
K	0.903	1.10
L	0.45	0.61
M	0.085	0.180
α	0°	8°
All Dimensions in mm		

Maximum Ratings, Total Device @ $T_A = 25^\circ C$ unless otherwise specified

Characteristic	Symbol	Value	Unit
Peak Pulse Power ($t_p = 8 \times 20 \mu s$)	P_{PK}	300	W
Peak Forward Voltage ($I_{PP} = 1A, t_p = 8 \times 20 \mu s$)	V_{FP}	2.1	V
Diode Peak Repetitive Reverse Voltage	V_{RRM}	75	V
Thermal Resistance, Junction to Ambient	$R_{\theta JA}$	417	$^\circ C/W$
Operating and Storage Temperature Range	T_j, T_{STG}	-55 to +150	$^\circ C$

Electrical Characteristics, TVS Element @ $T_A = 25^\circ C$ unless otherwise specified

Reverse Standoff Voltage	Breakdown Voltage V_{BR} @ I_T		Test Current	Max. Reverse Leakage @ V_{RWM}	Max. Clamping Voltage @ $I_{PP} = 1A$ (Note 3)	Max. Peak Pulse Current (Note 2)	Typical Total Capacitance (Note 1)
	V_{RWM} (V)	Min (V)					
5	6	—	1.0	20	9.8	17	1.9

- Notes:
1. $V_R = 0V, f = 1MHz$ from line to be protected to ground pin.
 2. $t_p = 8 \times 20 \mu s$.
 3. Clamping voltage values are based on an $8 \times 20 \mu s$ peak pulse current (I_{PP}) waveform.
 4. No purposefully added lead.

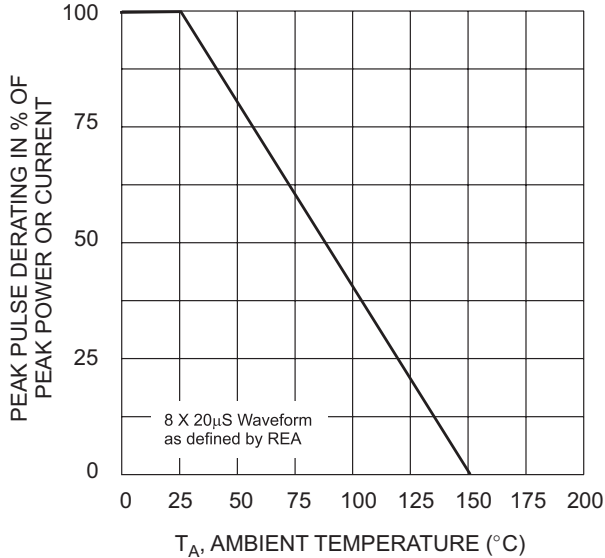

Fig. 1 Pulse Derating Curve

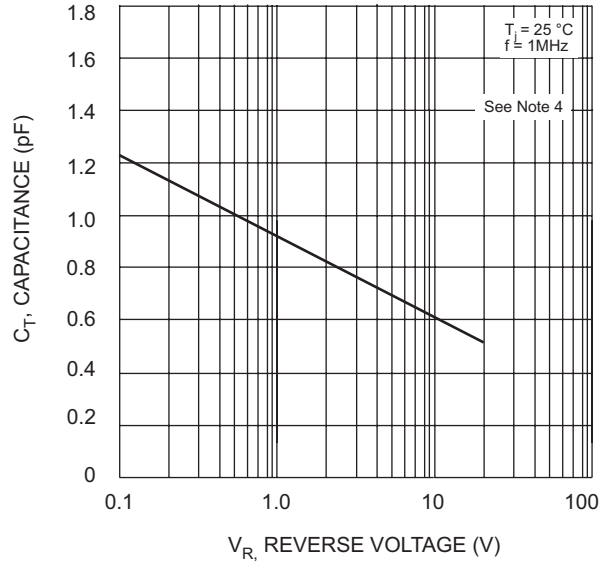

Fig. 2 Typical Total Capacitance vs Reverse Voltage

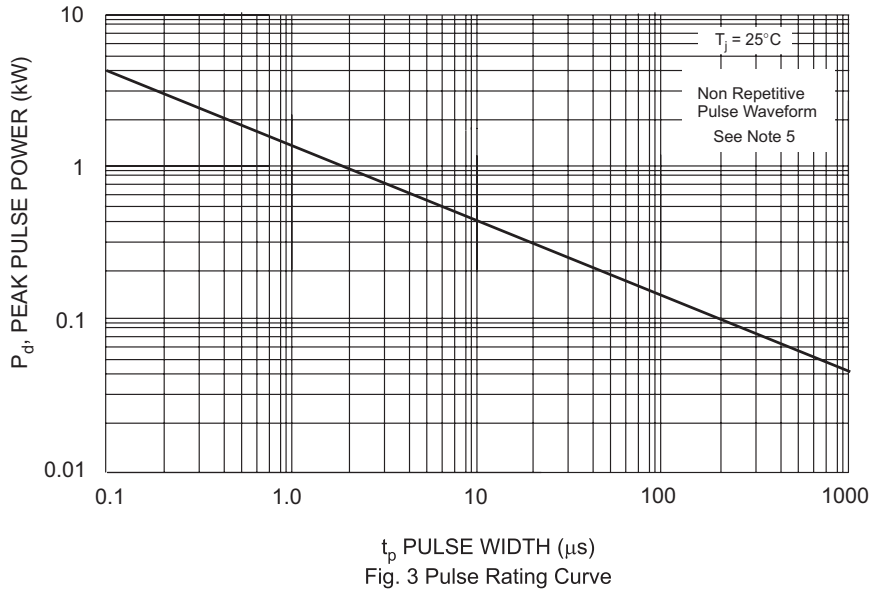

Fig. 3 Pulse Rating Curve

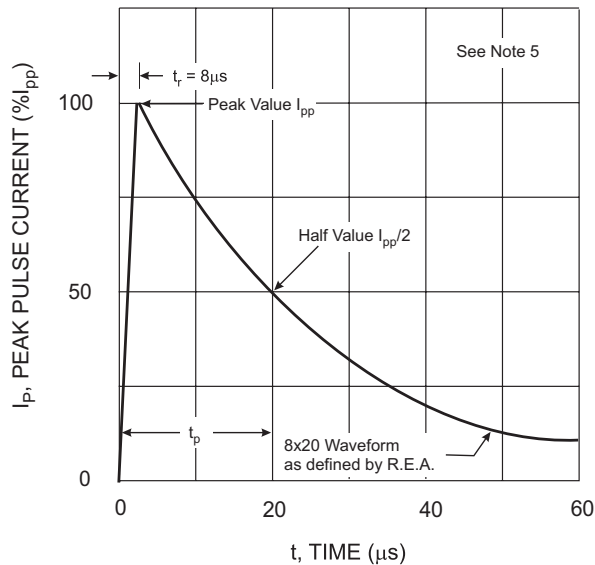

Fig. 4 Pulse Waveform

Notes: 5. Measured from line to be protected to ground pin.
6. Curves apply to TVS element of device.

Ordering Information (Note 7)

Device	Packaging	Shipping
DLPT05-7-F	SOT-23	3000/Tape & Reel

Notes: 7. For Packaging Details, go to our website at <http://www.diodes.com/datasheets/ap02007.pdf>.

Marking Information

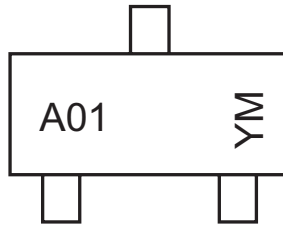

A01 = Product Type Marking Code
 YM = Date Code Marking
 Y = Year ex: N = 2002
 M = Month ex: 9 = September

Date Code Key

Year	1998	1999	2000	2001	2002	2003	2004	2005	2006	2007	2008	2009
Code	J	K	L	M	N	P	R	S	T	U	V	W

Month	Jan	Feb	March	Apr	May	Jun	Jul	Aug	Sep	Oct	Nov	Dec
Code	1	2	3	4	5	6	7	8	9	O	N	D

Typical Application Schematics

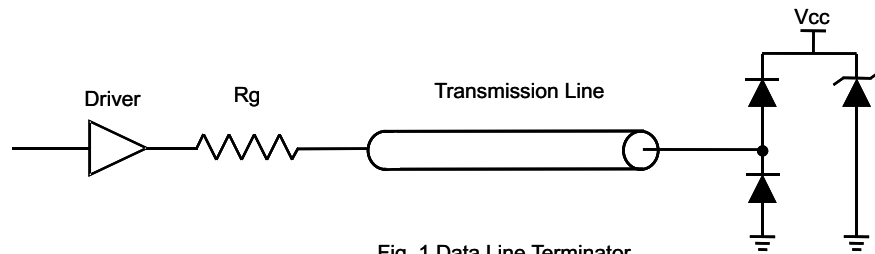

Fig. 1 Data Line Terminator

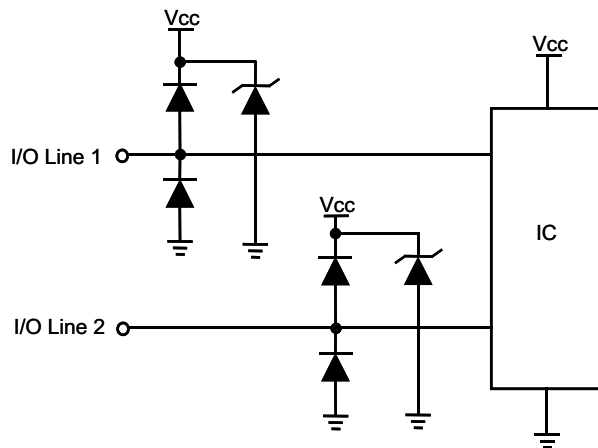

Fig. 2 Data Line Protection

IMPORTANT NOTICE

Diodes, Inc. and its subsidiaries reserve the right to make changes without further notice to any product herein to make corrections, modifications, enhancements, improvements, or other changes. Diodes, Inc. does not assume any liability arising out of the application or use of any product described herein; neither does it convey any license under its patent rights, nor the rights of others. The user of products in such applications shall assume all risks of such use and will agree to hold Diodes Incorporated and all the companies whose products are represented on our website, harmless against all damages.

LIFE SUPPORT

The products located on our website at www.diodes.com are not recommended for use in life support systems where a failure or malfunction of the component may directly threaten life or cause injury without the expressed written approval of Diodes Incorporated.