

**3-TERMINAL 1A ADJUSTABLE VOLTAGE REGULATOR****AZ317****General Description**

The AZ317 is an adjustable three-terminal positive voltage regulator with a very low dropout of 1.2V at 1A output current. Using 2 external resistors, the AZ317 can provide an adjustable output voltage down to 1.25V.

The AZ317 includes a circuit of trimmed bandgap reference to assure output voltage accuracy to be within 1%. It also provides current limiting and thermal shutdown. The current limit is trimmed to ensure specified output current and controlled short-circuit current. The On-chip thermal limiting provides protection against any combination of overload and ambient temperature that would create excessive junction temperature.

The AZ317 is available in the standard SOT-223, TO-220-3, TO-252-2 (1) and TO-263-3 power packages.

Features

- Typical 1% Output Voltage Tolerance
- Typical 0.01%/V Line Regulation
- Typical 0.2% Load Regulation
- Very Low Dropout Voltage: 1.2V at 1A Output Current
- Trimmed Current Limit
- On-chip Thermal Protection
- Operation Junction Temperature: 0 to 125°C

Applications

- PC Motherboard
- LCD Monitor
- Graphic Card
- DVD Player
- Network Interface Card/Switch
- Telecom Equipment
- Printer and other Peripheral Equipment

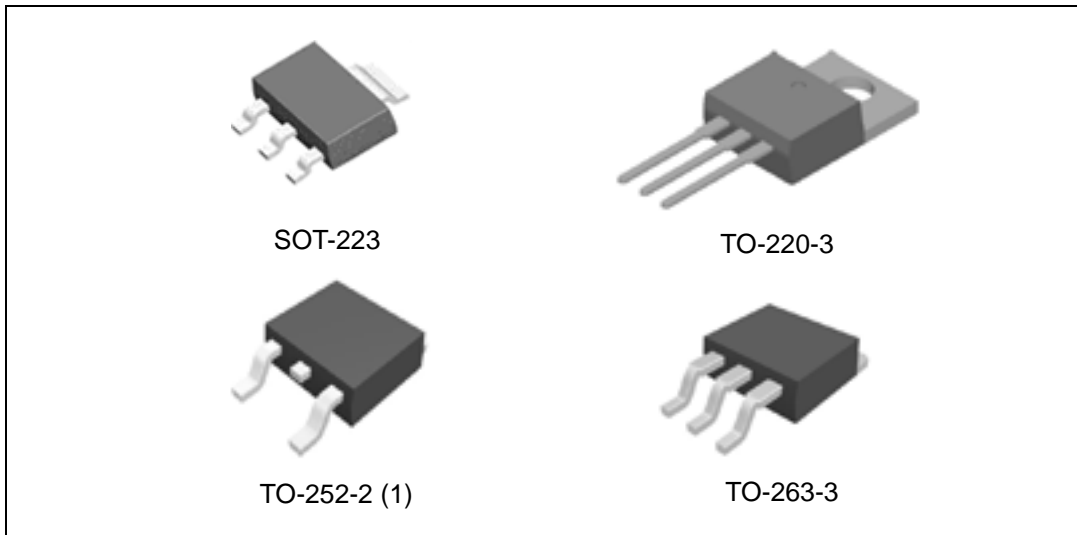

Figure 1. Package Types of AZ317



3-TERMINAL 1A ADJUSTABLE VOLTAGE REGULATOR

AZ317

Pin Configuration

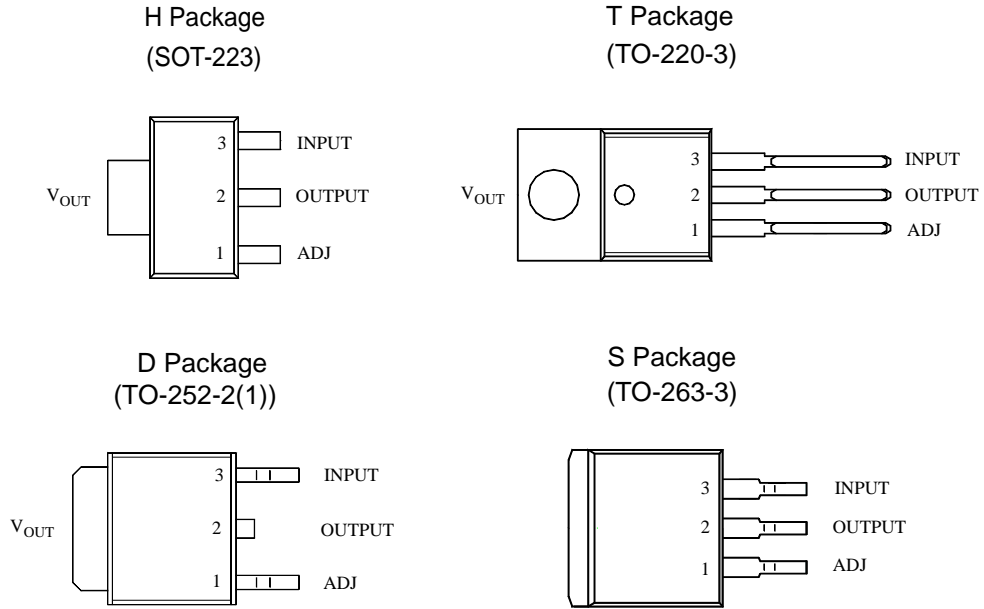

Figure 2. Pin Configuration of AZ317 (Top View)

Functional Block Diagram

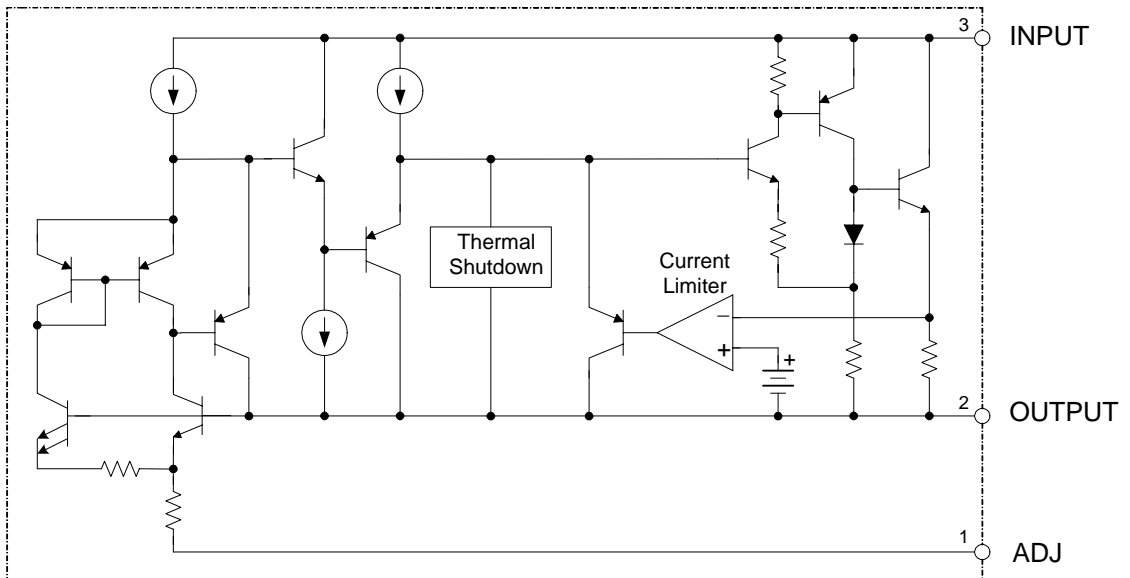

Figure 3. Functional Block Diagram of AZ317



3-TERMINAL 1A ADJUSTABLE VOLTAGE REGULATOR

AZ317

Ordering Information

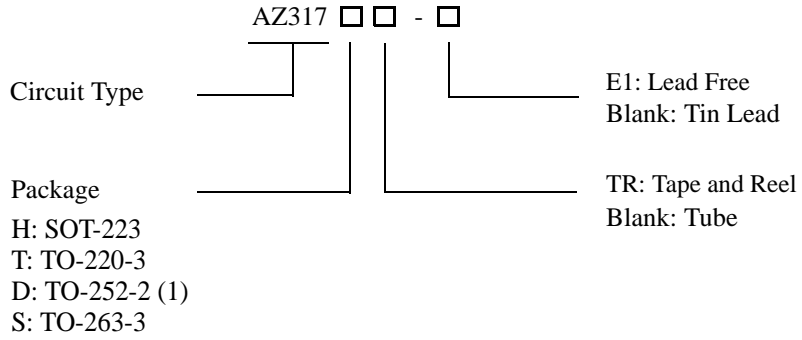

Package	Temperature Range	Part Number		Marking ID		Packing Type
		Tin Lead	Lead Free	Tin Lead	Lead Free	
SOT-223	0 to 125°C	AZ317HTR	AZ317HTR-E1	317H	EH31A	Tape & Reel
TO-220-3	0 to 125°C	AZ317T	AZ317T-E1	AZ317T	AZ317T-E1	Tube
TO-252-2 (1)	0 to 125°C	AZ317D	AZ317D-E1	AZ317D	AZ317D-E1	Tube
		AZ317DTR	AZ317DTR-E1	AZ317D	AZ317D-E1	Tape & Reel
TO-263-3	0 to 125°C	AZ317S	AZ317S-E1	AZ317S	AZ317S-E1	Tube
		AZ317STR	AZ317STR-E1	AZ317S	AZ317S-E1	Tape & Reel

BCD Semiconductor's Pb-free products, as designated with "E1" suffix in the part number, are RoHS compliant.

**3-TERMINAL 1A ADJUSTABLE VOLTAGE REGULATOR****AZ317****Absolute Maximum Ratings (Note 1)**

Parameter	Symbol	Min	Max	Unit
Input Voltage	V_{IN}		20	V
Maximum Junction Temperature	T_J		150	°C
Storage Temperature	T_S	-65	150	°C
Lead Temperature (Soldering, 10sec)	T_{LEAD}		300	°C
ESD (Human Body Model)	ESD		4000	V

Note1: Stresses greater than those listed under "Absolute Maximum Ratings" may cause permanent damage to the device. These are stress ratings only, and functional operation of the device at these or any other conditions beyond those indicated under "Recommended Operating Conditions" is not implied. Exposure to "Absolute Maximum Ratings" for extended periods may affect device reliability.

Recommended Operating Conditions

Parameter	Symbol	Min	Max	Unit
Input Voltage	V_{IN}	$V_{OUT}+2$	15	V
Operating Junction Temperature Range	T_J	0	125	°C

**3-TERMINAL 1A ADJUSTABLE VOLTAGE REGULATOR****AZ317****Electrical Characteristics**(Typicals and limits apply for $T_J = 25^\circ\text{C}$, $P \leq$ Maximum Power Dissipation unless otherwise specified.)(Note 2)

Parameter	Symbol	Conditions	Min	Typ	Max	Unit
Reference Voltage	V_{REF}	$10\text{mA} \leq I_{OUT} \leq 1\text{A}$, $3\text{V} \leq (V_{IN} - V_{OUT}) \leq 10\text{V}$	1.20	1.25	1.30	V
Line Regulation	S_V	$I_{OUT} \leq 20\text{mA}$, $3\text{V} \leq V_{IN} - V_{OUT} \leq 10\text{V}$		0.01	0.04	%/V
Load Regulation	S_i	$V_{IN} - V_{OUT} = 2\text{V}$, $10\text{mA} \leq I_{OUT} \leq 1\text{A}$		0.2	0.4	%
Thermal Regulation		20ms Pulse		0.04	0.07	%/W
Dropout Voltage	ΔV	$I_{OUT} = 1\text{A}$		1.2	1.3	V
Current Limit	I_{LIMIT}	$(V_{IN} - V_{OUT}) = 2\text{V}$	1.2	1.5	1.8	A
Adjust Pin Current				50	100	μA
Adjust Pin Current Change		$1.4\text{V} \leq (V_{IN} - V_{OUT}) \leq 10\text{V}$, $10\text{mA} \leq I_{OUT} \leq 1\text{A}$		0.2	5	μA
Minimum Load Current		$3\text{V} \leq (V_{IN} - V_{OUT}) \leq 15\text{V}$		3.5	10	mA
Ripple Rejection		$f = 120\text{Hz}$, $C_{OUT} = 1\mu\text{F}$ Tantalum, $(V_{IN} - V_{OUT}) = 3\text{V}$, $I_{OUT} = 1\text{A}$	60	75		dB
Temperature Stability				1		%
Long -Term Stability		$T_A = 125^\circ\text{C}$, 1000hrs		0.3		%
RMS Output Noise (% of V_{OUT})		$T_A = 25^\circ\text{C}$, $10\text{Hz} \leq f \leq 10\text{kHz}$		0.003		%
Thermal Resistance, Junction to Case		SOT-223 TO-252 TO-220 TO-263		15 10 4.5 4		$^\circ\text{C}/\text{W}$
Thermal Shutdown		Junction Temperature		150		$^\circ\text{C}$
Thermal Shutdown Hysteresis				25		$^\circ\text{C}$

Note 2: Maximum Power Dissipation is Package Type and Case Temperature dependent. Please see Figure 12.



3-TERMINAL 1A ADJUSTABLE VOLTAGE REGULATOR

AZ317

Typical Performance Characteristics

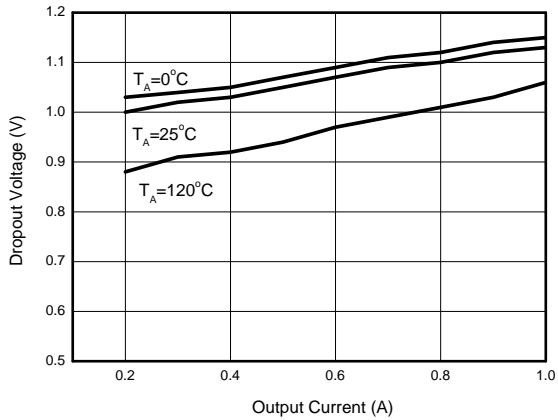

Figure 5. Dropout Voltage vs. Output Current

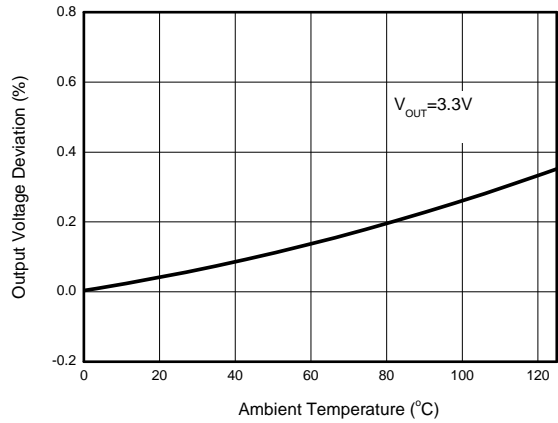

Figure 6. Load Regulation vs. Temperature

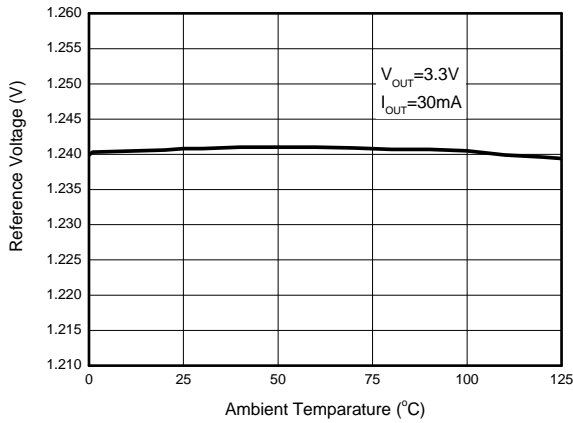

Figure 7. Reference Voltage vs. Temperature

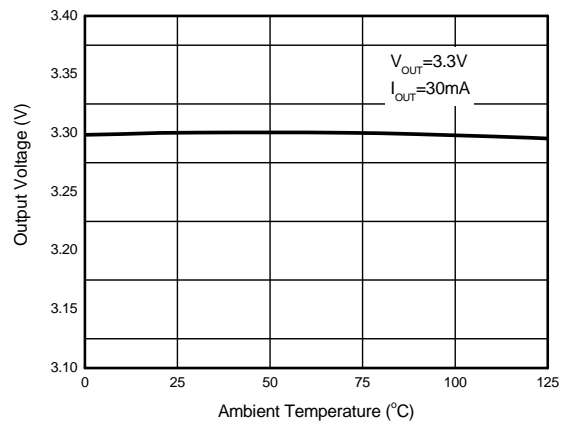

Figure 8. Output Voltage vs. Temperature



3-TERMINAL 1A ADJUSTABLE VOLTAGE REGULATOR

AZ317

Typical Performance Characteristics (Continued)

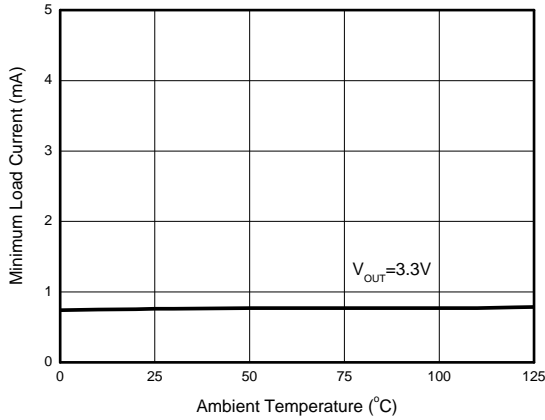

Figure 9. Minimum Load Current vs. Temperature

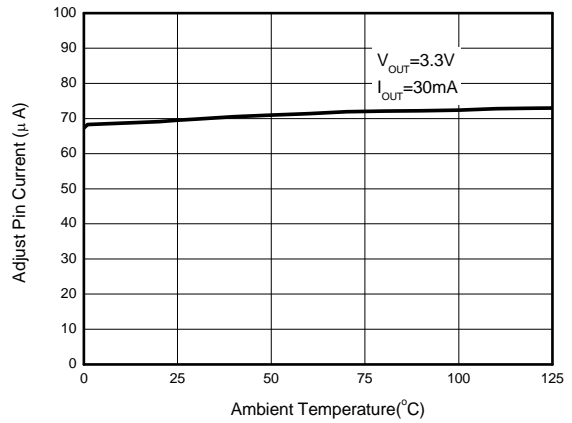

Figure 10. Adjust Pin Current vs. Temperature

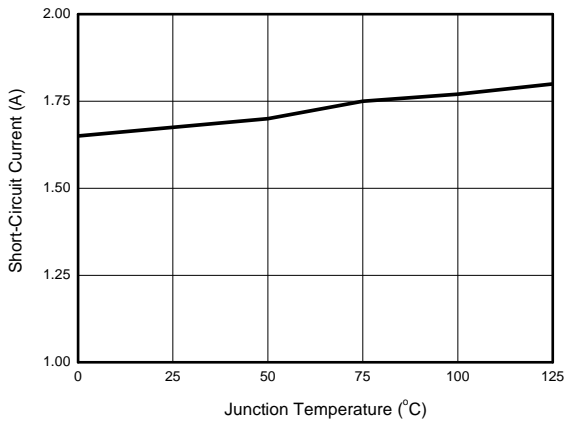

Figure 11. Short-Circuit Current vs. Temperature

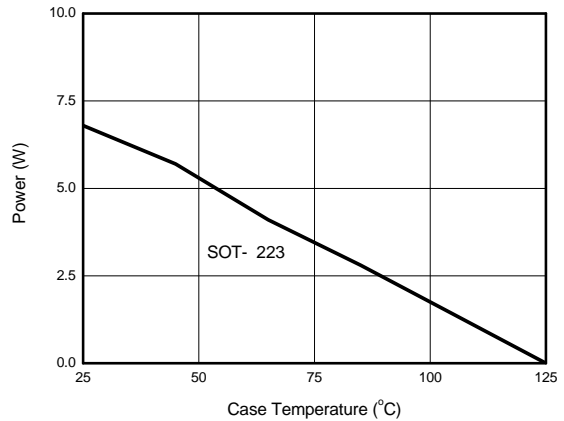

Figure 12. Maximum Power Dissipation



3-TERMINAL 1A ADJUSTABLE VOLTAGE REGULATOR

AZ317

Typical Performance Characteristics (Continued)

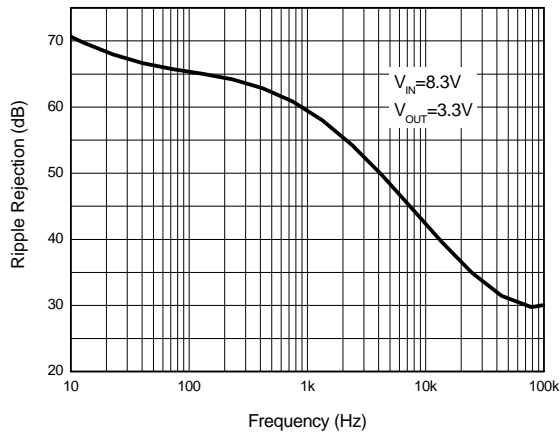

Figure 13. Ripple Rejection vs. Frequency

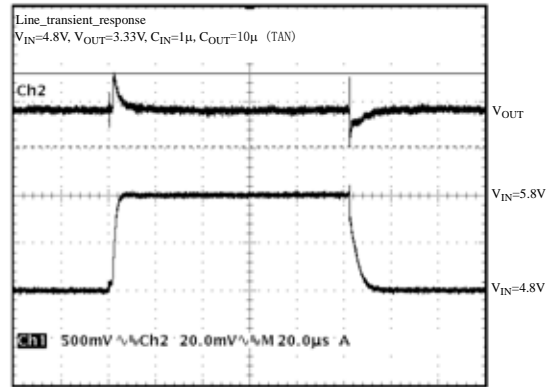

Figure 14. Line Transient Response

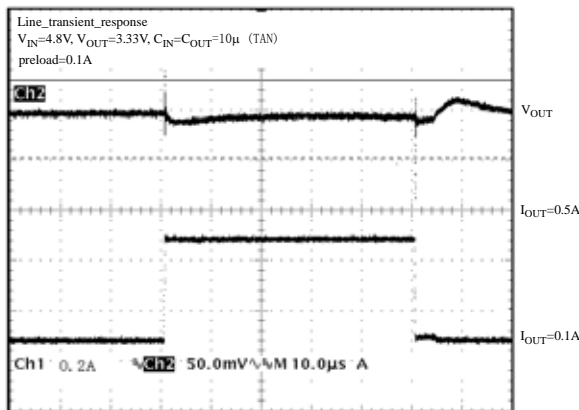
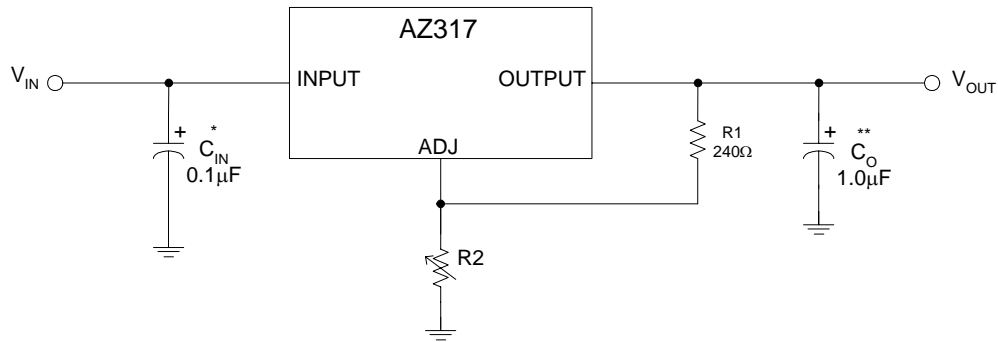

Figure 15. Load Transient Response

**3-TERMINAL 1A ADJUSTABLE VOLTAGE REGULATOR****AZ317****Typical Application**

* = C_{IN} is required if the regulator is located near power supply filter.

**= C_O is needed for stability and it improves transient response.

$$V_{OUT} = V_{REF} \times (1 + R2/R1) + I_{ADJ} \times R2$$

Since I_{ADJ} is controlled to less than $100\mu A$, the error associated with this term is negligible in most applications.

Figure 4. Typical Application of AZ317



3-TERMINAL 1A ADJUSTABLE VOLTAGE REGULATOR

AZ317

Mechanical Dimensions

SOT-223

Unit: mm(inch)

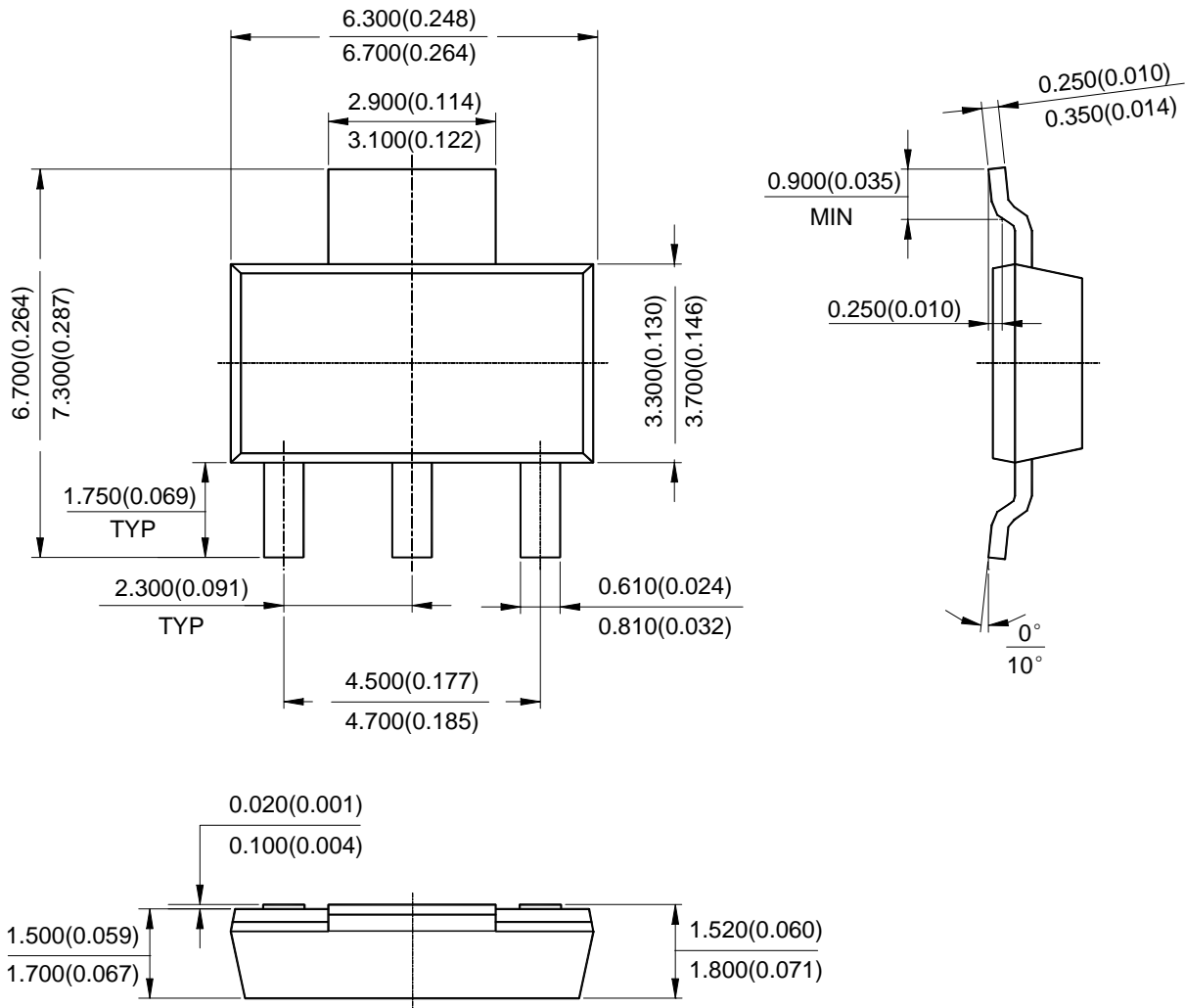



3-TERMINAL 1A ADJUSTABLE VOLTAGE REGULATOR

AZ317

Mechanical Dimensions (Continued)

TO-220-3

Unit: mm(inch)

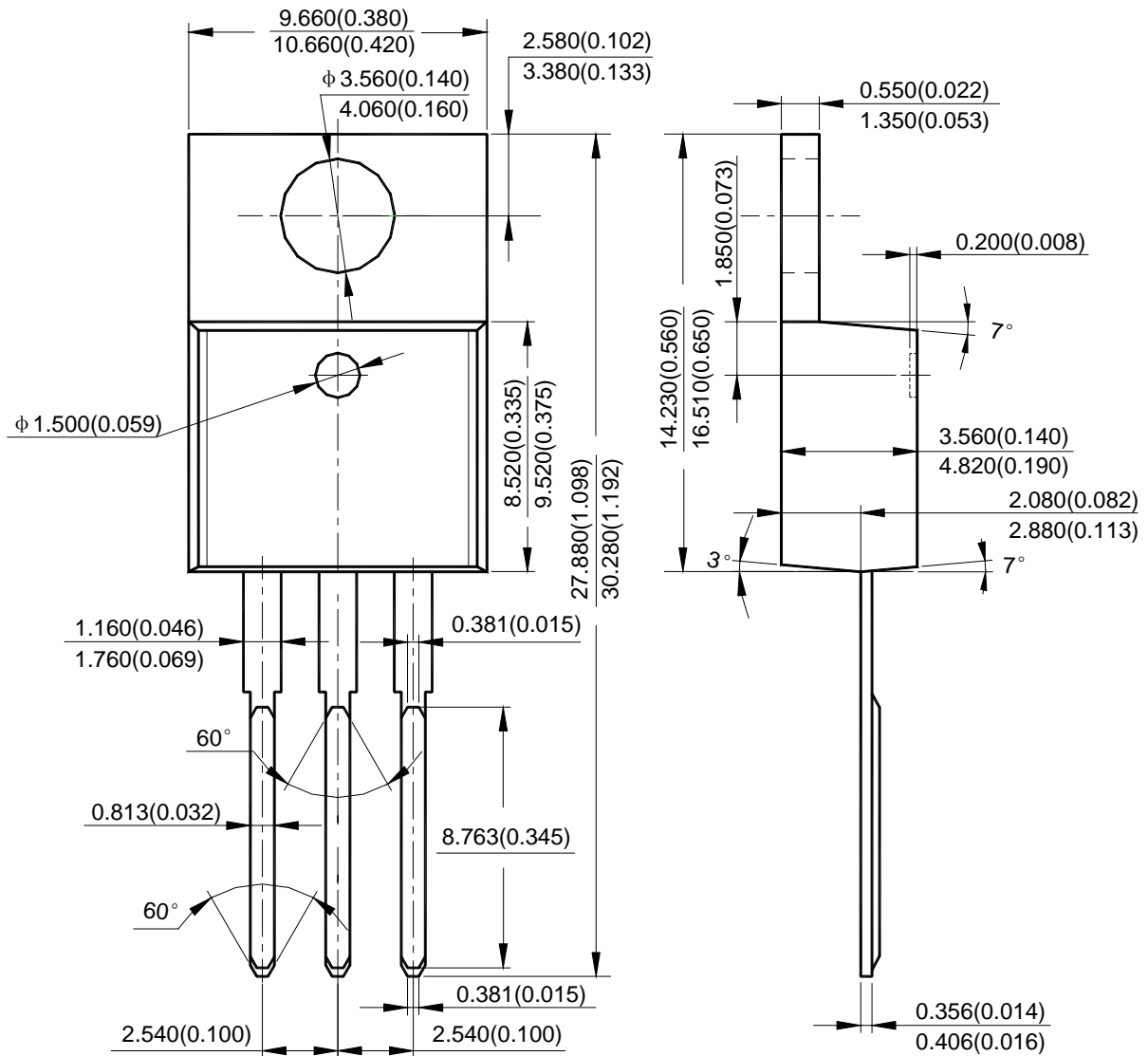



3-TERMINAL 1A ADJUSTABLE VOLTAGE REGULATOR

AZ317

Mechanical Dimensions (Continued)

TO-252-2(1)

Unit: mm(inch)

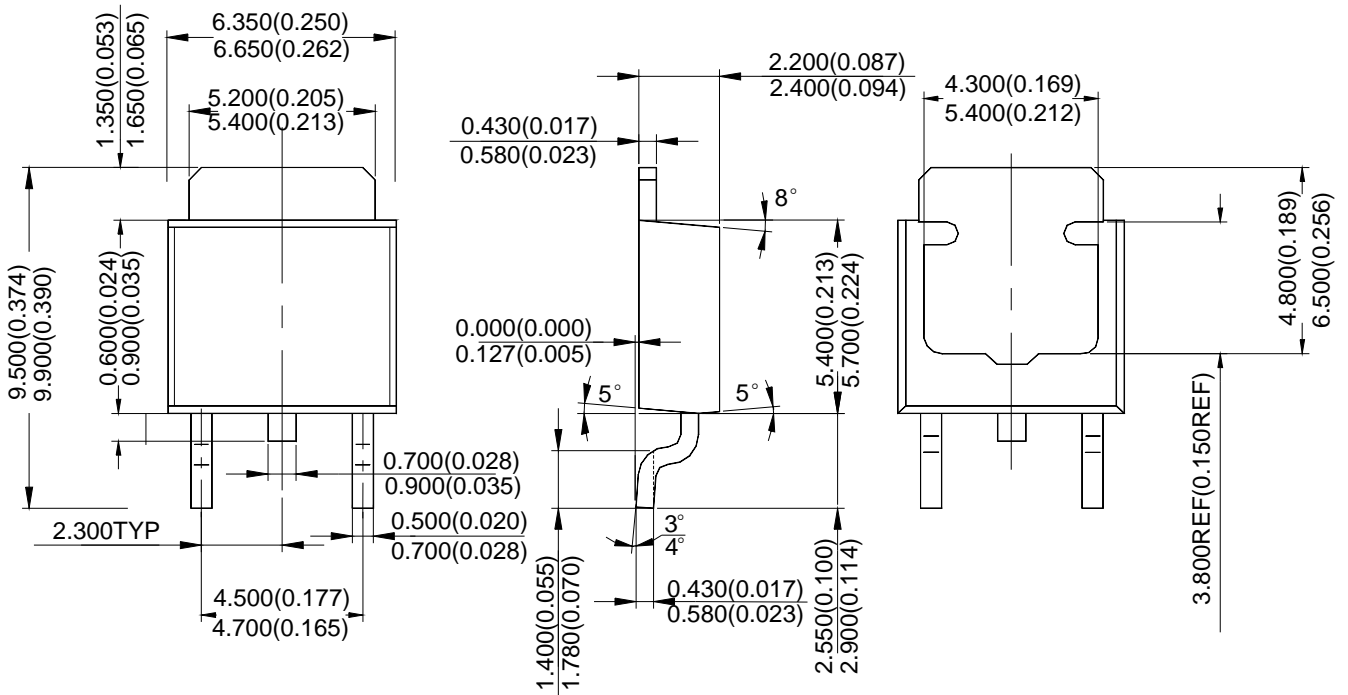



3-TERMINAL 1A ADJUSTABLE VOLTAGE REGULATOR

AZ317

Mechanical Dimensions (Continued)

TO-263-3

Unit: mm(inch)

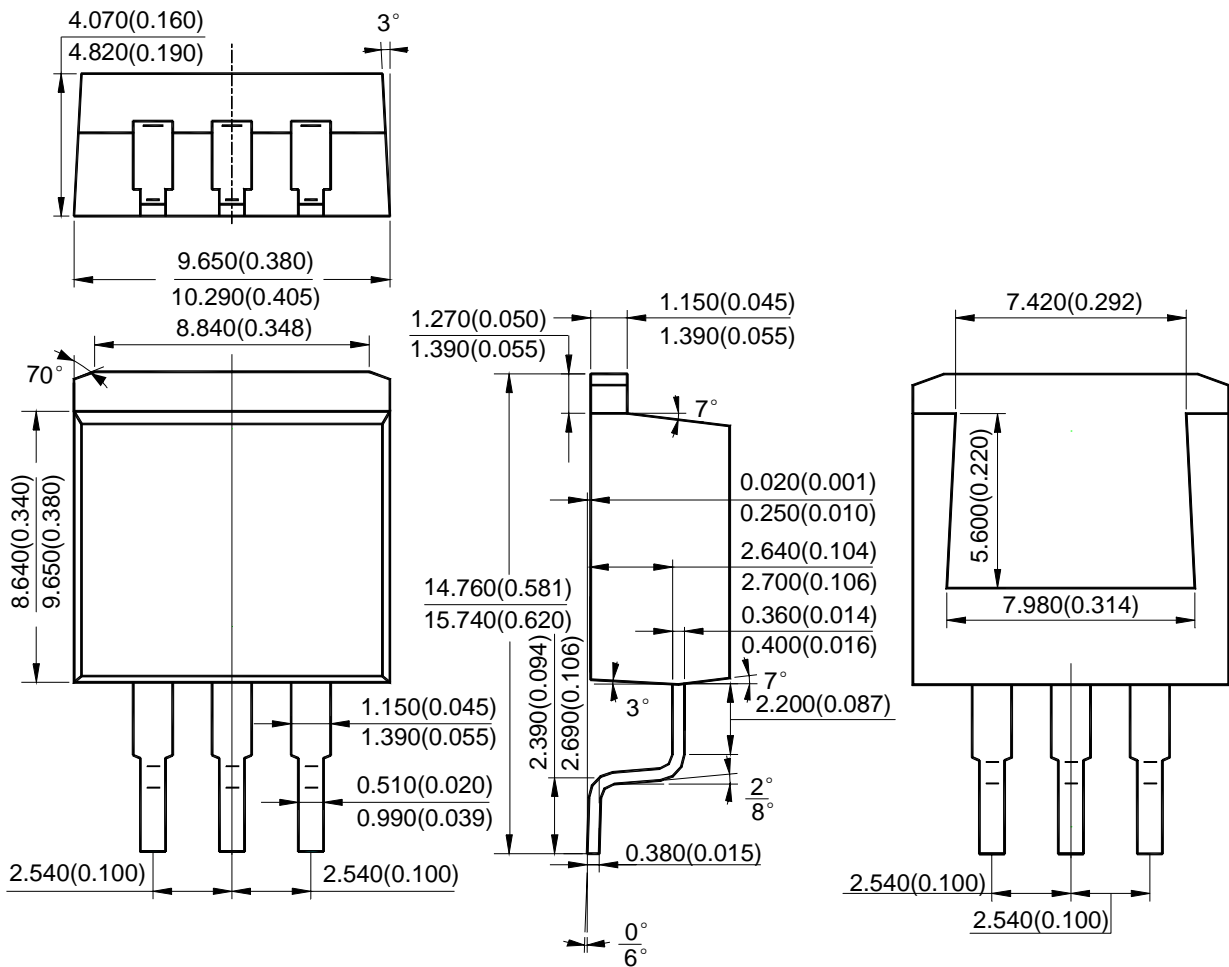



BCD Semiconductor Manufacturing Limited

<http://www.bcdsemi.com>

IMPORTANT NOTICE

BCD Semiconductor Manufacturing Limited reserves the right to make changes without further notice to any products or specifications herein. BCD Semiconductor Manufacturing Limited does not assume any responsibility for use of any its products for any particular purpose, nor does BCD Semiconductor Manufacturing Limited assume any liability arising out of the application or use of any its products or circuits. BCD Semiconductor Manufacturing Limited does not convey any license under its patent rights or other rights nor the rights of others.

MAIN SITE

BCD Semiconductor Manufacturing Limited
- Wafer Fab
Shanghai SIM-BCD Semiconductor Manufacturing Limited
800, Yi Shan Road, Shanghai 200233, China
Tel: +86-21-6485 1491, Fax: +86-21-5450 0008

BCD Semiconductor Manufacturing Limited
- IC Design Group
Advanced Analog Circuits (Shanghai) Corporation
8F, Zone B, 900, Yi Shan Road, Shanghai 200233, China
Tel: +86-21-6495 9539, Fax: +86-21-6485 9673

REGIONAL SALES OFFICE

Shenzhen Office
Shanghai SIM-BCD Semiconductor Manufacturing Co., Ltd. Shenzhen Office
Advanced Analog Circuits (Shanghai) Corporation Shenzhen Office
Room E, 5F, Noble Center, No.1006, 3rd Fuzhong Road, Futian District, Shenzhen 518026, China
Tel: +86-755-8826 7951
Fax: +86-755-8826 7865

Taiwan Office
BCD Semiconductor (Taiwan) Company Limited
4F, 298-1, Rui Guang Road, Nei-Hu District, Taipei,
Taiwan
Tel: +886-2-2656 2808
Fax: +886-2-2656 2806

USA Office
BCD Semiconductor Corporation
30920 Huntwood Ave. Hayward,
CA 94544, U.S.A
Tel : +1-510-324-2988
Fax: +1-510-324-2788