

FDZ7064AS

30V N-Channel PowerTrench® SyncFET™ BGA MOSFET

Features

- 13.5 A, 30 V. $R_{DS(ON)} = 5.6 \text{ m}\Omega @ V_{GS} = 10 \text{ V}$
 $R_{DS(ON)} = 7.1 \text{ m}\Omega @ V_{GS} = 4.5 \text{ V}$
- Occupies only 14 mm² of PCB area. Only 42% of the area of SO-8
- Ultra-thin package: less than 0.76 mm height when mounted to PCB
- 3.5 x 4 mm² Footprint
- High power and current handling capability.

Applications

- DC/DC converters

General Description

This MOSFET is designed to replace a single MOSFET and parallel Schottky diode in synchronous DC:DC power supplies. Combining Fairchild's 30V PowerTrench SyncFET process with state of the art BGA packaging, the FDZ7064AS minimizes both PCB space and $R_{DS(ON)}$. This BGA SyncFET embodies a breakthrough in both packaging and power MOSFET integration which enables the device to combine excellent thermal transfer characteristics, high current handling capability, ultra-low profile packaging, low gate charge, ultra-low reverse recovery charge and low $R_{DS(ON)}$.

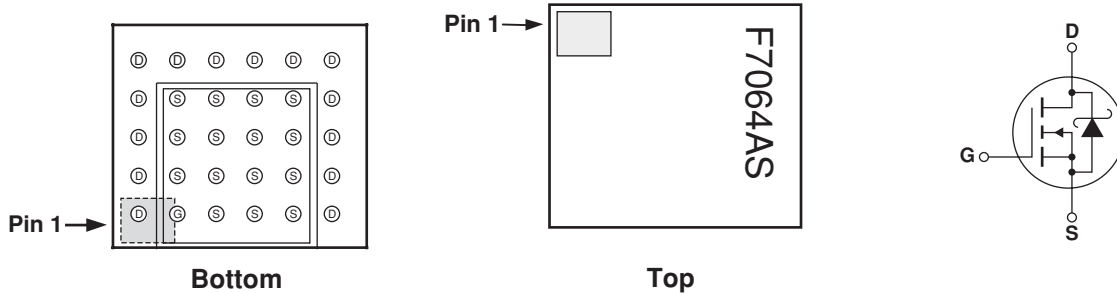

Absolute Maximum Ratings $T_A=25^\circ\text{C}$ unless otherwise noted

Symbol	Parameter	Ratings	Units
V_{DSS}	Drain-Source Voltage	30	V
V_{GSS}	Gate-Source Voltage	± 20	V
I_D	Drain Current	- Continuous (Note 1a)	13.5
		- Pulsed	60
P_D	Power Dissipation (Steady State) (Note 1a)	2.2	W
T_J, T_{stg}	Operating and Storage Junction Temperature Range	-55 to $+150$	$^\circ\text{C}$

Thermal Characteristics

$R_{\theta JA}$	Thermal Resistance, Junction-to-Ambient (Note 1a)	56	$^\circ\text{C/W}$
$R_{\theta JB}$	Thermal Resistance, Junction-to-Ball (Note 1)	4.5	
$R_{\theta JC}$	Thermal Resistance, Junction-to-Case (Note 1)	0.6	

Package Marking and Ordering Information

Device Marking	Device	Reel Size	Tape width	Quantity
7064AS	FDZ7064AS	13"	12mm	3000

Electrical Characteristics $T_A = 25^\circ\text{C}$ unless otherwise noted

Symbol	Parameter	Test Conditions	Min	Typ	Max	Units
Off Characteristics						
BV_{DSS}	Drain–Source Breakdown Voltage	$V_{GS} = 0\text{ V}, I_D = 1\text{ mA}$	30			V
$\frac{\Delta BV_{DSS}}{\Delta T_J}$	Breakdown Voltage Temperature Coefficient	$I_D = 10\text{ mA}$, Referenced to 25°C		25		mV/°C
I_{DSS}	Zero Gate Voltage Drain Current	$V_{DS} = 24\text{ V}, V_{GS} = 0\text{ V}$			500	µA
I_{GSS}	Gate–Body Leakage	$V_{GS} = \pm 20\text{ V}, V_{DS} = 0\text{ V}$			±100	nA
On Characteristics (Note 2)						
$V_{GS(th)}$	Gate Threshold Voltage	$V_{DS} = V_{GS}, I_D = 1\text{ mA}$	1	1.4	3	V
$\frac{\Delta V_{GS(th)}}{\Delta T_J}$	Gate Threshold Voltage Temperature Coefficient	$I_D = 10\text{ mA}$, Referenced to 25°C		–0.3		mV/°C
$R_{DS(on)}$	Static Drain–Source On–Resistance	$V_{GS} = 10\text{ V}, I_D = 13.5\text{ A}$ $V_{GS} = 4.5\text{ V}, I_D = 12\text{ A}$ $V_{GS} = 10\text{ V}, I_D = 13.5\text{ A}, T_J = 125^\circ\text{C}$		4.6 5.7 5.9	5.6 7.1 7.4	mΩ
$I_{D(on)}$	On–State Drain Current	$V_{GS} = 10\text{ V}, V_{DS} = 5\text{ V}$	60			A
g_{FS}	Forward Transconductance	$V_{DS} = 5\text{ V}, I_D = 13.5\text{ A}$		61		S
Dynamic Characteristics						
C_{iss}	Input Capacitance	$V_{DS} = 15\text{ V}, V_{GS} = 0\text{ V},$ $f = 1.0\text{ MHz}$		1960		pF
C_{oss}	Output Capacitance			570		pF
C_{rss}	Reverse Transfer Capacitance			210		pF
R_G	Gate Resistance	$V_{GS} = 15\text{ mV}, I_D = 6\text{ A}$		1.4		W
Switching Characteristics (Note 2)						
$t_{d(on)}$	Turn–On Delay Time	$V_{DS} = 15\text{ V}, I_D = 1\text{ A},$ $V_{GS} = 10\text{ V}, R_{GEN} = 6\ \Omega$		9	18	nS
t_r	Turn–On Rise Time			12	22	nS
$t_{d(off)}$	Turn–Off Delay Time			39	62	nS
t_f	Turn–Off Fall Time			18	33	nS
$Q_g(TOT)$	Total Gate Charge, $V_{gs} = 10\text{ V}$	$V_{DS} = 15\text{ V}, I_D = 13.5\text{ A}$		36	51	nC
Q_g	Total Gate Charge, $V_{gs} = 5\text{ V}$			20	28	nC
Q_{gs}	Gate–Source Charge			5		nC
Q_{gd}	Gate–Drain Charge			6		nC
Drain–Source Diode Characteristics						
V_{SD}	Drain–Source Diode Forward Voltage	$V_{GS} = 0\text{ V}, I_S = 3.2\text{ A}$ (Note 1)		0.4	0.7	V
t_{rr}	Diode Reverse Recovery Time	$I_F = 13.5\text{ A}, d_{IF}/d_t = 300\text{ A}/\mu\text{s}$		23		nS
Q_{rr}	Diode Reverse Recovery Charge	See Diode Characteristic, page 5		21		nC

Notes:

- $R_{\theta JA}$ is determined with the device mounted on a 1 in^2 2 oz. copper pad on a $1.5 \times 1.5\text{ in.}$ board of FR-4 material. The thermal resistance from the junction to the circuit board side of the solder ball, $R_{\theta JB}$, is defined for reference. For $R_{\theta JC}$, the thermal reference point for the case is defined as the top surface of the copper chip carrier. $R_{\theta JC}$ and $R_{\theta JB}$ are guaranteed by design while $R_{\theta JA}$ is determined by the user's board design.

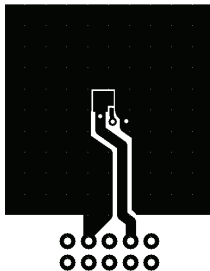

a) 56°C/W when mounted on a 1 in^2 pad of 2 oz copper

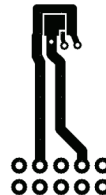

b) 119°C/W when mounted on a minimum pad of 2 oz copper

Scale 1 : 1 on letter size paper

- Pulse Test: Pulse Width < $300\ \mu\text{s}$, Duty Cycle < 2.0%

Typical Characteristics

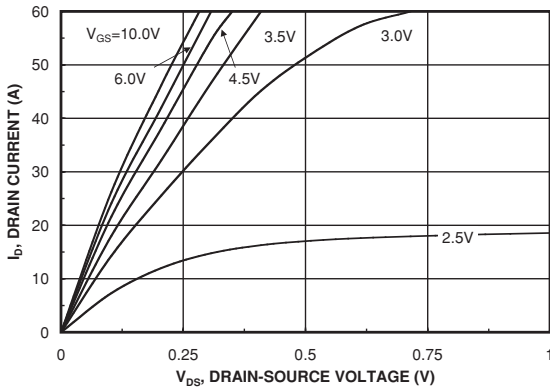

Figure 1. On-Region Characteristics.

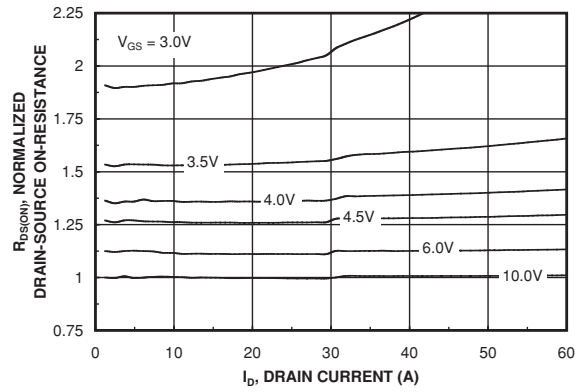

Figure 2. On-Resistance Variation with Drain Current and Gate Voltage.

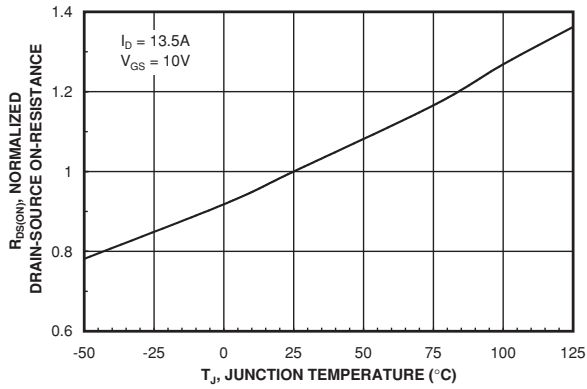

Figure 3. On-Resistance Variation with Temperature.

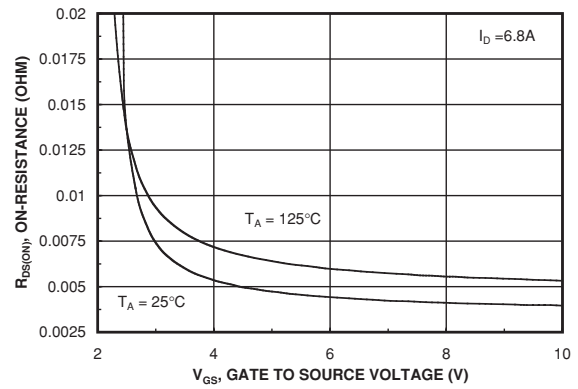

Figure 4. On-Resistance Variation with Gate-to-Source Voltage.

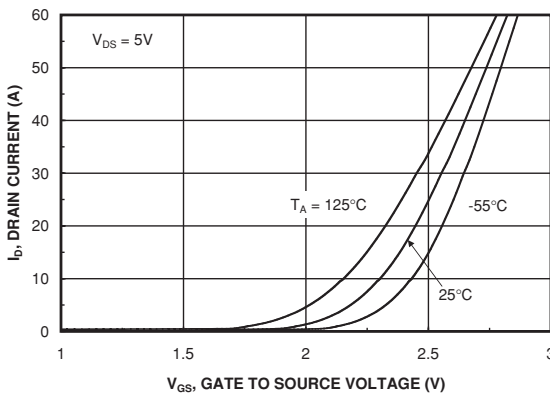

Figure 5. Transfer Characteristics.

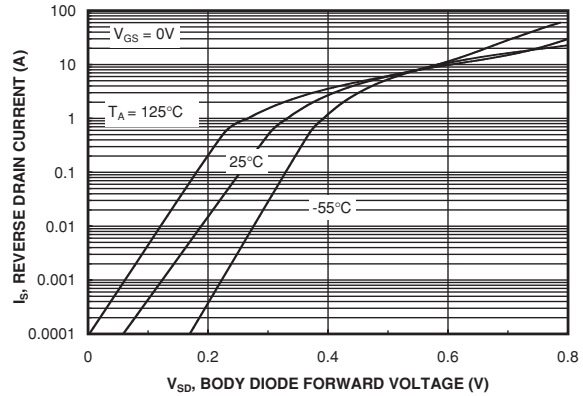

Figure 6. Body Diode Forward Voltage Variation with Source Current and Temperature.

Typical Characteristics

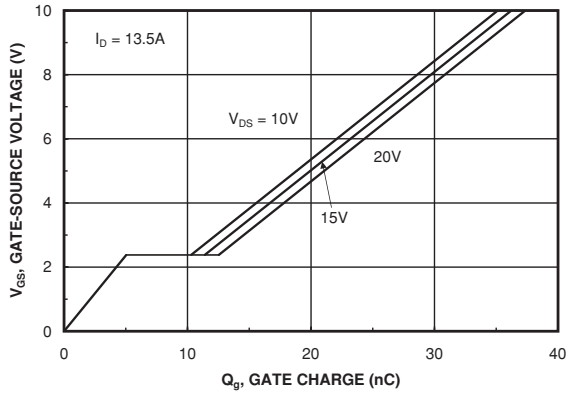

Figure 7. Gate Charge Characteristics.

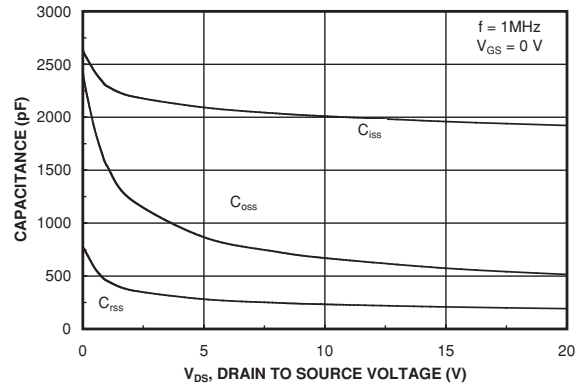

Figure 8. Capacitance Characteristics.

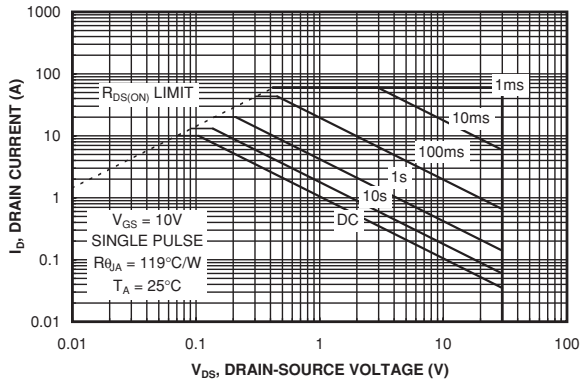

Figure 9. Maximum Safe Operating Area.

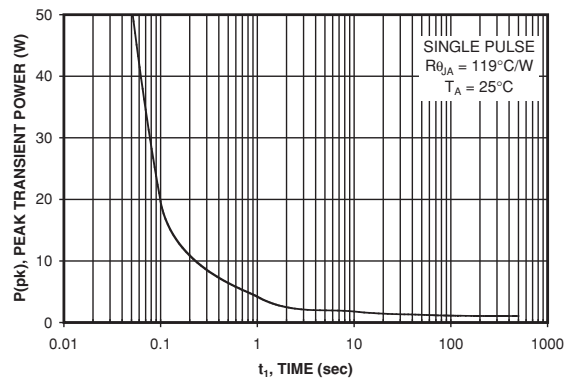

Figure 10. Single Pulse Maximum Power Dissipation.

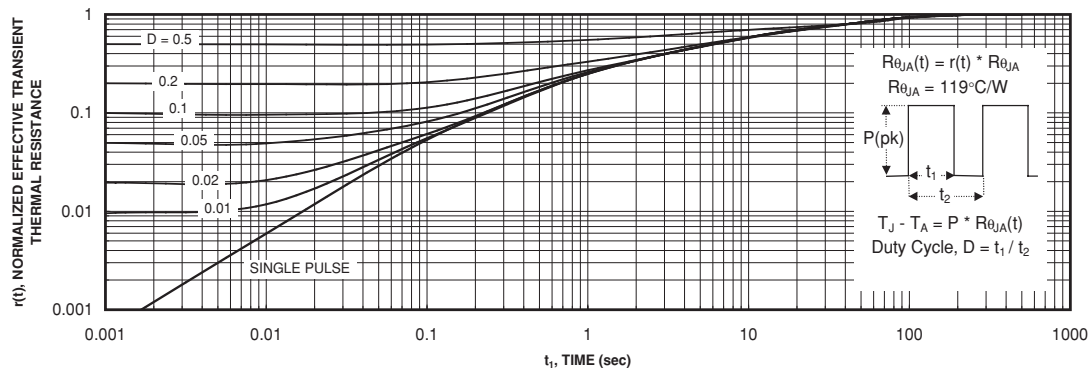

Figure 11. Transient Thermal Response Curve.

Thermal characterization performed using the conditions described in Note 1b. Transient thermal response will change depending on the circuit board design.

Typical Characteristics

SyncFET Diode Characteristics

Fairchild's SyncFET process embeds a Schottky diode in parallel with PowerTrench MOSFET. This diode exhibits similar characteristics to a discrete external Schottky diode in parallel with a MOSFET. Figure 12 FDZ7064AS.

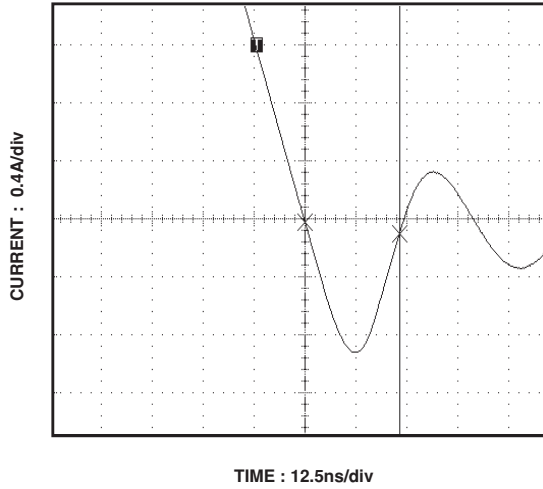

Figure 12. FDZ7064AS SyncFET body diode reverse recovery characteristic.

For comparison purposes, Figure 13 shows the reverse recovery characteristics of the body diode of an equivalent size MOSFET produced without SyncFET.

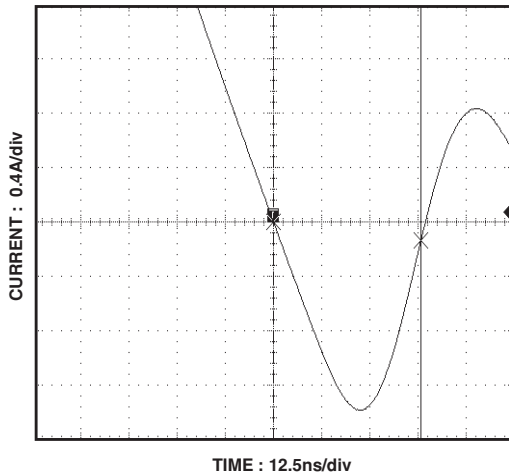

Figure 13. Non-SyncFET (FDZ7064N) body diode reverse recovery characteristic.

Schottky barrier diodes exhibit significant leakage at high temperature and high reverse voltage. This will increase the power in the device.

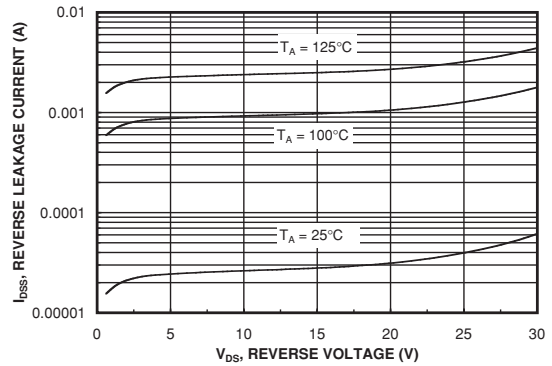
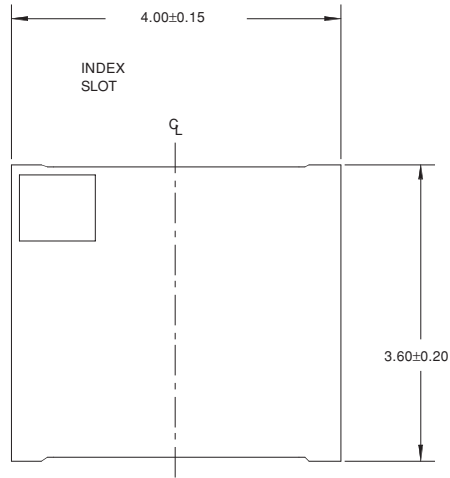
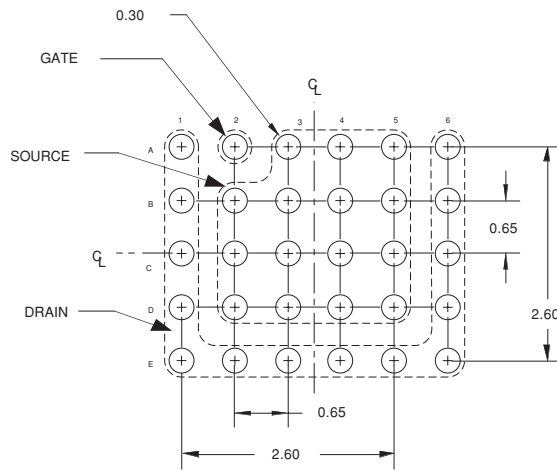

Figure 14. SyncFET diode reverse leakage versus drain-source voltage and temperature.

Dimensional Outline and Pad Layout



TOP VIEW



LAND PATTERN RECOMMENDATION

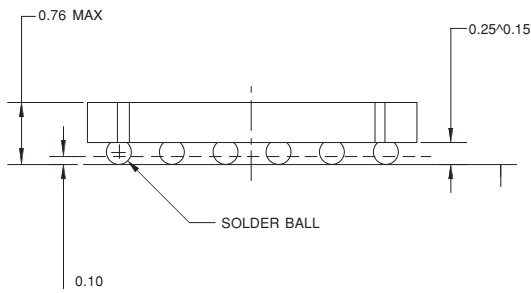

FRONT VIEW

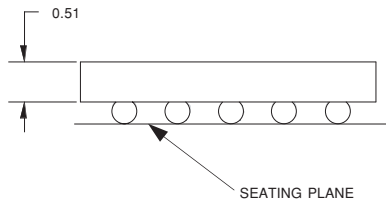

SIDE VIEW

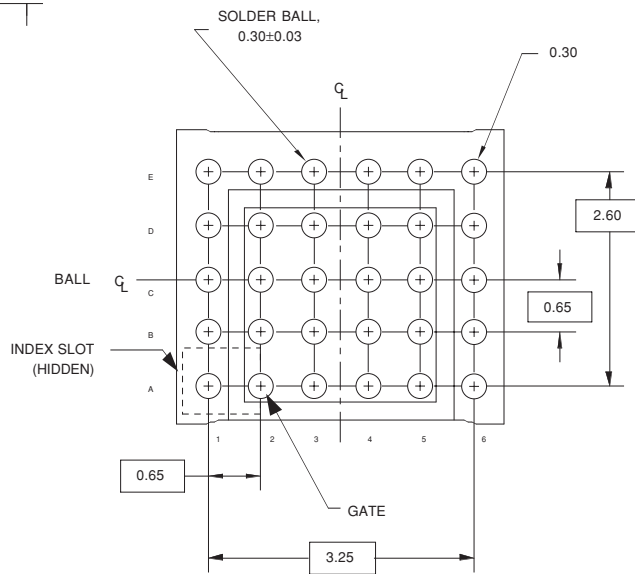

BOTTOM VIEW

NOTES: UNLESS OTHERWISE SPECIFIED

- A) ALL DIMENSIONS ARE IN MILLIMETERS.
- B) NO JEDEC REGISTRATION REFERENCE AS OF JULY 1999.

TRADEMARKS

The following are registered and unregistered trademarks Fairchild Semiconductor owns or is authorized to use and is not intended to be an exhaustive list of all such trademarks.

ACEx™	FAST®	ISOPLANAR™	Power247™	Stealth™
ActiveArray™	FASTr™	LittleFET™	PowerEdge™	SuperFET™
Bottomless™	FPS™	MICROCOUPLER™	PowerSaver™	SuperSOT™-3
CoolFET™	FRFET™	MicroFET™	PowerTrench®	SuperSOT™-6
CROSSVOLT™	GlobalOptoisolator™	MicroPak™	QFET®	SuperSOT™-8
DOMET™	GTO™	MICROWIRE™	QS™	SyncFET™
EcoSPARK™	HiSeC™	MSX™	QT Optoelectronics™	TinyLogic®
E ² C MOS™	PC™	MSXPro™	Quiet Series™	TINYOPTO™
EnSigna™	i-Lo™	OCX™	RapidConfigure™	TruTranslation™
FACT™	ImpliedDisconnect™	OCXPro™	RapidConnect™	UHC™
FACT Quiet Series™		OPTOLOGIC®	μSerDes™	UltraFET®
Across the board. Around the world.™		OPTOPLANAR™	SILENT SWITCHER®	UniFET™
The Power Franchise®		PACMAN™	SMART START™	VCX™
Programmable Active Droop™		POP™	SPM™	

DISCLAIMER

FAIRCHILD SEMICONDUCTOR RESERVES THE RIGHT TO MAKE CHANGES WITHOUT FURTHER NOTICE TO ANY PRODUCTS HEREIN TO IMPROVE RELIABILITY, FUNCTION OR DESIGN. FAIRCHILD DOES NOT ASSUME ANY LIABILITY ARISING OUT OF THE APPLICATION OR USE OF ANY PRODUCT OR CIRCUIT DESCRIBED HEREIN; NEITHER DOES IT CONVEY ANY LICENSE UNDER ITS PATENT RIGHTS, NOR THE RIGHTS OF OTHERS.

LIFE SUPPORT POLICY

FAIRCHILD'S PRODUCTS ARE NOT AUTHORIZED FOR USE AS CRITICAL COMPONENTS IN LIFE SUPPORT DEVICES OR SYSTEMS WITHOUT THE EXPRESS WRITTEN APPROVAL OF FAIRCHILD SEMICONDUCTOR CORPORATION. As used herein:

1. Life support devices or systems are devices or systems which, (a) are intended for surgical implant into the body, or (b) support or sustain life, or (c) whose failure to perform when properly used in accordance with instructions for use provided in the labeling, can be reasonably expected to result in significant injury to the user.
2. A critical component is any component of a life support device or system whose failure to perform can be reasonably expected to cause the failure of the life support device or system, or to affect its safety or effectiveness.

PRODUCT STATUS DEFINITIONS

Definition of Terms

Datasheet Identification	Product Status	Definition
Advance Information	Formative or In Design	This datasheet contains the design specifications for product development. Specifications may change in any manner without notice.
Preliminary	First Production	This datasheet contains preliminary data, and supplementary data will be published at a later date. Fairchild Semiconductor reserves the right to make changes at any time without notice in order to improve design.
No Identification Needed	Full Production	This datasheet contains final specifications. Fairchild Semiconductor reserves the right to make changes at any time without notice in order to improve design.
Obsolete	Not In Production	This datasheet contains specifications on a product that has been discontinued by Fairchild semiconductor. The datasheet is printed for reference information only.

Rev. I14