

FLC257MH-8

C-Band Power GaAs FET

FEATURES

- High Output Power: $P_{1dB} = 34.0\text{dBm(Typ.)}$
- High Gain: $G_{1dB} = 8.0\text{dB(Typ.)}$
- High PAE: $\eta_{add} = 35\%(Typ.)$
- Proven Reliability
- Hermetic Metal/Ceramic Package

DESCRIPTION

The FLC257MH-8 is a power GaAs FET that is designed for general purpose applications in the C-Band frequency range as it provides superior power, gain, and efficiency.

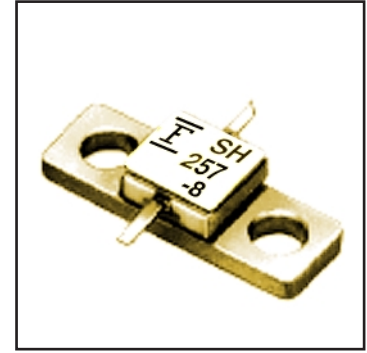

Fujitsu's stringent Quality Assurance Program assures the highest reliability and consistent performance.

ABSOLUTE MAXIMUM RATING (Ambient Temperature $T_a=25^\circ\text{C}$)

Item	Symbol	Condition	Rating	Unit
Drain-Source Voltage	V_{DS}		15	V
Gate-Source Voltage	V_{GS}		-5	V
Total Power Dissipation	P_T	$T_C = 25^\circ\text{C}$	15	W
Storage Temperature	T_{stg}		-65 to +175	$^\circ\text{C}$
Channel Temperature	T_{ch}		175	$^\circ\text{C}$

Fujitsu recommends the following conditions for the reliable operation of GaAs FETs:

1. The drain-source operating voltage (V_{DS}) should not exceed 10 volts.
2. The forward and reverse gate currents should not exceed 17.8 and -1.2 mA respectively with gate resistance of 200Ω .
3. The operating channel temperature (T_{ch}) should not exceed 145°C .

ELECTRICAL CHARACTERISTICS (Ambient Temperature $T_a=25^\circ\text{C}$)

Item	Symbol	Test Conditions	Limit			Unit
			Min.	Typ.	Max.	
Saturated Drain Current	I_{DSS}	$V_{DS} = 5\text{V}, V_{GS} = 0\text{V}$	-	1000	1500	mA
Transconductance	g_m	$V_{DS} = 5\text{V}, I_{DS} = 600\text{mA}$	-	500	-	mS
Pinch-off Voltage	V_p	$V_{DS} = 5\text{V}, I_{DS} = 50\text{mA}$	-1.0	-2.0	-3.5	V
Gate Source Breakdown Voltage	V_{GSO}	$I_{GS} = -50\mu\text{A}$	-5	-	-	V
Output Power at 1dB G.C.P.	P_{1dB}	$V_{DS} = 10\text{V},$ $I_{DS} = 0.6 I_{DSS} \text{ (Typ.)},$ $f = 8.5 \text{ GHz}$	32.5	34.0	-	dBm
Power Gain at 1dB G.C.P.	G_{1dB}		7.0	8.0	-	dB
Power-added Efficiency	η_{add}		-	35	-	%
Thermal Resistance	R_{th}	Channel to Case	-	8	10	$^\circ\text{C/W}$

CASE STYLE: MH

G.C.P.: Gain Compression Point

FLC257MH-8

C-Band Power GaAs FET

POWER DERATING CURVE

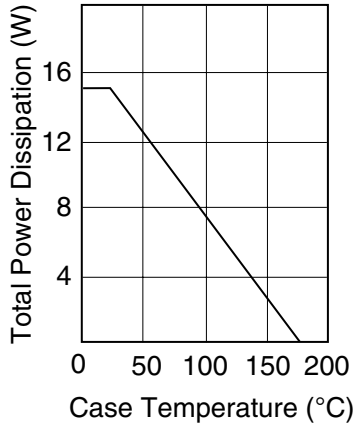

DRAIN CURRENT vs. DRAIN-SOURCE VOLTAGE

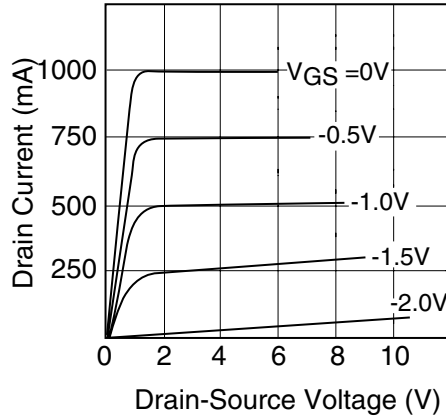

OUTPUT POWER & IM₃ vs. INPUT POWER

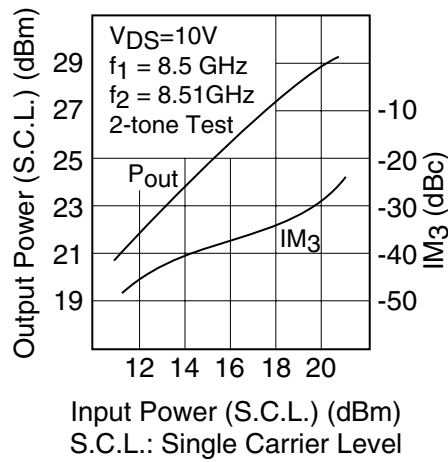

OUTPUT POWER vs. INPUT POWER

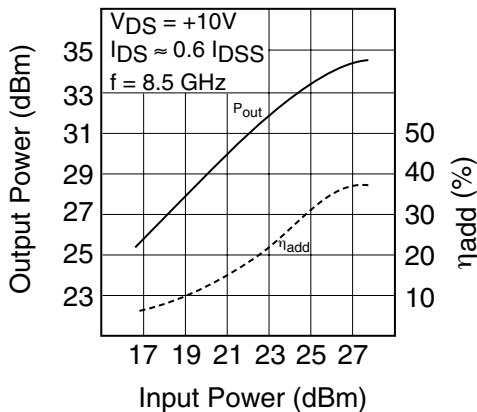

P_{1dB} & η_{add} vs. V_{DS}

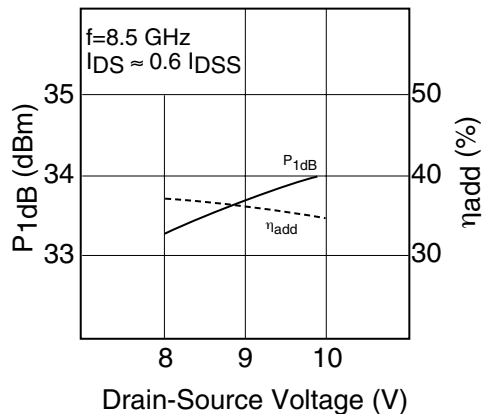

FLC257MH-8

C-Band Power GaAs FET

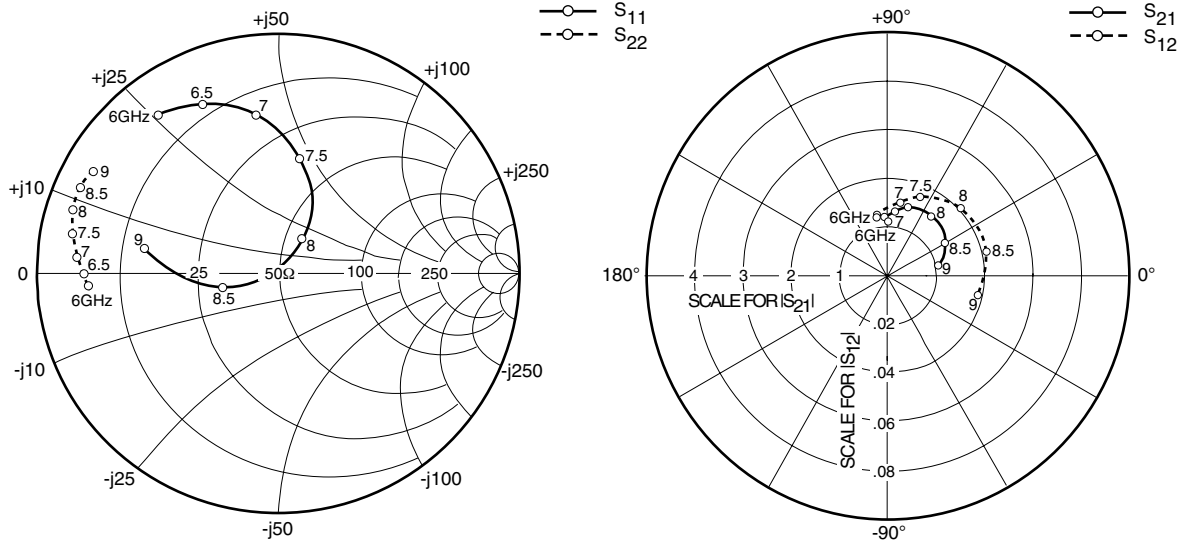

S-PARAMETERS

$V_{DS} = 10V, I_{DS} = 600mA$

FREQUENCY (MHZ)	S11		S21		S12		S22	
	MAG	ANG	MAG	ANG	MAG	ANG	MAG	ANG
500	.928	-142.8	7.163	109.2	.021	28.8	.344	-157.2
6000	.826	127.2	1.097	90.1	.025	99.3	.778	-174.5
6500	.770	114.2	1.179	92.6	.026	98.5	.798	-179.6
7000	.666	98.0	1.270	84.3	.030	81.0	.834	175.7
7500	.485	78.9	1.453	73.2	.035	67.7	.863	169.2
8000	.170	55.0	1.500	53.1	.041	43.3	.894	162.7
8500	.243	-164.9	1.368	29.9	.042	14.0	.889	156.1
9000	.561	170.0	1.053	10.3	.038	-12.0	.874	150.6
9500	.740	150.0	.758	-1.9	.029	-29.6	.848	146.0
10000	.828	134.3	.569	-9.3	.023	-40.1	.846	143.4

FLC257MH-8

C-Band Power GaAs FET

Case Style "MH" Metal-Ceramic Hermetic Package

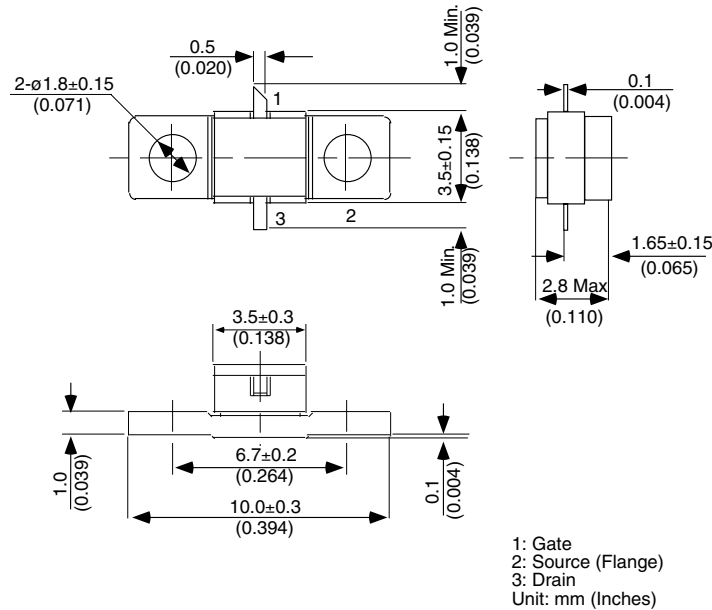

For further information please contact:

FUJITSU COMPOUND SEMICONDUCTOR, INC.

2355 Zanker Rd.

San Jose, CA 95131-1138, U.S.A.

Phone: (408) 232-9500

FAX: (408) 428-9111

www.fcsi.fujitsu.com

FUJITSU MICROELECTRONICS, LTD.

Compound Semiconductor Division

Network House

Norreys Drive

Maidenhead, Berkshire SL6 4FJ

Phone: +44 (0)1628 504800

FAX: +44 (0)1628 504888

CAUTION

Fujitsu Compound Semiconductor Products contain **gallium arsenide (GaAs)** which can be hazardous to the human body and the environment. For safety, observe the following procedures:

- Do not put these products into the mouth.
- Do not alter the form of this product into a gas, powder, or liquid through burning, crushing, or chemical processing as these by-products are dangerous to the human body if inhaled, ingested, or swallowed.
- Observe government laws and company regulations when discarding this product. This product must be discarded in accordance with methods specified by applicable hazardous waste procedures.

Fujitsu Limited reserves the right to change products and specifications without notice. The information does not convey any license under rights of Fujitsu Limited or others.

© 1998 FUJITSU COMPOUND SEMICONDUCTOR, INC.

Printed in U.S.A. FCSI0598M200

FUJITSU