

Termination of coaxial cables in automotive, medical and instrumentation applications utilizes a single motion to crimp the center conductor, shield and outer insulation.

GT13 Series

— Connectors for coaxial cables —

<Several types and configurations: In-line, board mounted, combinations of coaxial cable with signal/power. Multi-position.>

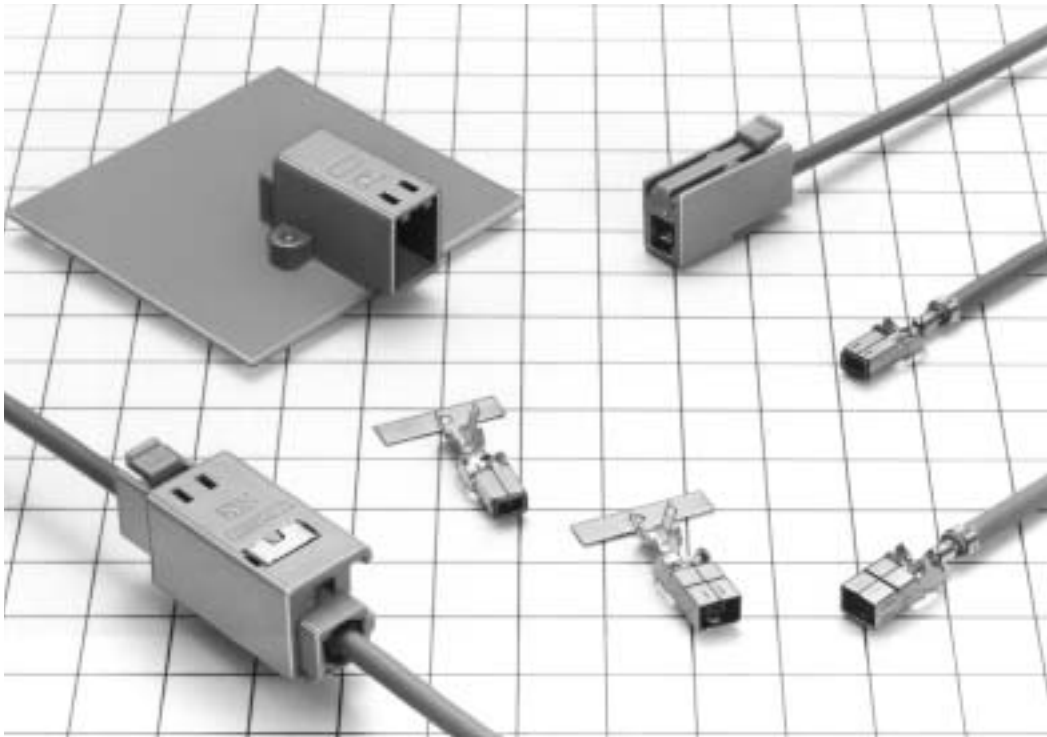

■ Features

- **Cost efficient termination**
Highly efficient and reliable single motion crimp termination allows high volume production with semi-automatic equipment.
- **Space-saving Design**
- **Lock-release latching system**
- **Shock / vibration resistant electrical connections**
- **Verification of the full contact insertion**

■ Applications

In-car communication, car sensors (temperature, pressure), automotive audio systems, GPS antenna systems, RACS antenna audio/video antenna systems, CRT displays, medical and measuring instrumentation, variety of communication equipment, office automation equipment, LAN systems.

F Terminals

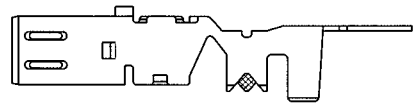
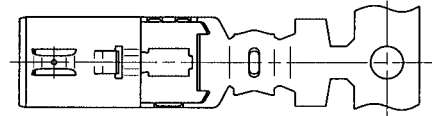
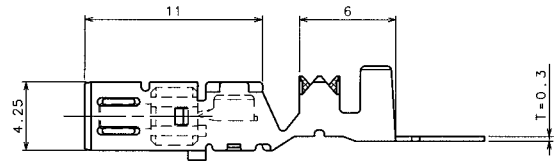
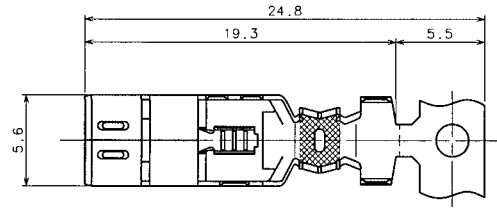
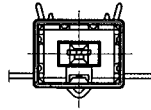

Part Number	CL No.	Conductor Size (AWG)	Inner Insulation Diameter	Outer Diameter	Packaging
GT13-2428/1.6-2.9SCF	763-0001-3	AWG #24 to 28 or equivalent	1.5 to 2.0	1.6 to 3.4	3,000 pieces per reel
GT13-30/1.6-2.9SCF	763-0012-0	AWG #30 or equivalent			

M Terminals

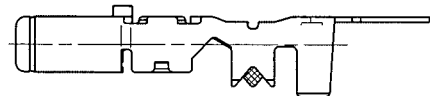
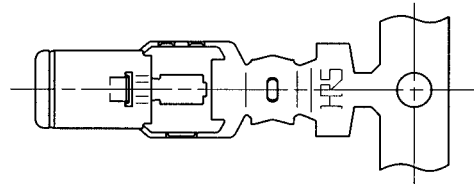
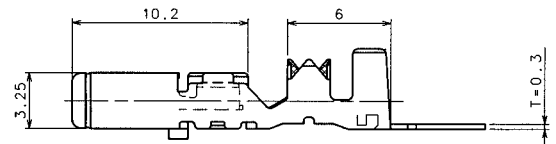
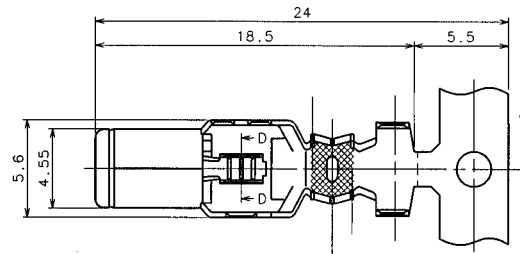
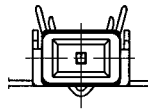

Part Number	CL No.	Conductor Size (AWG)	Inner Insulation Diameter	Outer Diameter	Packaging
GT13-2428/1.6-2.9PCF	763-0002-6	AWG #24 to 28 or equivalent	1.5 to 2.0	1.6 to 3.4	4,000 pieces per reel
GT13-30/1.6-2.9PCF	763-0041-8	AWG #30 or equivalent			

F Connector Power Supply Terminal

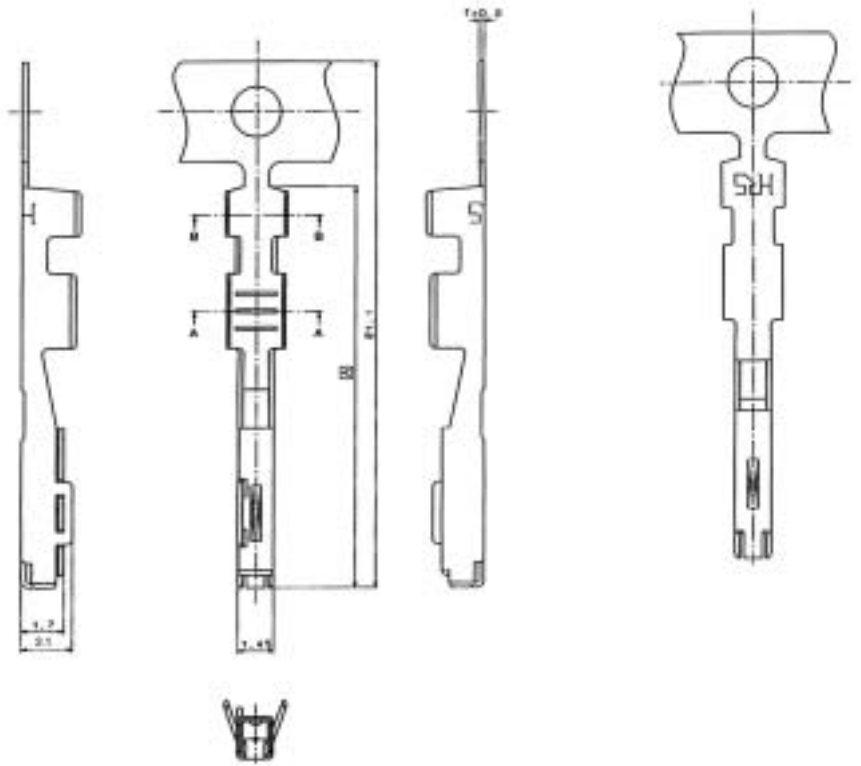

Part Number	CL No.	Packaging
GT10A-2022SCF	760-0014-6	8,000 pieces per reel

M Connector Power Supply Terminal

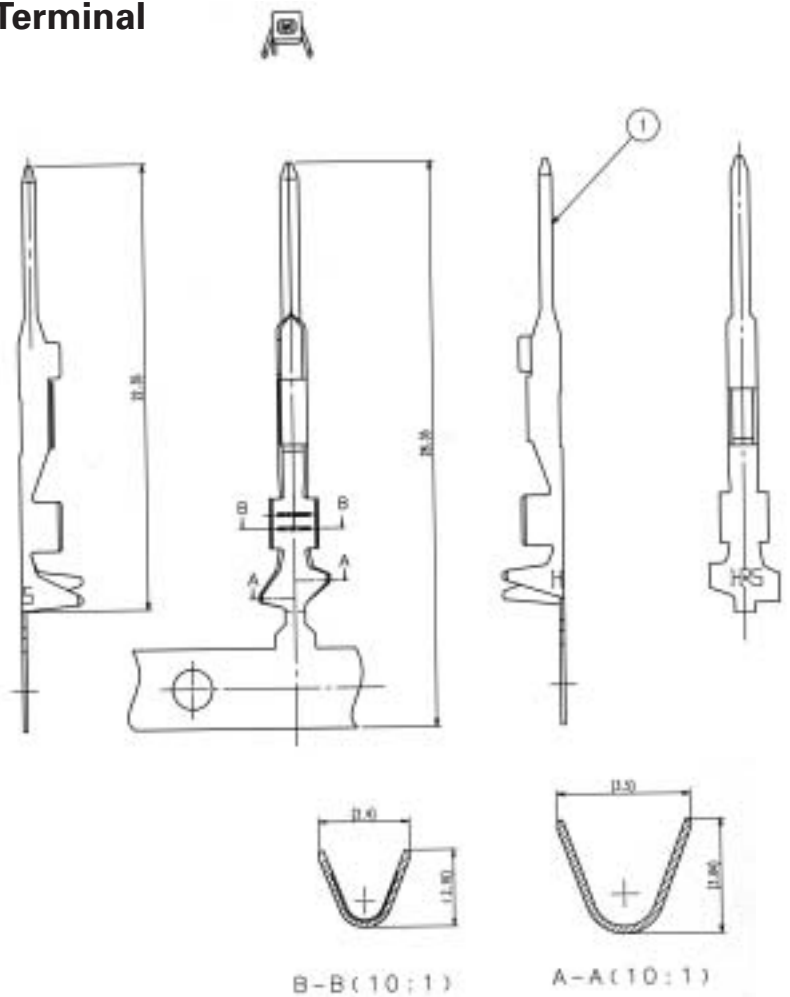

Part Number	CL No.	Packaging
GT10SC-2022PCF	760-0016-1	7,000 pieces per reel

F Housing



◆ Shown with inserted retainer.

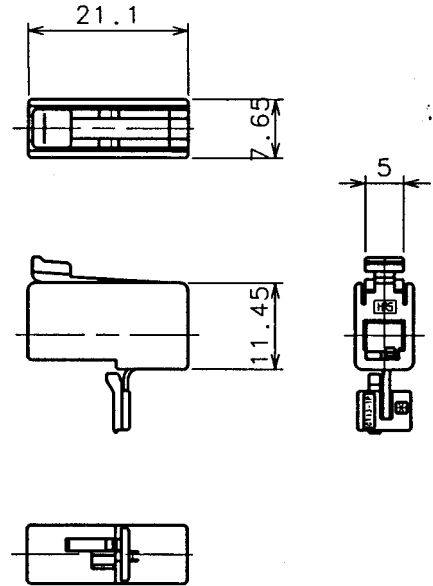

Part Number	CL No.
GT13-1S-HU	763-0003-9

M Housing



◆ Recommended Mounting Bracket Dimensions

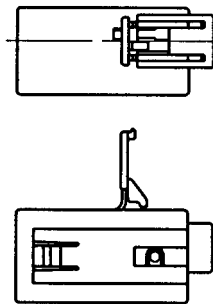
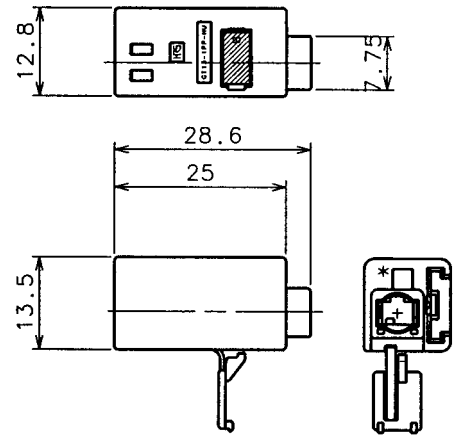
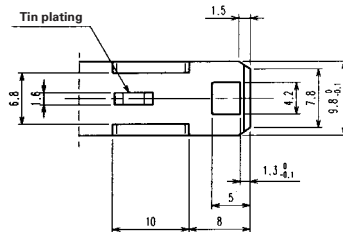

◆ Fully mated connector assemblies

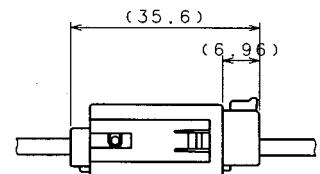
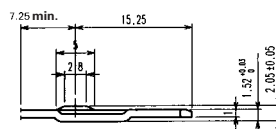

F Connectors

● One-position Type

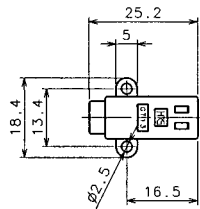

◆ Recommended Board Mounting Pattern

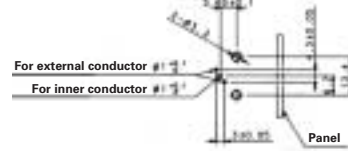

◆ Recommended Panel Dimensions Diagram

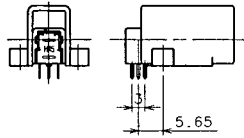
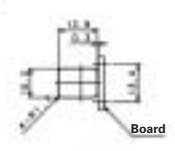

◆ Fully mated connector assemblies

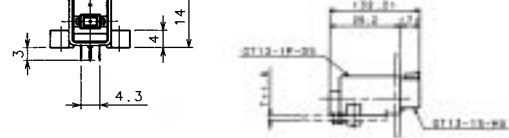

Part Number	CL No.
GT13-1P-DS	763-0005-4

● 3-position type

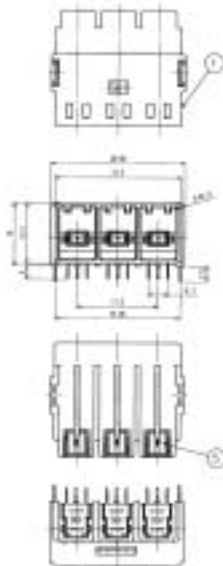

◆ Recommended Board Mounting Pattern

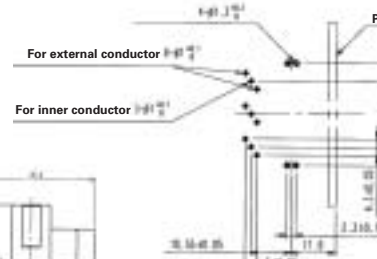

◆ Recommended Panel Dimensions Diagram

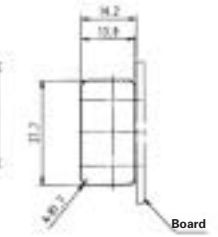

◆ Fully mated connector assemblies

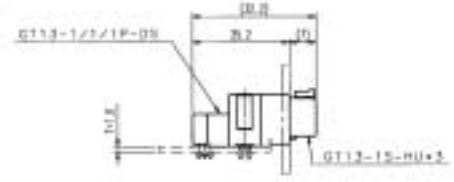

Part Number	CL No.
GT13-1/1/1P-DS	763-0007-0

● 4-position type

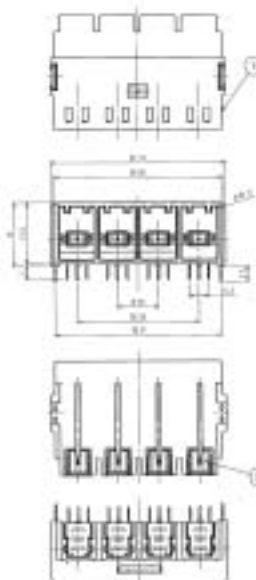

◆ Recommended Board Mounting Pattern

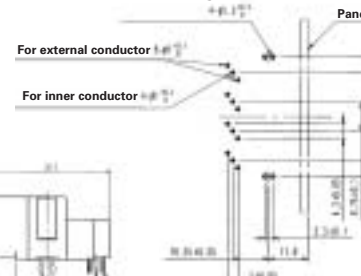

◆ Recommended Panel Dimensions Diagram

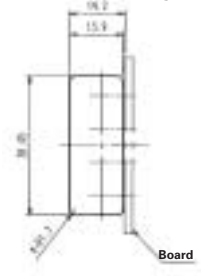

◆ Fully mated connector assemblies

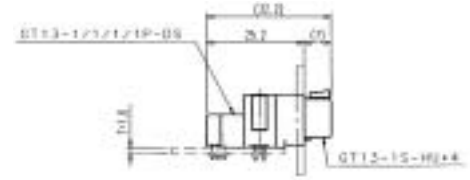

Part Number	CL No.
GT13-1/1/1/1P-DS	763-0008-2

13S Series

F Housing

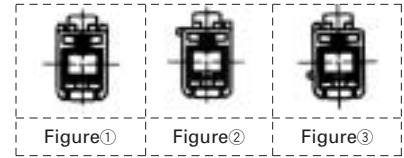
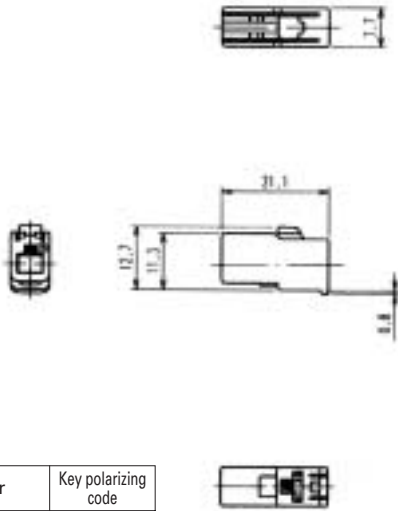

◆ Shown with inserted retainer.

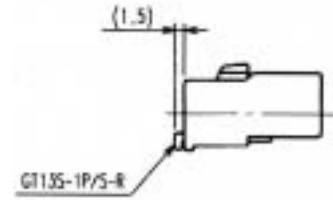

Part Number	CL No.	Material	Color	Key polarizing code
GT13S-1S-HU	763-0024-9	PBT	Light Gray	Figure①
GT13S-1S-HU (A)	763-0025-1	PBT	Brown	Figure②
GT13S-1S-HU (B)	763-0026-4	PBT	Green	Figure③

M Housing

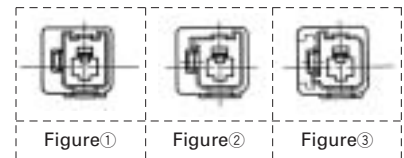
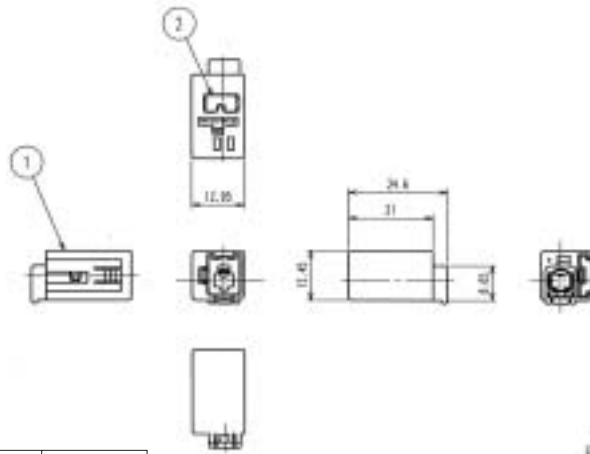

◆ Fully mated connector assemblies

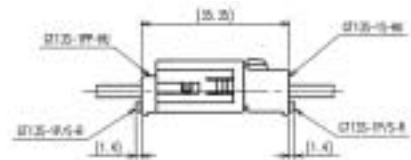

Part Number	CL No.	Color	Key polarizing code
GT13S-1PP-HU	763-0030-1	Light Gray	Figure①
GT13S-1PP-HU (A)	763-0031-4	Brown	Figure②
GT13S-1PP-HU (B)	763-0032-7	Green	Figure③

Part	Material	Finish
Ground terminal	Copper alloy	Tin plating
Housing	PBT	—

Retainer

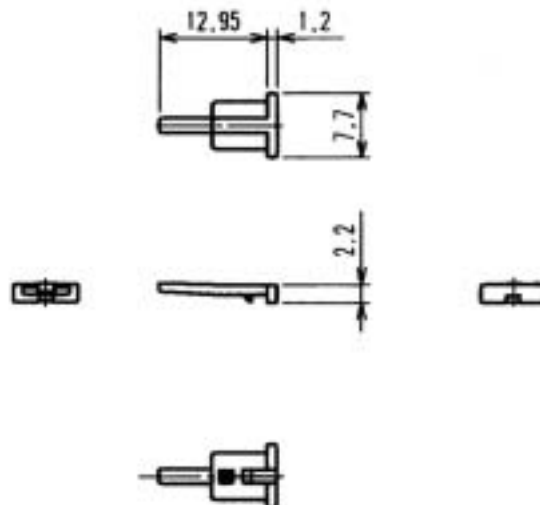

Part Number	CL No.
GT13S-1P/S-R	763-0033-0

GT13SC Series

F Housing

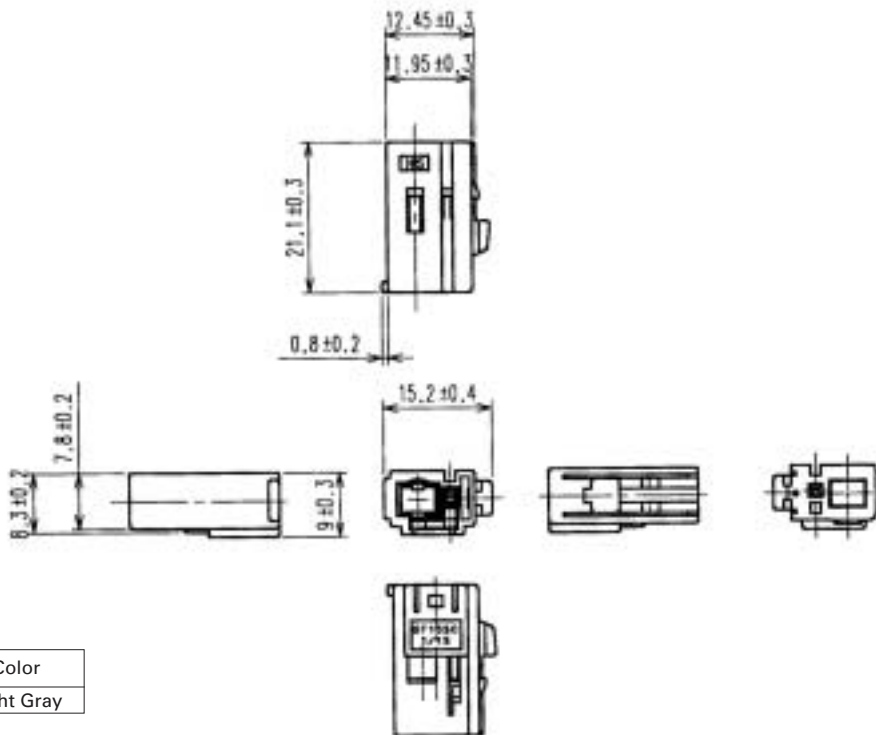

Part Number	CL No.	Material	Color
GT13SC-1/1S-HU	763-0010-4	PBT	Light Gray

* GT10A-2022SCF is used for power supply terminals.

● Retainer

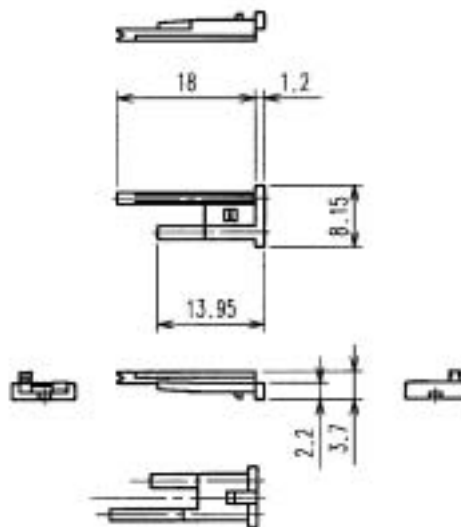
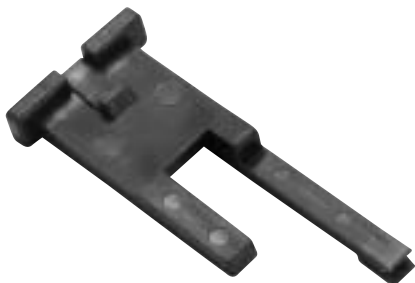

Part Number	CL No.	Material	Color
GT13SC-1/1S-R	763-0011-7	PBT	Dark Gray

F Housing (2 Position)

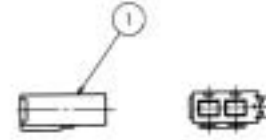
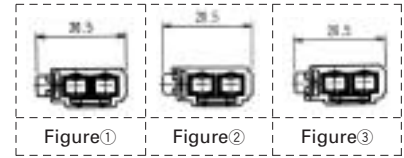
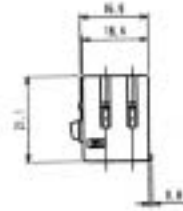

◆ Shown with inserted retainer.

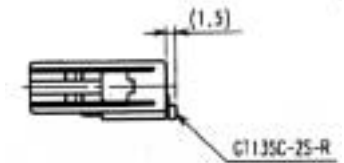

Part Number	CL No.	Color	Key polarizing code
GT13SC-2S-HU	763-0014-5	Light Gray	Figure①
GT13SC-2S-HU (A)	763-0043-3	Brown	Figure②
GT13SC-2S-HU (B)	763-0037-0	Green	Figure③

● Retainer (Used with GT13SC-2S-HU and GT13SCN-2PP-HU)

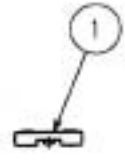
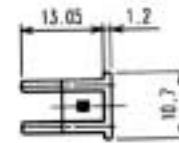

Part Number	CL No.	Material	Color
GT13SC-2S-R	763-0015-8	PBT	Dark Gray

F Housing (Two Single-Conductor Coaxial Cables + One Power contact)

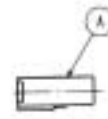
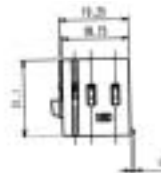

◆ Shown with inserted retainer.

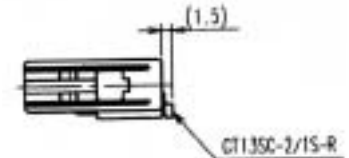

Part Number	CL No.	Material	Color
GT13SC-2/1S-HU	763-0016-0	PBT	Light Gray

* GT10A-2022SCF is used for power supply terminals.

● Retainer (Used with GT13SC-2/1S-HU)

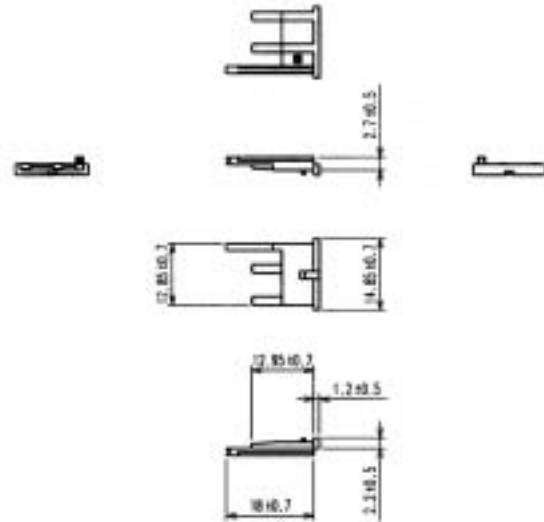

Part Number	CL No.	Material	Color
GT13SC-2/1S-R	763-0017-3	PBT	Dark Gray

■ F Housing (4 Single-Conductor Coaxial Cables + One Power contact)

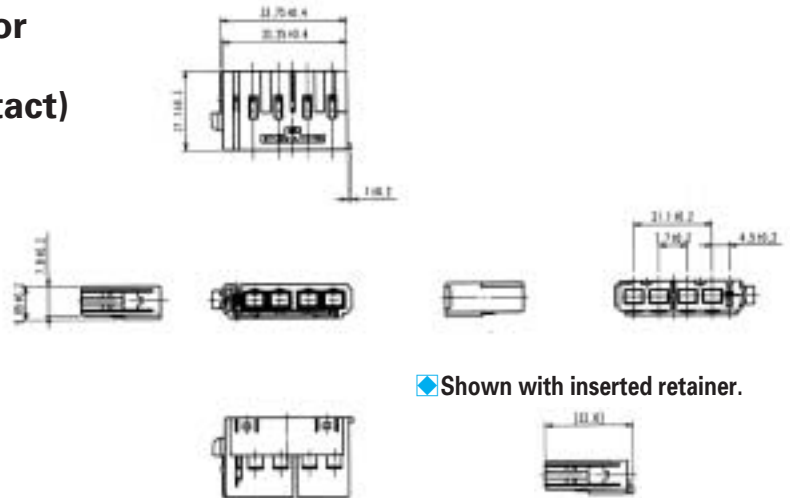

◆ Shown with inserted retainer.

Part Number	CL No.	Color
GT13SC-4/1S-HU	763-0021-0	Light Gray
GT13SC-4/1S-HU (A)	763-0022-3	Brown

* GT10A-2022SCF is used for power supply terminals.

● Retainer (Used with GT13SC-4/1S-R)

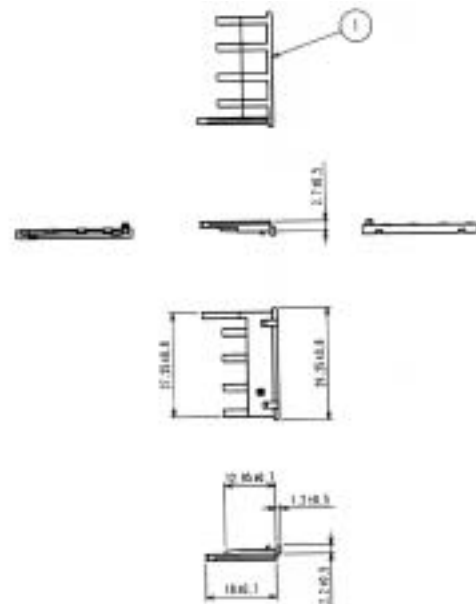

Part Number	CL No.
GT13SC-4/1S-R	763-0023-6

M Connectors

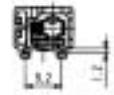
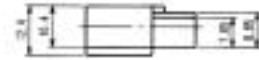
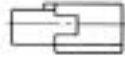
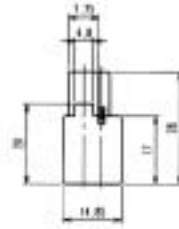

Fully mated connector assemblies

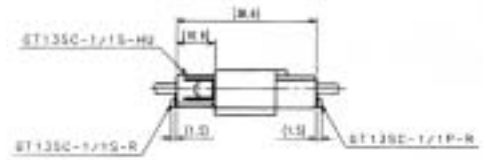

Part Number	CL No.	Material	Color
GT13SCN-1/1PP-HU	763-0036-8	PBT	Gray

* GT10SC-2022PCF is used for power supply terminals.

Retainer (Used with GT13SCN-1/1PP-HU)

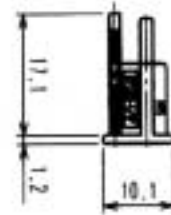
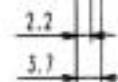

Part Number	CL No.	Material	Color
GT13SC-1/1P-R	763-0039-6	PBT	Dark Gray

Two position M Connectors

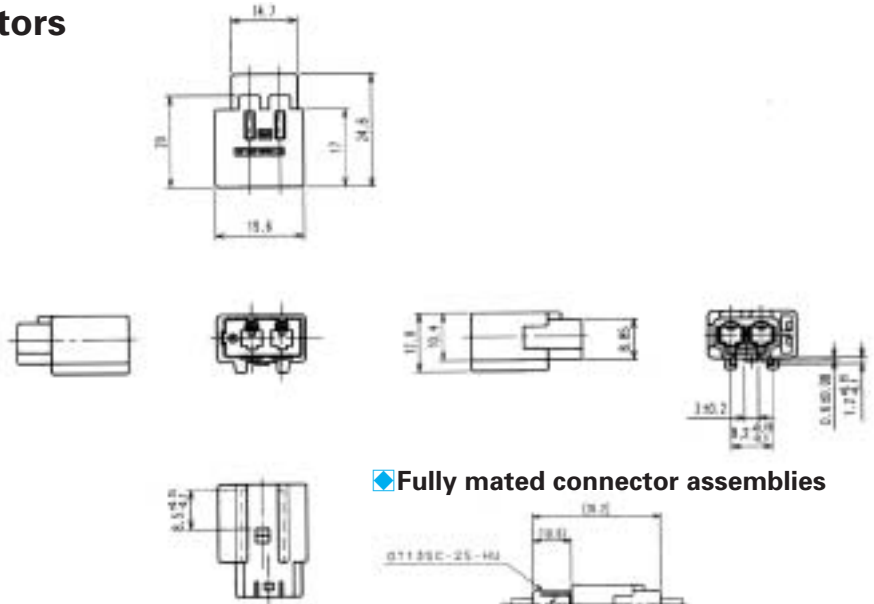

Part Number	CL No.	Material	Color
GT13SCN-2PP-HU	763-0046-1	PBT	Gray

Fully mated connector assemblies

M Connectors (Two Single-Conductor Coaxial Cables + One Power contact)

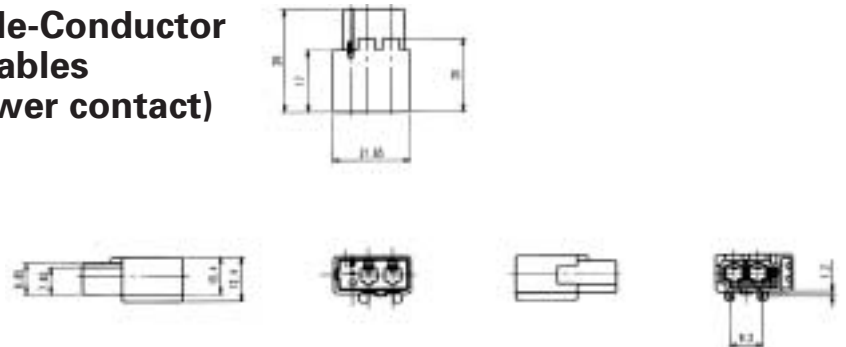

Part Number	CL No.	Material	Color
GT13SCN-2/1PP-HU	763-0038-3	PBT	Gray

Fully mated connector assemblies

* GT10SC-2022PCF is used for power supply terminals.

Retainer (Used with GT13SCN-2/1PP-HU)

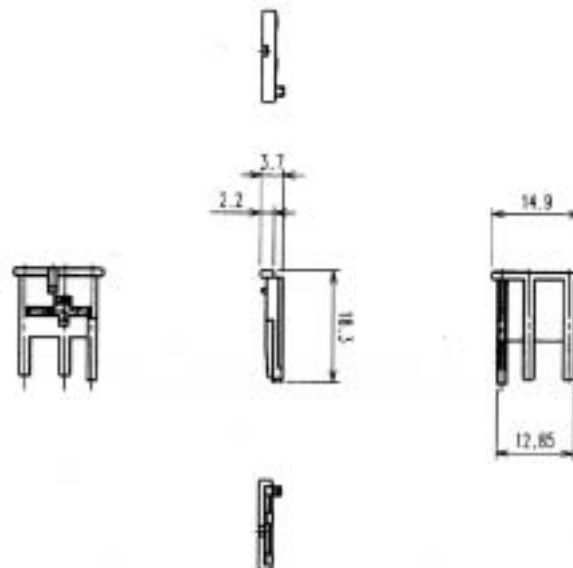

Part Number	CL No.	Material	Color
GT13SC-2/1PP-R	763-0040-5	PBT	Dark Gray

Printed Circuit Board Type



Part Number	CL No.
GT13SC-1/1PP-DS	763-0009-5

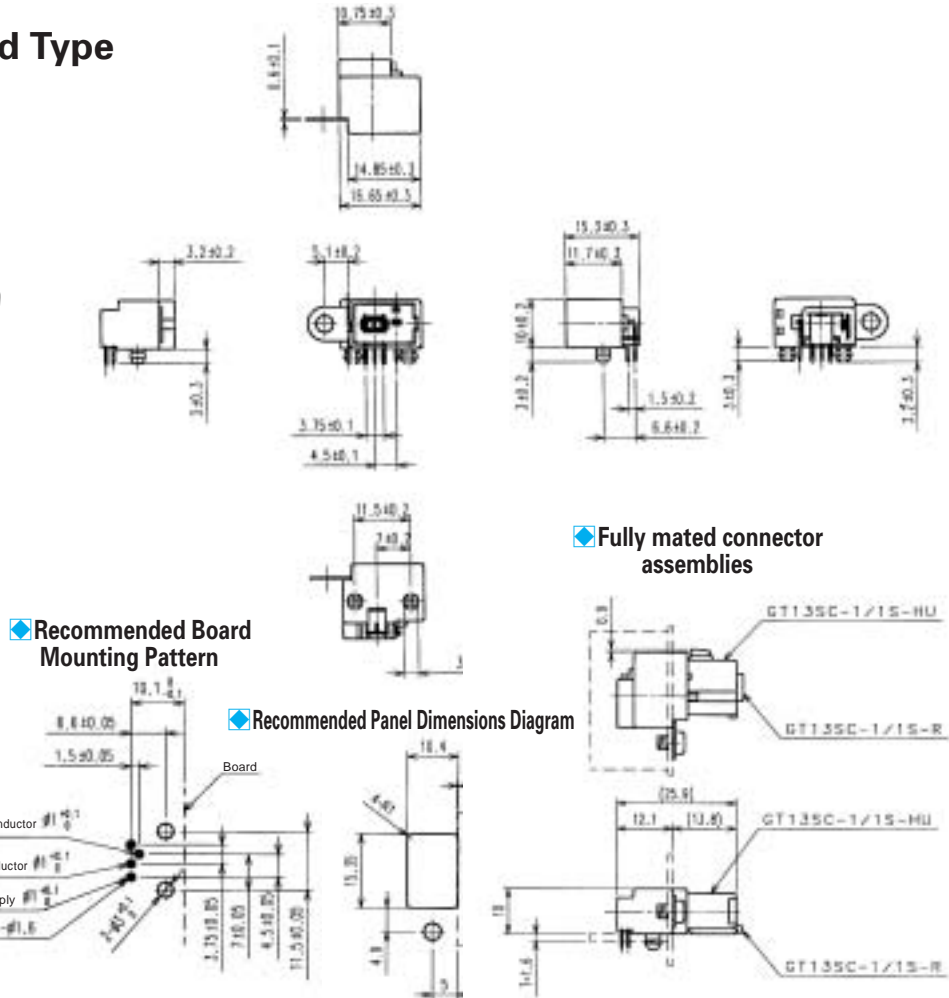

Printed Circuit Board Type (2 Position)



Part Number	CL No.	Material	Color
GT13SC-2PP-DS	763-0013-2	PBT	Gray
GT13SC-2PP-DS (A)	763-0034-2	PBT	Brown
GT13SC-2PP-DS (B)	763-0035-5	PBT	Green

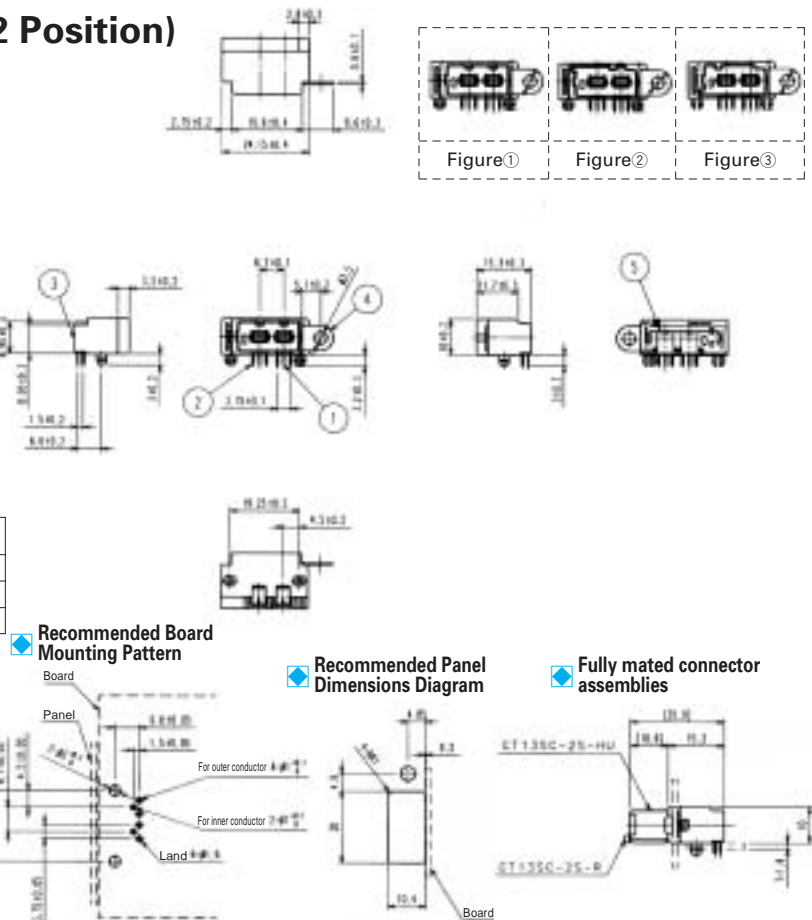

**Printed Circuit Board Type
(Two Single-Conductor Coaxial Cables
+ One Power contact)**



Recommended Board Mounting Pattern

Recommended Panel Dimensions Diagram

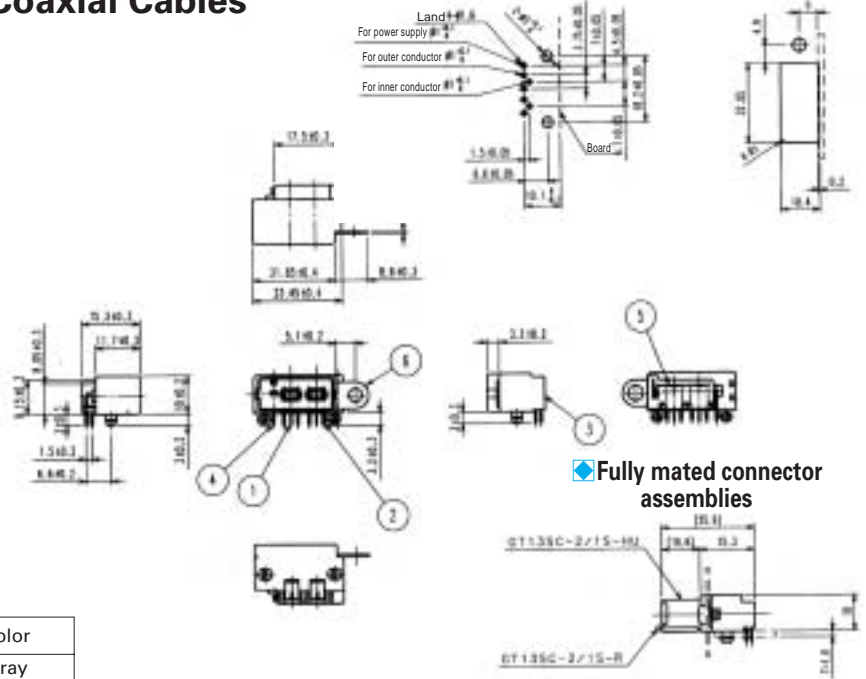

Part Number	CL No.	Material	Color
GT13SC-2/1PP-DS	763-0018-6	PBT	Gray

**Printed Circuit Board Type
(4 Single-Conductor Coaxial Cables
+ One Power contact)**

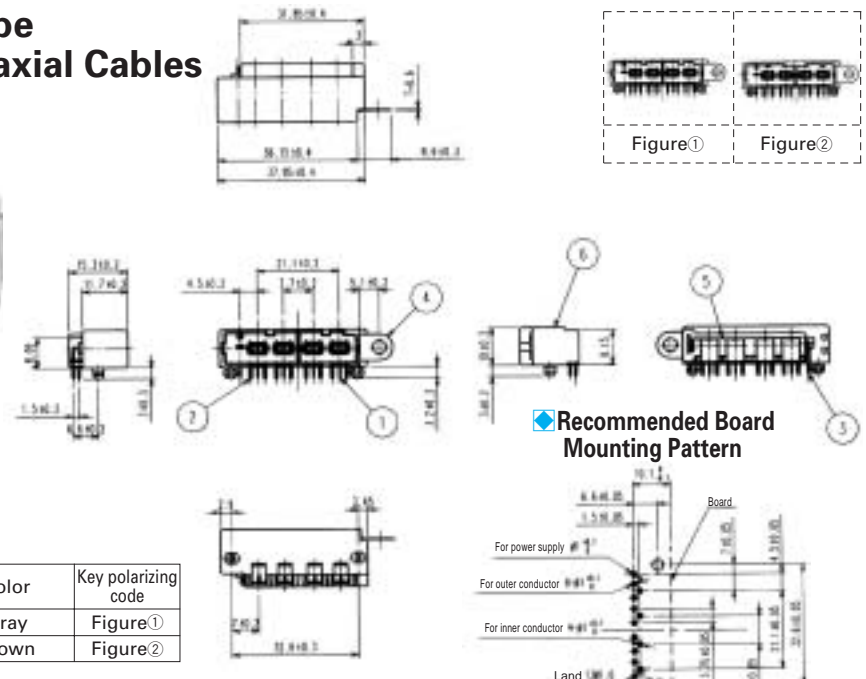
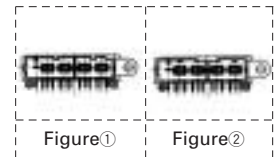

Part Number	CL No.	Material	Color	Key polarizing code
GT13SC-4/1PP-DS	763-0019-9	PBT	Gray	Figure 1
GT13SC-4/1PP-DS (A)	763-0020-8	PBT	Brown	Figure 2

Recommended Panel Dimensions Diagram

Fully mated connector assemblies

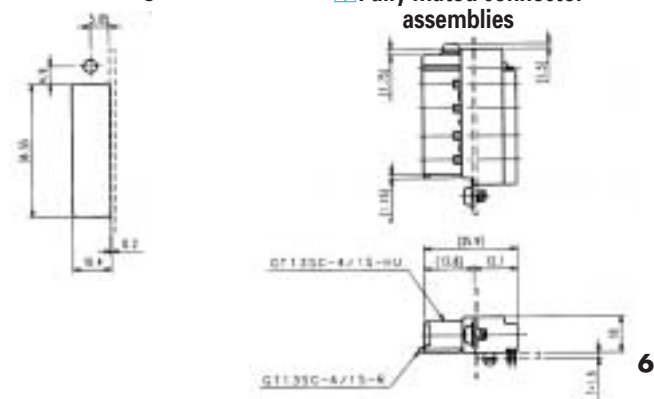

◆ Termination Tools

User's manuals are available. Please contact a Hirose Electric account representative.

Automatic Crimping Machine



Part Number CM-105

Specifications

Item	Specification	Remarks
Specification	1.5tons	
Stroke Length	30mm	
Number of strokes	200spm (50Hz)	200spm (60Hz)
Weight	75kg	
Motor	0.2kW	100V AC
Crimping speed	2,000-4,000pcs, per day	

* Crimp height setting tables are available for each cable type. Please contact your nearest Hirose Electric account representative.
Different cables will require different crimp height settings.

● **A special reel stand is required.**