



Triple PLL Field Programmable VCXO Clock Synthesizer

Description

The ICS271 field programmable VCXO clock synthesizer generates up to six high-quality, high-frequency clock outputs including multiple reference clocks from a low-frequency crystal input. It is designed to replace crystals and crystal oscillators in most electronic systems.

Using ICS' VersaClock™ software to configure PLLs and outputs, the ICS271 contains a One-Time Programmable (OTP) ROM for field programmability. Programming features include VCXO, eight selectable configuration registers and up to two sets of three low-skew outputs.

Each of the two output groups are powered by a separate VDDO voltage. VDDO may vary from 1.8 V to VDD.

Using Phase-Locked Loop (PLL) techniques, the device runs from a standard fundamental mode, inexpensive crystal, or clock. It can replace VCXOs, multiple crystals and oscillators, saving board space and cost.

The ICS271 is also available in factory programmed custom versions for high-volume applications.

Features

- Packaged as 20-pin TSSOP
- Eight addressable registers
- Replaces multiple crystals and oscillators
- Output frequencies up to 200 MHz at 3.3 V
- Input crystal frequency of 5 to 27 MHz
- Up to six reference outputs
- Separate 1.8 to 3.3 V VDDO output level controls for each bank of 3 outputs
- Up to two sets of three low-skew outputs
- Operating voltages of 3.3 V
- Controllable output drive levels
- Advanced, low-power CMOS process
- Available in Pb (lead) free packaging

Block Diagram

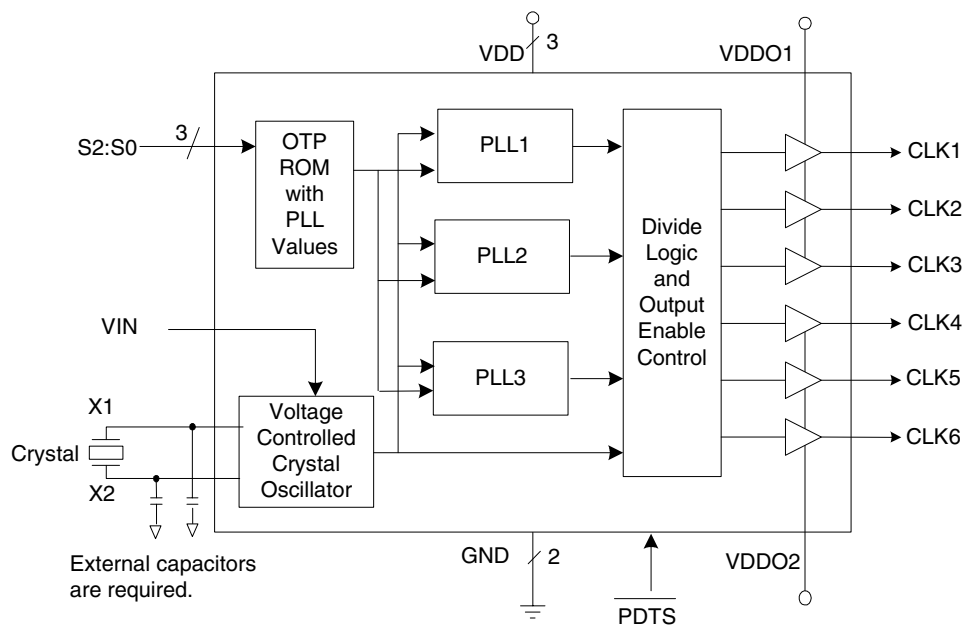



Pin Assignment

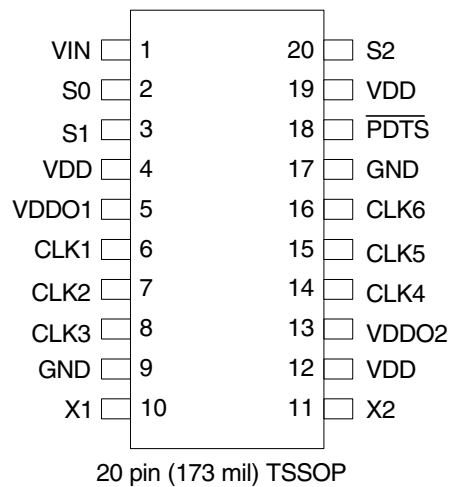

Pin Descriptions

| Pin Number | Pin Name | Pin Type | Pin Description |
|------------|---------------------------------|----------|---|
| 1 | VIN | Input | Voltage input to VCXO. Zero to 3.3 V signal which controls the VCXO frequency |
| 2 | S0 | Input | Select pin 0. Internal pull-up resistor. |
| 3 | S1 | Input | Select pin 1. Internal pull-up resistor. |
| 4 | VDD | Power | Connect to +3.3 V. |
| 5 | VDDO1 | Power | Power supply for outputs CLK1-CLK3. Must not exceed VDD. |
| 6 | CLK1 | Output | Output clock 1. Weak internal pull-down when tri-state. |
| 7 | CLK2 | Output | Output clock 2. Weak internal pull-down when tri-state. |
| 8 | CLK3 | Output | Output clock 3. Weak internal pull-down when tri-state. |
| 9 | GND | Power | Connect to ground. |
| 10 | X1 | XI | Crystal input. Connect this pin to a crystal. |
| 11 | X2 | XO | Crystal Output. Connect this pin to a crystal. |
| 12 | VDD | Power | Connect to +3.3 V. |
| 13 | VDDO2 | Power | Power supply for outputs CLK4-CLK6. Must not exceed VDD. |
| 14 | CLK4 | Output | Output clock 4. Weak internal pull-down when tri-state. |
| 15 | CLK5 | Output | Output clock 5. Weak internal pull-down when tri-state. |
| 16 | CLK6 | Output | Output clock 6. Weak internal pull-down when tri-state. |
| 17 | GND | Power | Connect to ground. |
| 18 | $\overline{\text{PDT}}\text{S}$ | Input | Power-down tri-state. Powers down entire chip and tri-states clock outputs when low. Internal pull-up resistor. |
| 19 | VDD | Power | Connect to +3.3 V. |
| 20 | S2 | Input | Select pin 2. Internal pull-up resistor. |



External Components

The ICS271 requires a minimum number of external components for proper operation.

Series Termination Resistor

Clock output traces over one inch should use series termination. To series terminate a 50Ω trace (a commonly used trace impedance), place a 33Ω resistor in series with the clock line, as close to the clock output pin as possible. The nominal impedance of the clock output is 20Ω.

Decoupling Capacitors

As with any high-performance mixed-signal IC, the ICS271 must be isolated from system power supply noise to perform optimally.

Decoupling capacitors of 0.01μF must be connected between each VDD, VDDO, and the PCB ground plane. For optimum device performance, the decoupling capacitor should be mounted on the component side of the PCB. Avoid the use of vias on the decoupling circuit.

Quartz Crystal

The ICS271 VCXO function consists of the external crystal and the integrated VCXO oscillator circuit. To assure the best system performance (frequency pull range) and reliability, a crystal device with the recommended parameters (shown below) must be used, and the layout guidelines discussed in the following section shown must be followed.

The frequency of oscillation of a quartz crystal is determined by its “cut” and by the load capacitors connected to it. The ICS271 incorporates on-chip variable load capacitors that “pull” (change) the frequency of the crystal. The crystal specified for use with the ICS271 is designed to have zero frequency error when the total of on-chip + stray capacitance is 14 pF.

Recommended Crystal Parameters:

| | |
|--------------------------|----------|
| Initial Accuracy at 25°C | ±20 ppm |
| Temperature Stability | ±30 ppm |
| Aging | ±20 ppm |
| Load Capacitance | 14 pf |
| Shunt Capacitance, C0 | 7 pF Max |
| C0/C1 Ratio | 250 Max |

Equivalent Series Resistance

35Ω Max

The external crystal must be connected as close to the chip as possible and should be on the same side of the PCB as the ICS271. There should be no via's between the crystal pins and the X1 and X2 device pins. There should be no signal traces underneath or close to the crystal. See application note MAN05.

Crystal Tuning Load Capacitors

The crystal traces should include pads for small fixed capacitors, one between X1 and ground, and another between X2 and ground. Stuffing of these capacitors on the PCB is optional. The need for these capacitors is determined at system prototype evaluation, and is influenced by the particular crystal used (manufacture and frequency) and by PCB layout. The typical required capacitor value is 1 to 4 pF.

To determine the need for and value of the crystal adjustment capacitors, you will need a PC board of your final layout, a frequency counter capable of about 1 ppm resolution and accuracy, two power supplies, and some samples of the crystals which you plan to use in production, along with measured initial accuracy for each crystal at the specified crystal load capacitance, CL.

To determine the value of the crystal capacitors:

1. Connect VDD of the ICS271 to 3.3 V. Connect pin 1 of the ICS271 to the second power supply. Adjust the voltage on pin 1 to 0V. Measure and record the frequency of the CLK output.
2. Adjust the voltage on pin 1 to 3.3 V. Measure and record the frequency of the same output.

To calculate the centering error:

$$\text{Error} = 10^6 \times \left[\frac{(f_{3.0V} - f_{\text{target}}) + (f_{0V} - f_{\text{target}})}{f_{\text{target}}} \right] - \text{error}_{\text{xtal}}$$

Where:

f_{target} = nominal crystal frequency



$error_{xtal}$ = actual initial accuracy (in ppm) of the crystal being measured

If the centering error is less than ± 25 ppm, no adjustment is needed. If the centering error is more than 25 ppm negative, the PC board has excessive stray capacitance and a new PCB layout should be considered to reduce stray capacitance. (Alternately, the crystal may be re-specified to a higher load capacitance. Contact ICS for details.) If the centering error is more than 25 ppm positive, add identical fixed centering capacitors from each crystal pin to ground. The value for each of these caps (in pF) is given by: External Capacitor = $2 \times (\text{centering error}) / (\text{trim sensitivity})$

Trim sensitivity is a parameter which can be supplied by your crystal vendor. If you do not know the value, assume it is 30 ppm/pF. After any changes, repeat the measurement to verify that the remaining error is acceptably low (typically less than ± 25 ppm).

ICS271 Configuration Capabilities

The architecture of the ICS271 allows the user to easily configure the device to a wide range of output frequencies, for a given input reference frequency.

The frequency multiplier PLL provides a high degree of precision. The M/N values (the multiplier/divide values available to generate the target VCO frequency) can be set within the range of $M = 1$ to 1024 and $N = 1$ to 32,895.

The ICS271 also provides separate output divide values, from 2 through 63, to allow the two output clock banks to support widely differing frequency values from the same PLL.

Absolute Maximum Ratings

Stresses above the ratings listed below can cause permanent damage to the ICS271. These ratings, which are standard values for ICS commercially rated parts, are stress ratings only. Functional operation of the device at these or any other conditions above those indicated in the operational sections of the specifications is not implied. Exposure to absolute maximum rating conditions for extended periods can affect product reliability. Electrical parameters are guaranteed only over the recommended operating temperature range.

| Parameter | Condition | Min. | Typ. | Max. | Units |
|---------------------|-------------------|------|------|---------|-------|
| Supply Voltage, VDD | Referenced to GND | | | 7 | V |
| Inputs | Referenced to GND | -0.5 | | VDD+0.5 | V |
| Clock Outputs | Referenced to GND | -0.5 | | VDD+0.5 | V |

Each output frequency can be represented as:

$$\text{OutputFreq} = \text{REFFreq} \cdot \frac{M}{N}$$

Each output clock bank has an separate voltage drive control pin (VDDO1 and VDDO2) that sets the output clock voltage swing.

Output Drive Control

The ICS271 has two output drive settings. For VDDO=VDD, low drive should be selected when outputs are less than 100 MHz. High drive should be selected when outputs are greater than 100 MHz.

For VDDO < 2.8 V, high drive should be selected for all output frequencies.

(Consult the AC Electrical Characteristics for output rise and fall times for each drive option.)

ICS VersaClock Software

ICS applies years of PLL optimization experience into a user friendly software that accepts the user's target reference clock and output frequencies and generates the lowest jitter, lowest power configuration, with only a press of a button. The user does not need to have prior PLL experience or determine the optimal VCO frequency to support multiple output frequencies.

VersaClock software quickly evaluates accessible VCO frequencies with available output divide values and provides an easy to understand, bar code rating for the target output frequencies. The user may evaluate output accuracy, performance trade-off scenarios in seconds.



| Parameter | Condition | Min. | Typ. | Max. | Units |
|-----------------------|----------------|------|------|------|-------|
| Storage Temperature | | -65 | | 150 | °C |
| Soldering Temperature | Max 10 seconds | | | 260 | °C |
| Junction Temperature | | | | 125 | °C |

Recommended Operation Conditions

| Parameter | Min. | Typ. | Max. | Units |
|---|-----------------|------|--------|-------|
| Ambient Operating Temperature (ICS271PG/PGLF) | 0 | | +70 | °C |
| Ambient Operating Temperature (ICS271PGI/PGILF) | -40 | | +85 | °C |
| Power Supply Voltage (measured in respect to GND) | +3.135 | +3.3 | +3.465 | V |
| Power Supply Ramp Time | | | 4 | ms |
| Reference crystal parameters | Refer to page 3 | | | |

DC Electrical Characteristics

Unless stated otherwise, VDD, VDDO = 3.3 V ±5%, Ambient Temperature -40 to +85°C

| Parameter | Symbol | Conditions | Min. | Typ. | Max. | Units |
|--|-----------------|---|-----------------|------|---------|-------|
| Operating Voltage | VDD | | 3.135 | | 3.465 | V |
| VDDO Voltage | | VDDO1 and VDDO2 | 1.80 | | VDD | V |
| Operating Supply Current Input High Voltage | IDD | Config. Dependent - See VersaClock™ Estimates. | | | | mA |
| | | Six 33.3333 MHz outs, VDD=VDDO=3.3 V; PDTs = 1, no load, Note 1 | | 25 | | mA |
| | | PDTs = 0, no load | | 500 | | μA |
| Input High Voltage | V _{IH} | S2:S0 | VDD/2+1 | | | V |
| Input Low Voltage | V _{IL} | S2:S0 | | | 0.4 | V |
| Input High Voltage, $\overline{\text{PDTs}}$ | V _{IH} | | VDD-0.5 | | | V |
| Input Low Voltage, $\overline{\text{PDTs}}$ | V _{IL} | | | | 0.4 | V |
| Input High Voltage | V _{IH} | ICLK | VDD/2+1 | | | V |
| Input Low Voltage | V _{IL} | ICLK | | | VDD/2-1 | V |
| Output High Voltage (CMOS High) | V _{OH} | I _{OH} = -4 mA | VDD-0.4 | | | V |
| Output High Voltage | V _{OH} | I _{OH} = -8 mA (Low Drive); I _{OH} = -12 mA (High Drive) | 2.4 VDDO-0.4 | | | V |
| Output Low Voltage | V _{OL} | I _{OL} = 8 mA (Low Drive); I _{OL} = 12 mA (High Drive) | | | 0.4 | V |
| Short Circuit Current | I _{OS} | Low Drive | | ±40 | | mA |
| | | High Drive | | ±70 | | |
| Nom. Output Impedance | Z _O | | | 20 | | Ω |



| Parameter | Symbol | Conditions | Min. | Typ. | Max. | Units |
|-----------------------------|------------------|---|------|------|------|------------|
| Internal pull-up Resistor | R _{PUS} | S2:S0, $\overline{\text{PDT}}\overline{\text{S}}$ | | 190 | | k Ω |
| Internal pull-down Resistor | R _{PD} | CLK outputs | | 120 | | k Ω |
| Input Capacitance | C _{IN} | Inputs | | 4 | | pF |

Note 1: Example with 25 MHz crystal input with six outputs of 33.3 MHz, no load, and VDD = 3.3 V.

AC Electrical Characteristics

Unless stated otherwise, VDD, VDDO = 3.3 V \pm 5%, Ambient Temperature -40 to +85° C

| Parameter | Symbol | Conditions | Min. | Typ. | Max. | Units |
|---------------------------------------|-----------------|--|-------|-----------|------|-------|
| Input Frequency | F _{IN} | Fundamental crystal | 5 | | 27 | MHz |
| Output Frequency | | VDDO=VDD | 0.314 | | 200 | MHz |
| | | 1.8V < VDDO < 2.8 | 0.314 | | 150 | MHz |
| Crystal Pullability | F _P | 0V \leq V _{IN} \leq 3.3 V, Note 1, Config. Dependent | 100 | | | ppm |
| VCXO Gain | | V _{IN} = VDD/2 \pm 1 V, Note 1, Config. Dependent | | 120 | | ppm/V |
| Output Rise/Fall Time | t _{OF} | 80% to 20%, high drive, Note 2 | | 1.0 | | ns |
| Output Rise/Fall Time | t _{OF} | 80% to 20%, low drive, Note 2 | | 2.0 | | ns |
| Output Clock Duty Cycle, VDDO = 3.3 V | | Note 3 | 40 | 49-51 | 60 | % |
| Power-up time | | PLL lock-time from power-up | | 4 | 10 | ms |
| | | $\overline{\text{PDT}}\overline{\text{S}}$ goes high until stable CLK output | | 0.6 | 2 | ms |
| One Sigma Clock Period Jitter | | Configuration Dependent | | 50 | | ps |
| Maximum Absolute Jitter | t _{ja} | Deviation from Mean. Configuration Dependent | | \pm 200 | | ps |
| Pin-to-Pin Skew | | Low Skew Outputs | -250 | | 250 | ps |

Note 1: External crystal device must conform with Pullable Crystal Specifications listed on page 3.

Note 2: Measured with 15 pF load, VDDO = 3.3 V at VDDO/2.

Note 3: Duty Cycle is configuration dependent. Most configurations are min 45% / max 55%



Thermal Characteristics

| Parameter | Symbol | Conditions | Min. | Typ. | Max. | Units |
|--|---------------|----------------|------|------|------|-------|
| Thermal Resistance Junction to Ambient | θ_{JA} | Still air | | 93 | | °C/W |
| | θ_{JA} | 1 m/s air flow | | 78 | | °C/W |
| | θ_{JA} | 3 m/s air flow | | 65 | | °C/W |
| Thermal Resistance Junction to Case | θ_{JC} | | | 20 | | °C/W |

Marking Diagrams

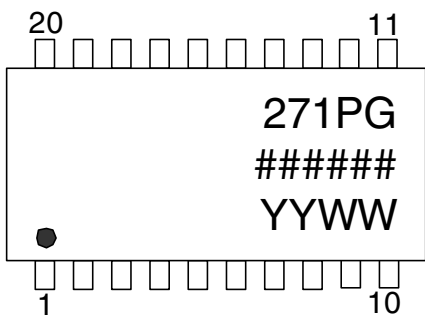

Marking Diagrams (Pb free)

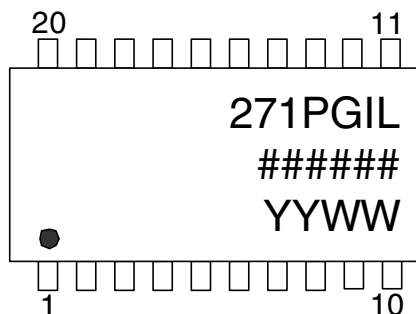
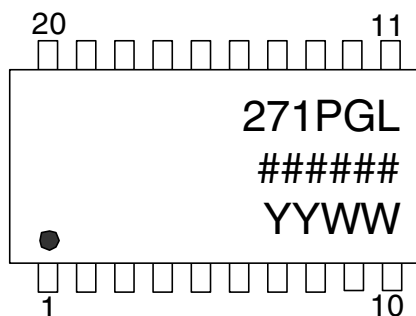

Notes:

1. ##### is the lot number.
2. YYWW is the last two digits of the year and week that the part was assembled.
3. "I" denotes industrial temperature range (if applicable).
4. "L" denotes Pb (lead) free package.
5. Bottom marking: country of origin.



Package Outline and Package Dimensions (20-pin TSSOP, 173 Mil. Body)

Package dimensions are kept current with JEDEC Publication No. 95

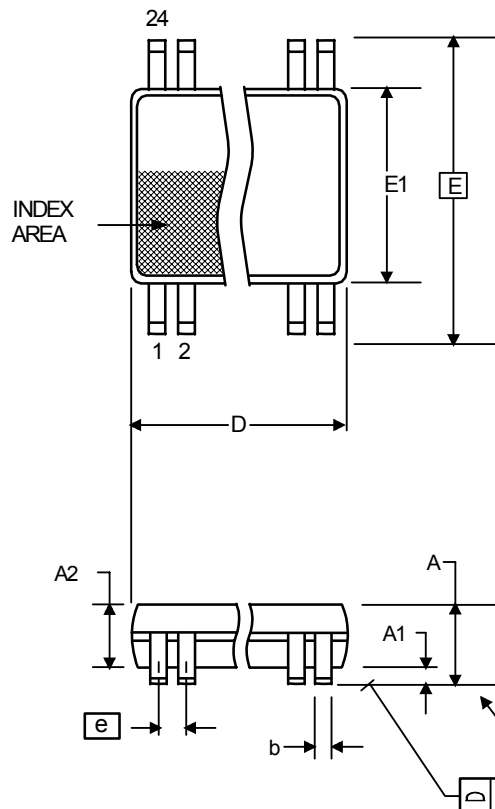

| Symbol | Millimeters | | Inches | |
|----------|-------------|------|--------------|-------|
| | Min | Max | Min | Max |
| A | — | 1.20 | — | .047 |
| A1 | 0.05 | 0.15 | 0.002 | 0.006 |
| A2 | 0.80 | 1.05 | 0.032 | 0.041 |
| b | 0.19 | 0.30 | 0.007 | 0.012 |
| C | 0.09 | 0.20 | 0.0035 | 0.008 |
| D | 6.40 | 6.60 | 0.252 | 0.260 |
| E | 6.40 BASIC | | 0.252 BASIC | |
| E1 | 4.30 | 4.50 | 0.169 | 0.177 |
| e | 0.65 Basic | | 0.0256 Basic | |
| L | 0.45 | 0.75 | .018 | .030 |
| α | 0° | 8° | 0° | 8° |

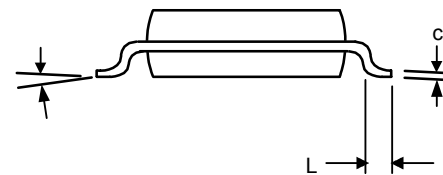

Ordering Information

| Part / Order Number | Marking | Shipping Packaging | Package | Temperature |
|---------------------|------------|--------------------|--------------|--------------|
| ICS271PG | See page 7 | Tubes | 20-pin TSSOP | 0 to +70°C |
| ICS271PGI | | Tubes | 20-pin TSSOP | -40 to +85°C |
| ICS271PGLF | | Tubes | 20-pin TSSOP | 0 to +70°C |
| ICS271PGILF | | Tubes | 20-pin TSSOP | -40 to +85°C |

Parts that are ordered with a "LF" suffix to the part number are the Pb-Free configuration and are RoHS compliant.

While the information presented herein has been checked for both accuracy and reliability, Integrated Circuit Systems (ICS) assumes no responsibility for either its use or for the infringement of any patents or other rights of third parties, which would result from its use. No other circuits, patents, or licenses are implied. This product is intended for use in normal commercial applications. Any other applications such as those requiring extended temperature range, high reliability, or other extraordinary environmental requirements are not recommended without additional processing by ICS. ICS reserves the right to change any circuitry or specifications without notice. ICS does not authorize or warrant any ICS product for use in life support devices or critical medical instruments.

VersaClock™ is a trademark of Integrated Circuit Systems, Inc. All rights reserved.