

# **ID343K01**

## Flash Miniature Card

### 16M

(Model No.: ID343K01)

Spec No.: U810006  
Issue Date: December 8, 1998

---

● Handle this document carefully for it contains material protected by international copyright law. Any reproduction, full or in part, of this material is prohibited without the express written permission of the company.

● When using the products covered herein, please observe the conditions written herein and the precautions outlined in the following paragraphs. In no event shall the company be liable for any damages resulting from failure to strictly adhere to these conditions and precautions.

(1) The products covered herein are designed and manufactured for the following application areas. When using the products covered herein for the equipment listed in Paragraph (2), even for the following application areas, be sure to observe the precautions given in Paragraph (2). Never use the products for the equipment listed in Paragraph (3).

- Office electronics
- Instrumentation and measuring equipment
- Machine tools
- Audiovisual equipment
- Home appliances
- Communication equipment other than for trunk lines

(2) Those contemplating using the products covered herein for the following equipment which demands high reliability, should first contact a sales representative of the company and then accept responsibility for incorporating into the design fail-safe operation, redundancy, and other appropriate measures for ensuring reliability and safety of the equipment and the overall system.

- Control and safety devices for airplanes, trains, automobiles, and other transportation equipment
- Mainframe computers
- Traffic control systems
- Gas leak detectors and automatic cutoff devices
- Rescue and security equipment
- Other safety devices and safety equipment, etc.

(3) Do not use the products covered herein for the following equipment which demands extremely high performance in terms of functionality, reliability, or accuracy.

- Aerospace equipment
- Communications equipment for trunk lines
- Control equipment for the nuclear power industry
- Medical equipment related to life support, etc.

(4) Please direct all queries and comments regarding the interpretation of the above three Paragraphs to a sales representative of the company.

● Please direct all queries regarding the products covered herein to a sales representative of the company.

## Contents

|   |    |    |
|---|----|----|
| 1. General Descriptions .....                       | P. | 3  |
| 2. Features .....                                   | P. | 3  |
| 3. Block Diagram .....                              | P. | 4  |
| 4. Pin Connections .....                            | P. | 5  |
| 5. Signal Description .....                         | P. | 6  |
| 6. LH28F320S5B Control Logic .....                  | P. | 7  |
| 6. 1 Bus Operations .....                           | P. | 7  |
| 6. 1. 1 Read Array .....                            | P. | 7  |
| 6. 1. 2 Output Disable .....                        | P. | 7  |
| 6. 1. 3 Standby .....                               | P. | 7  |
| 6. 1. 4 Deep Power-Down .....                       | P. | 7  |
| 6. 1. 5 Read Identifier Codes Operation .....       | P. | 8  |
| 6. 1. 6 Query Operation .....                       | P. | 8  |
| 6. 1. 7 CUI Write .....                             | P. | 8  |
| 7. Card Control Logic .....                         | P. | 9  |
| 7. 1 Word Addressing .....                          | P. | 9  |
| 7. 2 Decode Logic .....                             | P. | 9  |
| 7. 3 Write Protect Switch .....                     | P. | 9  |
| 7. 3 Data Control .....                             | P. | 10 |
| 8. Command Definitions .....                        | P. | 11 |
| 8. 1 Read Array Command .....                       | P. | 13 |
| 8. 2 Read Identifier Codes Command .....            | P. | 13 |
| 8. 3 Read Status Register Command .....             | P. | 14 |
| 8. 4 Clear Status Register Command .....            | P. | 14 |
| 8. 5 Query Command .....                            | P. | 14 |
| 8. 5. 1 Block Status Register .....                 | P. | 15 |
| 8. 5. 2 CFI Query Identification String .....       | P. | 15 |
| 8. 5. 3 System Interface Information .....          | P. | 16 |
| 8. 5. 4 Device Geometry Definition .....            | P. | 16 |
| 8. 5. 5 SCS OEM Specific Extended Query Table ..... | P. | 17 |
| 8. 6 Block Erase Command .....                      | P. | 18 |
| 8. 7 Full Chip Erase Command .....                  | P. | 18 |
| 8. 8 Word/Byte Write Command .....                  | P. | 19 |
| 8. 9 Multi Word/Byte Write Command .....            | P. | 19 |

|          |  |       |
|----------|--|-------|
| 8. 10    | Block Erase Suspend Command.....                         | P. 20 |
| 8. 11    | (Multi) Word/Byte Write Suspend Command .....            | P. 20 |
| 8. 12    | Status Register .....                                    | P. 21 |
| 8. 13    | Automated Word/Byte Write Flowchart .....                | P. 23 |
| 8. 14    | Multi Word/Byte Write Flowchart .....                    | P. 24 |
| 8. 15    | Automated Block Erase Flowchart .....                    | P. 25 |
| 8. 16    | Automated Full Chip Erase Flowchart .....                | P. 26 |
| 9.       | Electrical Specifications .....                          | P. 27 |
| 9. 1     | Absolute Maximum Ratings .....                           | P. 27 |
| 9. 2     | Recommended Operating Conditions .....                   | P. 27 |
| 9. 3     | Capacitance .....  | P. 27 |
| 9. 4     | AC Input/Output Test Conditions .....                    | P. 27 |
| 10.      | DC Characteristics .....                                 | P. 28 |
| 11.      | AC Characteristics .....                                 | P. 29 |
| 11. 1    | Read Operations .....                                    | P. 29 |
| 11. 2    | AC Waveforms for Read Operations .....                   | P. 29 |
| 11. 3    | Write Operations .....                                   | P. 30 |
| 11. 3. 1 | WE# Controlled Write Operations .....                    | P. 30 |
| 11. 3. 2 | CE# Controlled Write Operations .....                    | P. 30 |
| 11. 3. 3 | AC Waveforms for Write Operations (WE# Controlled) ..... | P. 31 |
| 11. 3. 4 | AC Waveforms for Write Operations (CE# Controlled) ..... | P. 32 |
| 11. 4    | Erase and Data Write Performance .....                   | P. 33 |
| 11. 5    | Power-Up/Power-Down .....                                | P. 34 |
| 12.      | Specification Changes .....                              | P. 35 |
| 13.      | Other Precautions .....                                  | P. 35 |
| 14.      | External Diagrams .....                                  | P. 36 |
| 15.      | Packing Specification .....                              | P. 37 |
| 16.      | External Appearances .....                               | P. 38 |

## 1. General Descriptions

The SHARP ID343K01, which panel design is SHARP standard, is a 16MB Flash Memory Miniature Card conforms to Miniature Card Specification Release 1.1 and is offered to customers giving aim to confirm an external shape or electrical performances of the card. Before mass production, we will create a new product name dedicated for a customer and also present a specification which implies customer's request including panel design.

## 2. Features

|      |  |  |
|------|--|--|
| 2.1  | Type                                       | 16MB Flash Memory Miniature Card<br>(Conforms to Miniature Card Specification Release 1.1)   |
| 2.2  | Memory Capacity                            |  |
|      | Main Memory                                | 8M words × 16 bits (16M words × 8 bits)  |
| 2.3  | Supply Voltage                             | 5.0V ± 5%  |
| 2.4  | Erase Unit                                 | 64K word Blocks  |
| 2.5  | Program/Erase Cycles                       | 100,000 cycles per Block   |
| 2.6  | Interface                                  | Parallel I/O Interface   |
| 2.7  | Function Table                             | See Function Table in page. 10   |
| 2.8  | External Dimensions                        | 33.0 × 38.0 × 3.5 mm   |
| 2.9  | Pin Connections                            | See Pin Connections in page. 5   |
| 2.10 | Type of Connector                          | Conforms to Miniature Card Specification Release 1.1 Card Use Connector  |
| 2.11 | Average Weight                             | 9g   |
| 2.12 | Operating<br>Temp. Range                   | 0 to 60°C  |
| 2.13 | Storage<br>Temp. Range                     | -30 to 70°C  |
| 2.14 | External Appearance                        | External appearance shall be free of any dirt, cratches and abnormalities that could adversely affect sales.                         |
| 2.15 | Manufacturer's Code                        | The manufacturer's code shall be printed on the Miniature card directly or on the seal which is then attached to the Miniature card. |
| 2.16 | Brand Name                                 | The user's brand name will used.   |
| 2.17 | Not designed for rated radiation hardened. |  |

## 3. Block Diagram

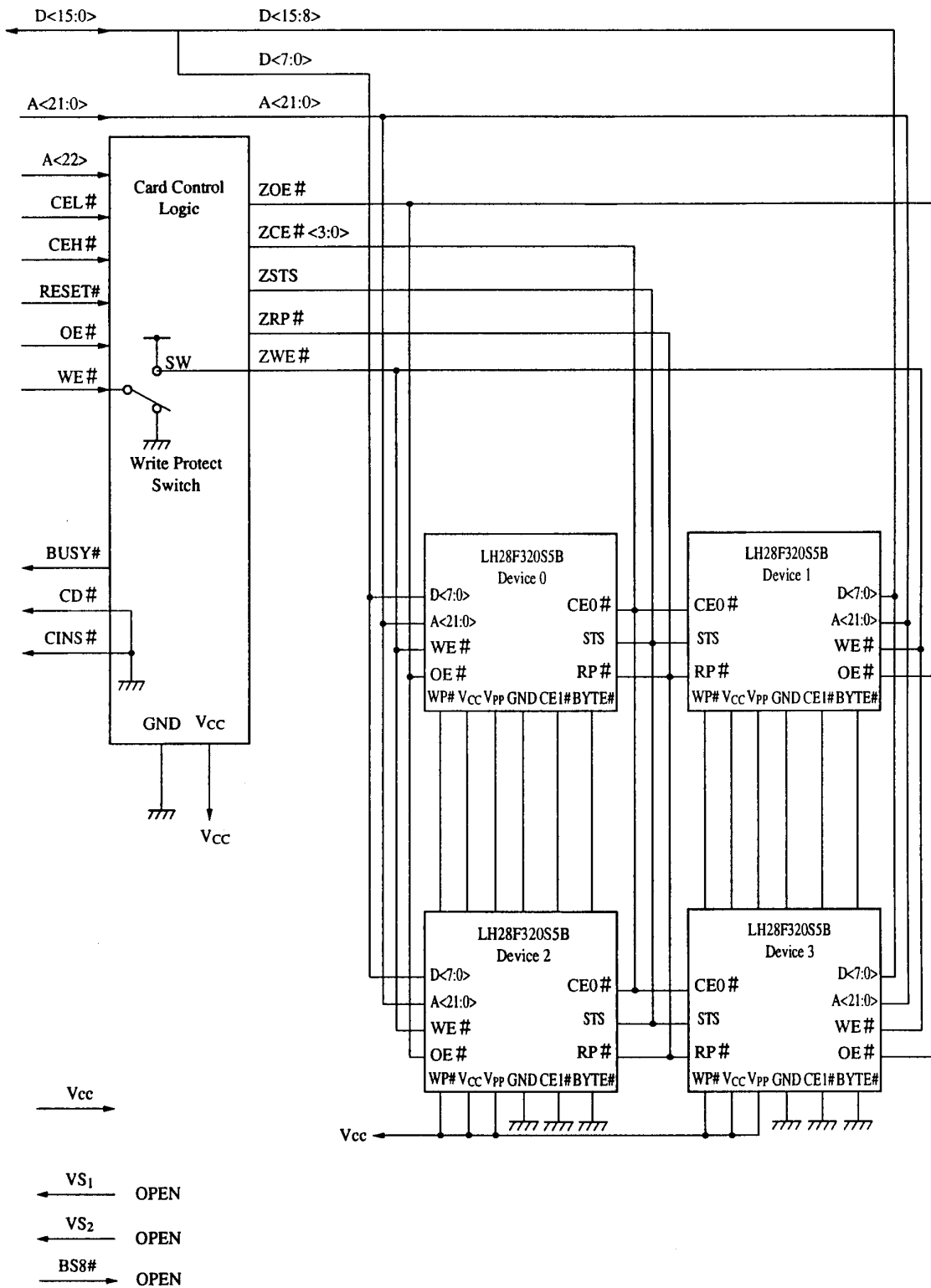

## 4. Pin Connections

| PAD# | SIGNAL           | I/O | FUNCTION                | ACTIVE | PAD# | SIGNAL            | I/O | FUNCTION                        | ACTIVE |
|------|------------------|-----|-------------------------|--------|------|-------------------|-----|---------------------------------|--------|
| 1    | A <sub>18</sub>  | I   | Address Bit 18          |        | 31   | A <sub>19</sub>   | I   | Address Bit 19                  |        |
| 2    | A <sub>16</sub>  | I   | Address Bit 16          |        | 32   | A <sub>17</sub>   | I   | Address Bit 17                  |        |
| 3    | A <sub>14</sub>  | I   | Address Bit 14          |        | 33   | A <sub>15</sub>   | I   | Address Bit 15                  |        |
| 4    | V <sub>ccr</sub> | I   | Voltage Refresh         | N.C.   | 34   | A <sub>13</sub>   | I   | Address Bit 13                  |        |
| 5    | CEH#             | I   | Card Enable High Byte   | Low    | 35   | A <sub>12</sub>   | I   | Address Bit 12                  |        |
| 6    | A <sub>11</sub>  | I   | Address Bit 11          |        | 36   | RESET#            | I   | Reset                           | Low    |
| 7    | A <sub>9</sub>   | I   | Address Bit 9           |        | 37   | A <sub>10</sub>   | I   | Address Bit 10                  |        |
| 8    | A <sub>8</sub>   | I   | Address Bit 8           |        | 38   | VS <sub>1</sub> # | O   | Voltage Sence 1                 | N.C.   |
| 9    | A <sub>6</sub>   | I   | Address Bit 6           |        | 39   | A <sub>7</sub>    | I   | Address Bit 7                   |        |
| 10   | A <sub>5</sub>   | I   | Address Bit 5           |        | 40   | BS8#              | I   | Bus Size 8                      | N.C.   |
| 11   | A <sub>3</sub>   | I   | Address Bit 3           |        | 41   | A <sub>4</sub>    | I   | Address Bit 4                   |        |
| 12   | A <sub>2</sub>   | I   | Address Bit 2           |        | 42   | CEL#              | I   | Card Enable Low Byte            | Low    |
| 13   | A <sub>0</sub>   | I   | Address Bit 0           |        | 43   | A <sub>1</sub>    | I   | Address Bit 1                   |        |
| 14   | RAS#             | I   | Row Address Strobe      | N.C.   | 44   | CASL#             | I   | Column Address Strobe Low Byte  | N.C.   |
| 15   | A <sub>24</sub>  | I   | Address Bit 24          | N.C.   | 45   | CASH#             | I   | Column Address Strobe High Byte | N.C.   |
| 16   | A <sub>23</sub>  | I   | Address Bit 23          | N.C.   | 46   | CD#               | O   | Card Detect                     | Low    |
| 17   | A <sub>22</sub>  | I   | Address Bit 22          |        | 47   | A <sub>21</sub>   | I   | Address Bit 21                  |        |
| 18   | OE#              | I   | Output Enable           | Low    | 48   | BUSY#             | O   | Ready/Busy                      | Low    |
| 19   | D <sub>15</sub>  | I/O | Data Bit 15             |        | 49   | WE#               | I   | Write Enable                    | Low    |
| 20   | D <sub>13</sub>  | I/O | Data Bit 13             |        | 50   | D <sub>14</sub>   | I/O | Data Bit 14                     |        |
| 21   | D <sub>12</sub>  | I/O | Data Bit 12             |        | 51   | RFU               |     | Reserved                        |        |
| 22   | D <sub>10</sub>  | I/O | Data Bit 10             |        | 52   | D <sub>11</sub>   | I/O | Data Bit 11                     |        |
| 23   | D <sub>9</sub>   | I/O | Data Bit 9              |        | 53   | VS <sub>2</sub> # | O   | Voltage Sence 2                 | N.C.   |
| 24   | D <sub>0</sub>   | I/O | Data Bit 0              |        | 54   | D <sub>8</sub>    | I/O | Data Bit 8                      |        |
| 25   | D <sub>2</sub>   | I/O | Data Bit 2              |        | 55   | D <sub>1</sub>    | I/O | Data Bit 1                      |        |
| 26   | D <sub>4</sub>   | I/O | Data Bit 4              |        | 56   | D <sub>3</sub>    | I/O | Data Bit 3                      |        |
| 27   | RFU              |     | Reserved                |        | 57   | D <sub>5</sub>    | I/O | Data Bit 5                      |        |
| 28   | D <sub>7</sub>   | I/O | Data Bit 7              |        | 58   | D <sub>6</sub>    | I/O | Data Bit 6                      |        |
| 29   | SDA              | I/O | Serial Data and Address | N.C.   | 59   | RFU               |     | Reserved                        |        |
| 30   | SCL              | I   | Serial Clock            | N.C.   | 60   | A <sub>20</sub>   | I   | Address Bit 20                  |        |

### Power/Insertion Signals

| SIGNAL NO. | SIGNAL          |
|------------|-----------------|
| 61         | GND             |
| 62         | CINS#           |
| 63         | V <sub>CC</sub> |

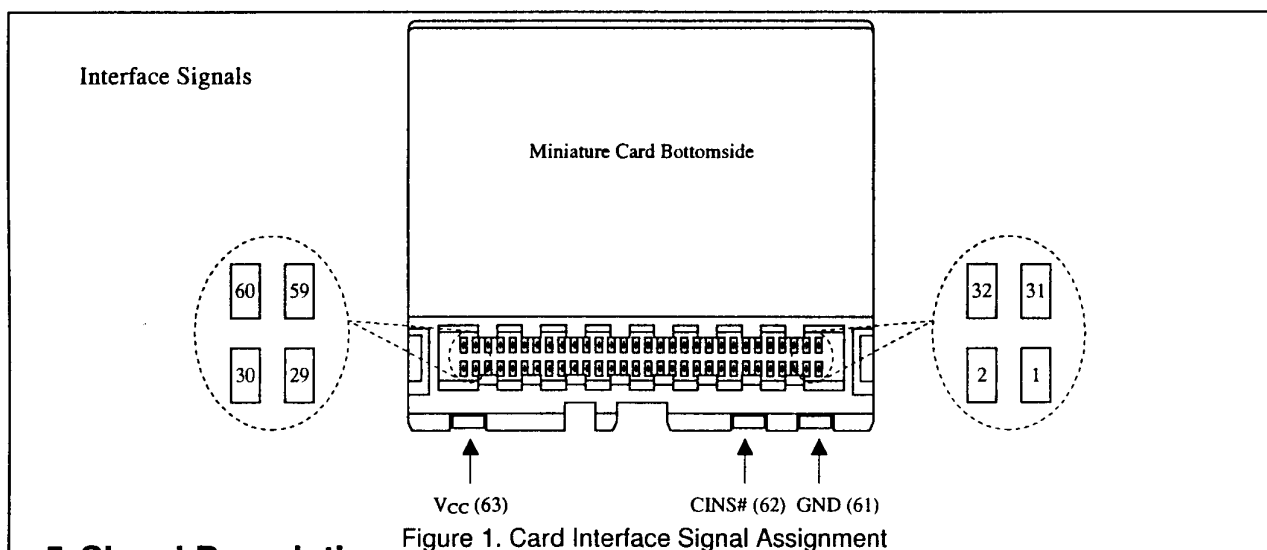

## 5. Signal Description

### Interface Signal Description

| Symbol                                 | Type             | Name and Function  |
|--|------------------|--|
| A <sub>0</sub> -A <sub>24</sub>        | INPUT            | <b>ADDRESS INPUTS:</b> Addresses A <sub>0</sub> through A <sub>24</sub> enable direct addressing of up to 64 MB of memory on the card. The memory will wrap at the card density boundary. The system should NOT try to access memory beyond the card's density, since the upper addresses are not decoded. |
| D <sub>0</sub> -D <sub>15</sub>        | INPUT/<br>OUTPUT | <b>DATA INPUT/OUTPUT:</b> D <sub>0</sub> through D <sub>15</sub> constitute the bi-directional data bus. D <sub>15</sub> is the most significant bit.  |
| CEL#<br>CEH#                           | INPUT            | <b>CARD ENABLE LOW &amp; HIGH:</b> CEL# enables accesses on the low byte of the data bus D <sub>0-7</sub> . CEH# enables accesses on the high byte of the data bus D <sub>8-15</sub> . Both CEL# and CEH# are active low signals. A 16-bit host must always assert both CEL# and CEH#.                     |
| OE#                                    | INPUT            | <b>OUTPUT ENABLE:</b> Active low signal, enables read data from the Miniature card.  |
| WE#                                    | INPUT            | <b>WRITE ENABLE:</b> Active low signal, enables write data to the Miniature card.  |
| BUSY#                                  | OUTPUT           | <b>BUSY:</b> Active low signal, indicates the status of internally timed erase or write activities. A high output indicates the Miniature card is ready to accept another command  |
| CD#                                    | OUTPUT           | <b>CARD DETECT:</b> Active low signal, provides for card insertion detection. CD# connects to ground internally on the Miniature card, and will be forced low when the CD# interface signal connects to the host.  |
| RESET#                                 | INPUT            | <b>RESET:</b> Active low input signal, resets the device's command user interface and places the card into a deep power-down mode. The host must drive this signal.  |
| VS <sub>1</sub> #<br>VS <sub>2</sub> # | OUTPUT           | <b>VOLTAGE SENSE:</b> Notifies the host socket of the card's V <sub>CC</sub> requirements. Both VS <sub>1</sub> # and VS <sub>2</sub> # are left open to indicate a 5.0V capable card has been inserted.   |
| RFU                                    | —                | <b>RESERVED FOR FUTURE USE</b>   |

### Power/Insertion Signal Description

| Symbol          | Type   | Name and Function  |
|-----------------|--------|--|
| CINS#           | OUTPUT | <b>CARD INSERTION DETECT:</b> This signal provides for early card insertion detection. CINS# connects to ground internally on the Miniature card, and will be forced low when the power/insertion signals connect to the host. |
| V <sub>CC</sub> | —      | <b>CARD POWER SUPPLY:</b> 5.0V   |
| GND             | —      | <b>GROUND</b>  |



## 6. LH28F320S5B Control Logic

### 6.1 Bus Operations

The host executes read, write and erase operations by issuing the appropriate command to the flash device's Command User Interface (CUI). The CUI serves as the interface between the host processor and internal operation of the flash device. These commands can be issued to the CUI using standard microprocessor bus cycles.

#### 6.1.1 Read Array

The host enables reads from the card by writing the appropriate read command to the CUI. The LH28F320S5B automatically resets to read array mode upon initial device power-up, or after reset. CEL#, CEH#, and OE# must be logically active to obtain 16 data bits at the outputs. The Card Enables (CEL# and CEH#) are used to select the addressed devices. Output Enable (OE#) is the data input/output (D<sub>0</sub>–D<sub>15</sub>) direction control, and when active, drives data from the selected memory onto the data bus. WE# and RESET# must be driven to V<sub>IH</sub> during a read access.

#### 6.1.2 Output Disable

With OE# at a logic-high level (V<sub>IH</sub>), the device outputs are disabled. Outputs (D<sub>0</sub>–D<sub>15</sub>) are placed in a high-impedance state.

#### 6.1.3 Standby

CEL# and CEH# at a logic-high level (V<sub>IH</sub>) places the card in standby mode. Standby operation disables much of the card's circuitry and substantially reduces device power consumption. The outputs (D<sub>0</sub>–D<sub>15</sub>) are placed in a high-impedance state independent of the status of OE#. If the host deselects the card during a write or erase, the card continues to function and consume normal active power until the operation completes.

#### 6.1.4 Deep Power-Down

RESET# at V<sub>IL</sub> initiates the deep power-down mode.

During reads, an active RESET# deselects the memory, places output drivers in a high-impedance state, and turns off all internal circuits. RESET# must be held low for a minimum of 100 ns. After returning from deep power-down, the host must wait before initial memory access outputs are valid, as determined by t<sub>PHQV</sub>. After this wake-up interval, the host can resume normal operations to the card. Card reset forces the CUI to reset to read array mode and sets the status register to 80H.

During block erase, full chip erase, (multi)word/byte write, or lock-bit configuration modes, an active RESET# will abort the operation. BUSY# remains low until the reset operation completes. Memory contents being altered are no longer valid; the data may be partially erased or written. The host must wait after RESET# goes to logic-High (V<sub>IH</sub>) before it can write another command, as determined by t<sub>PHWL</sub>.

It is important to assert RESET# to the card during a system reset. Automated flash memories provide status information when accessed during block erase, full chip erase, (multi) word/byte write and block-lock-bit configuration. If a CPU reset occurs without a card reset, the host will not be able to read from the card if that card is in a different mode when the system reset occurs. For example, if an end-user initiates a host reset when the card is in read status register mode, the host will attempt to read code from the card, but will actually read status register data.

Sharp's ID343K01 Series Flash Memory Miniature Card allows proper card reset following a system reset through the use of the RESET# input. System RESET# circuitry can reset the host CPU in addition to the card.

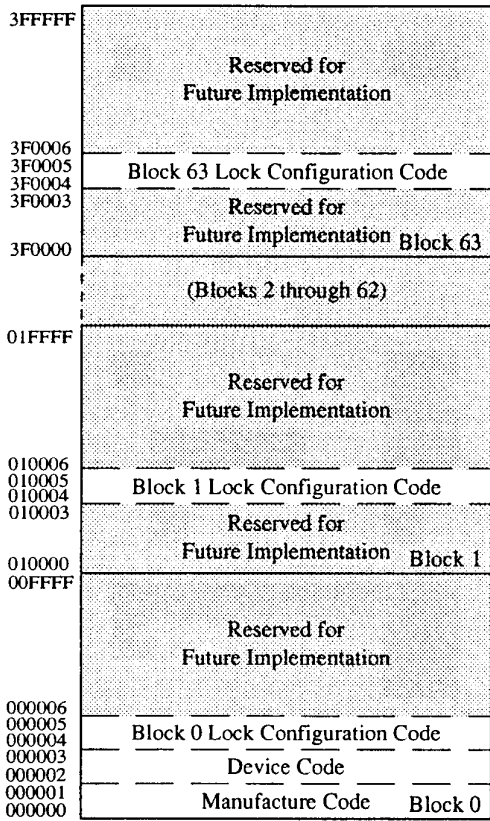

Figure 2. Device Identifier Code Memory Map

### 6. 1. 5 Read Identifier Codes Operation

The read identifier codes operation outputs the manufacturer code (Block 0), device code (Block 0), and block lock configuration codes (for each block), see Figure 2. Using the manufacturer and device codes, the system CPU can automatically match the device with its proper algorithms. The block lock codes identify locked and unlocked blocks.

### 6. 1. 6 Query Operation

The query operation outputs the query structure. Query database is stored in the 48byte ROM. Query structure allows system software to gain critical information for controlling the flash component.

### 6. 1. 7 CUI Writes

Writes to the CUI enable reading of device data and intelligent identifiers. They also control inspection and clearing of the Status Register.

The CUI itself does not occupy an addressable memory location. The interface register is a latch used to store the command, address and data information needed to execute the command. Erase Setup and Erase Confirm commands require both appropriate command data and an address within the block to be erased. The Write Setup command requires both appropriate command data and the address of the location to be written, while the Write command consists of the data to be written and the address of the location to be written.

The CUI is written by bringing WE# to a logic-low level ( $V_{IL}$ ) while CEL#,CEH# is low. Addresses and data are latched on the rising edge of WE#. Standard microprocessor write timings are used.

When a write or erase command has been issued to the CUI, the internal Write State Machine (WSM) becomes busy and will not be ready until it has completed the operation.

## 7. Card Control Logic

### 7.1 Word Addressing

Sharp's ID343K01 Series Flash Memory Miniature Card uses two  $\times 8$  devices in parallel to form the Miniature card  $\times 16$  data bus. If the host writes a command to the card, it must make sure that it writes the command to both devices in the card. For example, a component write command is 40H, so a card write command must be 4040H. This same procedure must be followed when reading from the status register. A component status register is only 8 bits and may return 80H when read. However, the card status register is 16 bits and may return 8080H.

### 7.2 Decode Logic

The decode logic enables the appropriate component device pair during a read or write access. Unused upper addresses for the ID343K01 Series Flash Memory Miniature Card will not be decoded. The address decoding will wrap around at the card's density.

### 7.3 Write Protect Switch

The ID343K01 Series Flash Memory Miniature Card has a write protect switch on the side of the card. When the switch is in the write protect position, the card blocks all writes to the card (see Figure 3).

#### NOTE

When the write protect switch is in the write protect position, all writes are disabled to the flash array including all commands to the CUI.

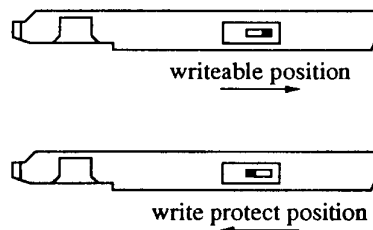

#### NOTE:

The write protect switch is represented by the solid black rectangle.

Figure 3. Write Protect Switch

## 7.4 Data Control

As shown in Table 1, data paths and directions are selected by the Data Control logic using WE#, OE#, CEH#, and CEH#, as logic inputs.

### NOTE:

This card has a  $\times 16$  interface. The High byte CANNOT be accessed on the lower data path (D<sub>0-7</sub>).

| Mode            | RESET#          | CEH#            | CEL#            | OE#             | WE#             | A <sub>0</sub>   | D <sub>8-15</sub>   | D <sub>0-7</sub>   | Notes |
|-----------------|-----------------|-----------------|-----------------|-----------------|-----------------|------------------|---------------------|--------------------|-------|
| Low Byte-Read   | V <sub>IH</sub> | V <sub>IH</sub> | V <sub>IL</sub> | V <sub>IL</sub> | V <sub>IH</sub> | ×                | High-Z              | Low <sup>(6)</sup> | 1.2.3 |
| High Byte-Read  | V <sub>IH</sub> | V <sub>IL</sub> | V <sub>IH</sub> | V <sub>IL</sub> | V <sub>IH</sub> | ×                | High <sup>(6)</sup> | High-Z             | 1.2.3 |
| Word-Read       | V <sub>IH</sub> | V <sub>IL</sub> | V <sub>IL</sub> | V <sub>IL</sub> | V <sub>IH</sub> | ×                | High <sup>(6)</sup> | Low <sup>(6)</sup> | 1.2.3 |
| Low Byte-Write  | V <sub>IH</sub> | V <sub>IH</sub> | V <sub>IL</sub> | V <sub>IH</sub> | V <sub>IL</sub> | ×                | ×××                 | Low <sup>(6)</sup> | 3.4   |
| High Byte-Write | V <sub>IH</sub> | V <sub>IL</sub> | V <sub>IH</sub> | V <sub>IH</sub> | V <sub>IL</sub> | ×                | High <sup>(6)</sup> | ×××                | 3.4   |
| Word-Write      | V <sub>IH</sub> | V <sub>IL</sub> | V <sub>IL</sub> | V <sub>IH</sub> | V <sub>IL</sub> | ×                | High <sup>(6)</sup> | Low <sup>(6)</sup> | 3.4   |
| Manufacturer ID | V <sub>IH</sub> | V <sub>IL</sub> | V <sub>IL</sub> | V <sub>IL</sub> | V <sub>IH</sub> | V <sub>IL</sub>  | B0H                 | B0H                | —     |
| Device ID       | V <sub>IH</sub> | V <sub>IL</sub> | V <sub>IL</sub> | V <sub>IL</sub> | V <sub>IH</sub> | V <sub>IH</sub>  | D4H                 | D4H                | 5     |
| Query           | V <sub>IH</sub> | V <sub>IL</sub> | V <sub>IL</sub> | V <sub>IL</sub> | V <sub>IH</sub> | See Table<br>5~9 | Note<br>7           | Note<br>7          | —     |
| Standby         | V <sub>IH</sub> | V <sub>IH</sub> | V <sub>IH</sub> | ×               | ×               | ×                | High-Z              | High-Z             | —     |
| Output Disable  | V <sub>IH</sub> | ×               | ×               | V <sub>IH</sub> | V <sub>IH</sub> | ×                | High-Z              | High-Z             | —     |
| Power-Down      | V <sub>IL</sub> | ×               | ×               | ×               | ×               | ×                | High-Z              | High-Z             | —     |

Table 1. Function Table

### NOTES:

1. Refer to DC Characteristics.
2. × can be V<sub>IL</sub> or V<sub>IH</sub> for control pins and address.
3. BUSY# is V<sub>OL</sub> when the WSM is executing internal byte write or block erase algorithms. It is V<sub>OH</sub> when the WSM is not busy, in erase suspend mode, or deep power-down mode.
4. Refer to Table 2 for valid D<sub>IN</sub> during a write operation.
5. Although the device code is D4H, other Sharp's Flash Memory Miniature Card could also have device codes AAH, A6H or A7H. Software should check for all four cases for compatibility with future cards.
6. High indicates high byte data, Low indicates low byte data.
7. See section 8.5 for query data.

## 8. Command Definitions

Device operations are selected by writing specific commands into the Command User Interface. Table 2 defines the LH28F320S5B commands.

### NOTE:

When the write protect switch is in the write protect position, all writes are disabled to the flash array including commands to the CUI.

Table 2. Command Definitions <sup>(7)</sup>

| Command  | Bus Cycles<br>Req'd. | Notes | First Bus Cycle     |                     |                     | Second Bus Cycle    |                     |                     |
|--|----------------------|-------|---------------------|---------------------|---------------------|---------------------|---------------------|---------------------|
|  |                      |       | Oper <sup>(1)</sup> | Addr <sup>(2)</sup> | Data <sup>(3)</sup> | Oper <sup>(1)</sup> | Addr <sup>(2)</sup> | Data <sup>(3)</sup> |
| Read Array/Reset   | 1                    | —     | Write               | ×                   | FFFFH               | —                   | —                   | —                   |
| Read Identifier Codes  | ≥2                   | 4     | Write               | ×                   | 9090H               | Read                | IA                  | ID                  |
| Query  | ≥2                   | —     | Write               | ×                   | 9898H               | Read                | QA                  | QD                  |
| Read Status Register   | 2                    | —     | Write               | ×                   | 7070H               | Read                | ×                   | SRD                 |
| Clear Status Register  | 1                    | —     | Write               | ×                   | 5050H               | —                   | —                   | —                   |
| Block Erase Setup /<br>Confirm                               | 2                    |       | Write               | BA                  | 2020H               | Write               | BA                  | D0D0H               |
| Full Chip Erase Setup /<br>Confirm                           | 2                    |       | Write               | ×                   | 3030H               | Write               | ×                   | D0D0H               |
| Word / Byte Write Setup /<br>Write                           | 2                    | 5     | Write               | WA                  | 4040H or<br>1010H   | Write               | WA                  | WD                  |
| Multi Word / Byte Write<br>Setup / Confirm                   | ≥4                   | 6     | Write               | WA                  | E8E8H               | Write               | WA                  | N-1                 |
| Block Erase and (Multi)<br>Word/byte Write Suspend           | 1                    |       | Write               | ×                   | B0B0H               | —                   |                     | —                   |
| Confirm and Block Erase and<br>(Multi)Word/byte Write Resume | 1                    |       | Write               | ×                   | D0D0H               | —                   |                     | —                   |

## NOTES:

1. BUS operations are defined in Table 1.
2. x = Any valid address within the device.  
IA = Identifier Code Address: see Figure 2.  
QA = Query Offset Address.  
BA = Address within the block being erased or locked.  
WA = Address of memory location to be written.
3. SRD = Data read from status register. See Table 10 for a description of the status register bits.  
WD = Data to be written at location WA. Data is latched on the rising edge of WE# or CE# (Whichever goes high first).  
ID = Data read from identifier codes.  
QD = Data read from query database.
4. Following the Read Identifier Codes command, read operations access manufacturer, device and block status codes. See Section 8.2 for read identifier code data.
5. Either 40H or 10H are recognized by the WSM as the byte write setup.
6. Following the Third Bus Cycle, inputs the write address and write data of 'N' times. Finally, input the confirm command 'DODOH'.
7. Commands other than those shown above are reserved by SHARP for future device implementations and should not be used.

## 8.1 Read Array Command

Upon initial device power-up and after exit from deep power-down mode, the card defaults to read array mode. The host can also read by writing the Read Array command. The device remains enabled for reads until the host writes another valid command. Once the internal WSM has started a block erase, full chip erase or (multi) word/byte write, the device will not recognize the Read Array command until the WSM completes its operation. However, the host can suspend the WSM using an Erase Suspend or Word Write Suspend command. RESET# must be  $V_{IH}$ .

## 8.2 Read Identifier Codes Command

The host initiates the identifier code operation by writing the Read Identifier Codes command. Following the command write, read cycles from addresses shown in Figure 2 retrieve the manufacturer, device and block lock configuration codes (see Table 3 for identifier code data). To terminate the operation, write another valid command. Although Table 3 lists the device code as D4D4, other Sharp's Flash Memory Miniature Card could also have device codes AAAA, A6A6 or A7A7. Host software should check for all four cases for compatibility with future cards.

Table 3. Identifier Codes

| Code  | Address             | Data                 |
|---|---------------------|----------------------|
| Manufacture Code                                      | 00000               | B0B0                 |
|   | 00001               |                      |
| Device Code   | 00002               | D4D4                 |
|   | 00003               |                      |
| Block Status Code                                     | $\times 0004^{(1)}$ |                      |
|   | $\times 0005^{(1)}$ |                      |
| • Block is Unlocked                                   |                     | $D_{0,8} = 0$        |
| • Block is Locked (3)                                 |                     | $D_{0,8} = 1$        |
| • Last erase operation completed successfully         |                     | $D_{1,9} = 0$        |
| • Last erase operation did not completed successfully |                     | $D_{1,9} = 1$        |
| • Reserved for Future Use                             |                     | $D_{2-7}, D_{10-15}$ |

**NOTES:**

1.  $\times$  selects the specific block status code to be read. See Figure 2 for the device identifier code memory map.
2. The addresses listed are word addresses and store 16 bits of data.
3. This card is can not lock bit configuration.

### 8.3 Read Status Register Command

The LH28F320S5B components on the ID343K01 Series Flash Memory Miniature Card each contain a Status Register which may be read to determine when a (multi) word/byte write, block erase or full chip erase is complete, and whether that operation completed successfully (see Table 10). The host may read the Status Register at any time by writing the Read Status Register command to the CUI. After writing this command, all subsequent read operations output data from the Status Register, until the host writes another valid command to the CUI. The flash components latch the contents of the Status Register on the falling edge of OE# or CE#, whichever occurs first. OE# or CE# must be toggled to V<sub>IH</sub> before further reads to update the Status Register latch. RESET# must be V<sub>IH</sub>.

**NOTE:**

The ID343K01 Series Flash Memory Miniature Card arranges two LH28F320S5B devices in parallel to from a ×16 bus. Both status registers need to be checked when determining the status of a ×16 erase/write operation.

### 8.4 Clear Status Register Command

The WSM sets the Erase Status and Write Status bits to “1”s and they can only be reset by the Clear Status Register command. These bits indicate various failure conditions(see Table 10). By allowing system software to reset these bits, several operations (such as cumulatively erasing or locking multiple blocks or writing several bytes in sequence) may be performed. The status register may be polled to determine if an error occurs during the sequence.

The WSM sets these bits to “1” when a write or erase operation has failed. The host can issue additional write and erase commands to the CUI without clearing the status register. This allows a system to write a sequence of bytes before checking the write status bit. However, if an error has occurred the system will not know which write in the sequence has failed. To clear the Status Register, the Clear Status Register command (5050H) is written to the CUI.

RESET# must be V<sub>IH</sub>. This command is not functional during block erase, full chip erase, (multi) word/byte write, block erase suspend or (multi) word/byte write suspend modes.

### 8.5 Query Command

Query database can be read by writing Query command (98H). Following the command write, read cycle from address shown in Table 5~ 8 retrieve the critical information to write, erase and otherwise control the flash component. A<sub>0</sub> of query offset address is ignored. RESET# must be V<sub>IH</sub>.

Table 4. Example of Query Output

| Mode     | Offset Address   | Output |       |
|----------|--|--------|-------|
|          |  | DQ15-8 | DQ7-0 |
| × 16Mode | A <sub>5</sub> ,A <sub>4</sub> ,A <sub>3</sub> ,A <sub>2</sub> ,A <sub>1</sub> ,A <sub>0</sub> |        |       |
|          | 1, 0, 0, 0, 0, 0 (20H)   | “Q”    | “Q”   |
|          | 1, 0, 0, 0, 0, 1 (21H)   | “Q”    | “Q”   |
|          | 1, 0, 0, 0, 1, 0 (22H)   | “R”    | “R”   |
|          | 1, 0, 0, 0, 1, 1 (23H)   | “R”    | “R”   |



### 8. 5. 1 Block Status Register

This field provides lock configuration and erase status for the specified block. These informations are only available when device is ready (SR.7=1). If block erase or full chip erase operation is finished irregularly, block erase status bit will be set to "1". If bit 1 is "1", this block is invalid. This card is not support Block lock configuration.

Table 5. Query Block Status Register

| Offset<br>(Word Address) | Length | Description   |
|--------------------------|--------|---|
| (BA+2)H                  | 01H    | Block Status Register<br>bit0 Block Lock Configuration<br>0 = Block is unlocked<br>1 = Block is Locked<br>bit1 Block Erase Status<br>0 = Last erase operation completed successfully<br>1 = Last erase operation not completed successfully<br>bit2-7 reserved for future use |

Note:

1. BA = The beginning of a Block Address.

### 8. 5. 2 CFI Query Identification String

The Identification String provides verification that the component supports the Common Flash Interface specification. Additionally, it indicates which version of the spec and which Vendor-specified command set(s) is (are) supported.

Table 6. CFI Query Identification String

| Offset<br>(Word Address) | Length | Description  |
|--------------------------|--------|--|
| 10H, 11H, 12H            | 03H    | Query Unique ASCII string "QRY"<br>51H, 52H, 59H   |
| 13H, 14H                 | 02H    | Primary Vendor Command Set and Control Interface ID Code<br>01H, 00H (SCS ID Code)                         |
| 15H, 16H                 | 02H    | Address for Primary Algorithm Extended Query Table<br>31H, 00H (SCS Extended Query Table Offset)           |
| 17H, 18H                 | 02H    | Alternate Vendor Command Set and Control Interface ID Code<br>0000H (0000H means that no alternate exists) |
| 19H, 1AH                 | 02H    | Address for Alternate Algorithm Extended Query Table<br>0000H (0000H means that no alternate exists)       |

### 8. 5. 3 System Interface Information

The following device information can be useful in optimizng system interface software.

Table 7. System Information String

| Offset<br>(Word Address) | Length | Description  |
|--------------------------|--------|--|
| 1BH                      | 01H    | V <sub>CC</sub> Logic Supply Minimum Write/Erase voltage<br>45H (4.5V)   |
| 1CH                      | 01H    | V <sub>CC</sub> Logic Supply Maximum Write/Erase voltage<br>55H (5.5V)   |
| 1DH                      | 01H    | V <sub>PP</sub> Programming Supply Minimum Write/Erase voltage<br>45H (4.5V)   |
| 1EH                      | 01H    | V <sub>PP</sub> Programming Supply Maximum Write/Erase voltage<br>55H (5.5V)   |
| 1FH                      | 01H    | Typical Timeout per Single Byte/Word Write<br>04H ( $2^4 = 16 \mu\text{s}$ ), $2^N \mu\text{s}$  |
| 20H                      | 01H    | Typical Timeout for Maximum Size Buffer Write (32 Bytes)<br>06H ( $2^6 = 64 \mu\text{s}$ )   |
| 21H                      | 01H    | Typical Timeout per Individual Block Erase<br>09H ( $09H = 9$ , $2^9 = 512\text{ms}$ )   |
| 22H                      | 01H    | Typical Timeout for Full Chip Erase<br>0FH ( $0FH = 15$ , $2^{15} = 32768\text{ms}$ )  |
| 23H                      | 01H    | Maximum Timeout per Single Byte/Word Write, $2^N$ times of typical.<br>04H ( $2^4 = 16$ , $16 \mu\text{s} \times 16 = 256 \mu\text{s}$ ) |
| 24H                      | 01H    | Maximum Timeout Maximum Size Buffer Write, $2^N$ times of typical.<br>04H ( $2^4 = 16$ , $64 \mu\text{s} \times 16 = 1024 \mu\text{s}$ ) |
| 25H                      | 01H    | Maximum Timeout per Individual Block Erase, $2^N$ times of typical.<br>04H ( $2^4 = 16$ , $1024\text{ms} \times 16 = 16384\text{ms}$ )   |
| 26H                      | 01H    | Maximum Timeout For Full Chip Erase, $2^N$ times of typical.<br>04H ( $2^4 = 16$ , $32768\text{ms} \times 16 = 524288\text{ms}$ )        |

### 8. 5. 4 Device Geometry Definition

This field provides critical details of the flash device geometry.

Table 8. Device Geometry Definition

| Offset<br>(Word Address) | Length | Description   |
|--------------------------|--------|---|
| 27H                      | 01H    | Device Size<br>16H ( $16H = 22$ , $2^{22} = 4194304 = 4\text{M Bytes}$ )  |
| 28H, 29H                 | 02H    | Flash Device Interface description<br>02H, 00H ( $\times 8/\times 16$ supports $\times 8$ and $\times 16$ via BYTE#)  |
| 2AH, 2BH                 | 02H    | Maximum Number of Bytes in Multi-byte<br>05H, 00H ( $2^5 = 32$ Bytes)   |
| 2CH                      | 02H    | Number of Erase Block Regions within device<br>01H (symmetrically blocked)  |
| 2DH, 2EH                 | 02H    | The Number of Erase Blocks<br>3FH, 00H ( $3FH = 63 \Rightarrow 63 + 1 = 64$ Blocks)   |
| 2FH, 30H                 | 02H    | The Number of "256 Bytes" cluster in a Erase block<br>00H, 01H ( $0100H = 256 \Rightarrow 256 \text{ Bytes} \times 256 = 64\text{K Bytes in a Erase Block}$ ) |

### 8. 5. 5 SCS OEM Specific Extended Query Table

Certain flash features and commands may be optional in a vendor-specific algorithm specification. The optional vendor-specific Query table(s) may be used to specify this and other types of information. These structures are defined solely by the flash vendor(s).

Table 9. SCS OEM Specific Extended Query Table

| Offset<br>(Word Address) | Length   | Description   |
|--------------------------|----------|---|
| 31H, 32H, 33H            | 03H      | PRI<br>50H, 52H, 49H  |
| 34H                      | 01H      | 31H (1) Major Version Number, ASCII   |
| 35H                      | 01H      | 30H (0) Minor Version Number, ASCII   |
| 36H, 37H,<br>38H, 39H    | 04H      | 0FH, 00H, 00H, 00H<br>Optional Command Support<br>bit0 = 1 : Chip Erase Supported<br>bit1 = 1 : Suspend Erase Supported<br>bit2 = 1 : Suspend Write Supported<br>bit3 = 1 : Lock/Unlock Supported<br>bit4 = 0 : Queued Erase Not Supported<br>bit5-31 = 0 : reserved for future use |
| 3AH                      | 01H      | 01H<br>Supported Functions after Suspend<br>bit0 = 1 : Write Supported after Erase Suspend<br>bit1-7 = 0 : reserved for future use  |
| 3BH, 3CH                 | 02H      | 03H, 00H<br>Block Status Register Mask<br>bit0 = 1 : Block Status Register Lock Bit [BSR.0] active<br>bit1 = 0 : Block Status Register Valid Bit [BSR.1] active<br>bit2-15 = 0 : reserved for future use  |
| 3DH                      | 01H      | V <sub>CC</sub> Logic Supply Optimum Write/Erase voltage (highest performance)<br>50H (5.0V)  |
| 3EH                      | 01H      | V <sub>PP</sub> Programming Supply Optimum Write/Erase voltage (highest performance)<br>50H (5.0V)  |
| 3FH                      | reserved | Reserved for future versions of the SCS Specification   |

## 8. 6 Block Erase Command

The host executes an erase command one block at a time using a two-cycle command. The host writes a block erase setup command first, followed by a block erase confirm command. These two commands require appropriate sequencing and an address within the block to complete (erase changes all block data to FFH). The WSM handles block preconditioning, erase, and verify internally (invisible to the system). After the host writes the two-cycle block erase sequence, the device automatically outputs status register data when read. The CPU can detect block erase completion by analyzing the output data of the BUSY# signal or status register bit SR.7.

When the block erase completes, status register bit SR.5 should be checked. If a block erase error is detected, the host should clear the status register before system software attempts corrective actions. The CUI remains in read status register mode until the host issues a new command.

This two-step command sequence of set-up followed by execution ensures that block contents are not accidentally erased. An invalid Block Erase command sequence will result in the WSM setting status register bits SR.4 and SR.5 to "1".

## 8. 7 Full Chip Erase Command

This command followed by a confirm command(D0D0H) erases all of the unlocked blocks. A full chip erase setup is first written, followed by a full chip erase confirm. After a confirm command is written, device erases the all unlocked blocks from Block 0 to Block 31 block by block. This command sequence requires appropriate sequencing. Block preconditioning, erase and verify are handled internally by the WSM(invisible to the system). After the two-cycle full chip erase sequence is written, the device automatically outputs status register data when read. The CPU can detect full chip erase completion by analyzing the output data of the BUSY# pin or status register bit SR.7.

When the full chip erase is complete, status register bit SR.5 should be checked. If erase error is detected, the status register should be cleared before system software attempts corrective actions. The CUI remains in read status register mode until a new command is issued. If error is detected on a block during full chip erase operation, WSM stops erasing. Reading the block valid status by issuing Read ID Codes command or Query command informs which blocks failed to its erase.

This two-step command sequence of set-up followed by execution ensures that block contents are not accidentally erased. An invalid Full Chip Erase command sequence will result in both status register bits SR.4 and SR.5 being set to "1".

## 8. 8 Word/Byte Write Command

The host executes a word/byte write by a two-cycle command sequence. The host writes word/byte write setup (standard 4040H or alternate 1010H) first, followed by a second write that specifies the address and data (latched on the rising edge of WE#). The WSM then takes over, controlling the word/byte write and write verify algorithms internally. After the host writes the word/byte write sequence, the device automatically output status register data when read. The CPU can detect the completion of the word/byte write event by analyzing the BUSY# pin or status register bit SR.7.

When the WSM completes the word/byte writes, the host should check status register bit SR.4. If the host detects a write error, it should clear the status register. The internal WSM verify only detects errors for "1"s that do not successfully writes to "0"s. The CUI remains in read status register mode until it receives another command.

## 8. 9 Multi Word/Byte Write Command

Multi word/byte write is executed by at least four-cycle or up to 35-cycle command sequence. Up to 32 bytes can be loaded into the buffer and written to Flash Array. First, multi word/byte write setup (E8H) is written with the write address. At this point, the device automatically outputs extended status register data (XSR) when read. If extended status register bit XSR.7 is 0, no Multi Word/Byte Write command is available and multi word/byte write setup which just has been written is ignored. To retry, continue monitoring XSR.7 by writing multi word/byte write setup with write address until XSR.7 transitions to 1. When XSR.7 transitions to 1, the device is ready for loading the data to the buffer. A word/byte count (N)-1 is written with write address. After writing a word/byte count (N)-1 must be less than or equal to 1FH. On the next write, device start address is written with buffer data. Subsequent writes provide additional device address and data, depending on the count. All subsequent address must lie within the start address plus the count. After the final buffer data is written, write confirm (D0H) must be written. This initiates WSM to begin copying the buffer data to the Flash Array. An invalid Multi Word/Byte Write command sequence will result in both status register bits SR.4 and SR.5 being set to "1". For additional multi word/byte write, write another multi word/byte write setup and check XSR.7. The Multi Word/Byte Write command can be queued while WSM is busy as long as XSR.7 indicates "1", because LH320S5B has two buffers. If an error occurs while writing, the device will stop writing and flash next multi word/byte write command. Status register bit SR.4 will be set to "1". No multi word/byte write command. Status register bit SR.4 will be set to "1". No multi word/byte write command is available if either SR.4 or SR.5 are set to "1". SR.4 and SR.5 should be cleared before issuing multi word/byte write command. If a multi word/byte write command is attempted past an erase block boundary, the device will write the data to Flash Array up to an erase block boundary and then stop writing. Status register bits SR.4 and SR.5 will be set to "1".

## 8. 10 Block Erase Suspend Command

The Block Erase Suspend command allows block-erase interruption to read or write data in another block of memory. Once the block erase process starts, writing the Block Erase Suspend command requests that the WSM suspend the block erase sequence at a predetermined point in the algorithm. After the host writes the Block Erase Suspend command, the host should then write the Read Status Register command. Polling status register bits SR.7 and SR.6 can determine when the WSM suspends the block erase operation (both will be set to "1"). BUSY# will also transition to  $V_{OH}$ . Specification  $t_{WHRH2}$  defines the block erase suspend latency. It is also possible that the block erase completes before the device has an opportunity to suspend. The host should also check for this condition.

After the block erase has been suspended, the host can issue a read array command or a word write command to any block except the one that has been suspended. Using the Word Write Suspend command (see Section 8.11), a word write operation can also be suspended. During a word write operation with block erase suspended, status register bit SR.7 will return to "0" and the BUSY# output will transition to  $V_{OL}$ . However, SR.6 will remain "1" to indicate block erase suspend status. The only other valid commands while block erase is suspended are Read Status Register and Block Erase Resume. After the host writes a Block Erase Resume command to the flash memory, the WSM will continue the block erase process. Status register bits SR.6 and SR.7 will automatically clear and BUSY# will return to  $V_{OL}$ . After the host writes the Erase Resume command, the device automatically outputs status register data when read. Block erase cannot resume until word write operation initiated during block erase suspend have completed.

## 8. 11 (Multi)Word/Byte Write Suspend Command

The (Multi)Word/Byte Write Suspend command allows (multi)word/byte write interruption to read data in other flash memory locations. Once the (multi)word/byte write process starts, writing the (Multi)Word/Byte Write Suspend command requests that the WSM suspend the (multi)word/byte write sequence at a predetermined point in the algorithm. After the host writes the (Multi)Word/Byte Write Suspend command, it should write the Read Status Register command. Polling status register bits SR.7 and SR.2 can determine when the WSM suspends the (multi)word/byte write operation (both will be set to "1"). BUSY# will also transition to  $V_{OH}$ . Specification  $t_{WHRH1}$  defines the (multi)word/byte write suspend latency. It is also possible that the (multi)word/byte write completes before the device has an opportunity to suspend. The host should also check for this condition.

After the (multi)word/byte write has been suspended, the host can write the Read Array command to read data from any location except the suspended location. The only other valid commands while (multi)word/byte write is suspended are Read Status Register and (Multi)Word/Byte Write Resume. After the host writes a (Multi)Word/Byte Write Resume to the CUI, the WSM will continue the (multi)word/byte write process. Status register bits SR.2 and SR.7 will automatically clear and BUSY# will return to  $V_{OL}$ . After the host writes the (Multi)Word/Byte Write Resume command, the device automatically outputs status register data when read.

## 8.12 Status Register

The memory devices in this card have Status Register which shows state of the device.

Byte Access × 8 Bits

| bit7  | bit6  | bit5   | bit4   | bit3  | bit2  | bit1  | bit0  |
|-------|-------|--------|--------|-------|-------|-------|-------|
| SR. 7 | SR. 6 | SR. 5  | SR. 4  | SR. 3 | SR. 2 | SR. 1 | SR. 0 |
| WSMS  | BESS  | ECBLBS | WSBLBS | VPPS  | WSS   | DPS   | R     |

Table 10. Status Register Definition

|  |  |
|--|--|
| <p><b>SR. 7 = WRITE STATE MACHINE STATUS</b><br/>           1 = Ready<br/>           0 = Busy</p> <p><b>SR. 6 = BLOCK ERASE SUSPEND STATUS</b><br/>           1 = Block Erase Suspended<br/>           0 = Block Erase in Progress/Completed</p> <p><b>SR. 5 = ERASE AND CLEAR BLOCK LOCK-BITS STATUS</b><br/>           1 = Error in Erase or Clear Block Lock-Bits<br/>           0 = Successful Erase or Clear Block Lock-Bits</p> <p><b>SR. 4 = WRITE AND SET BLOCK-BIT STATUS</b><br/>           1 = Error in Write or Set Block Lock-Bit<br/>           0 = Successful Write or Set Block Lock-Bit</p> <p><b>SR. 3 = V<sub>PP</sub> STATUS</b><br/>           1 = V<sub>PP</sub> Low Detect, Operation Abort<br/>           0 = V<sub>PP</sub> OK</p> <p><b>SR. 2 = WRITE SUSPEND STATUS</b><br/>           1 = Write Suspended<br/>           0 = Write in Progress/Completed</p> <p><b>SR. 1 = DEVICE PROTECT STATUS</b><br/>           1 = Block Lock-Bit and/or WP# Lock Detected, Operation Abort<br/>           0 = Unlock</p> | <p><b>SR. 0 = RESERVED FOR FUTURE ENHANCEMENTS NOTES:</b><br/>           Check SR.7 to determine block erase, full chip erase, (multi) word/byte write or block lock-bit configuration completion. SR.6-0 are invalid while SR.7 = "0".<br/>           If both SR.5 and SR.4 are "1"s after a block erase, full chip erase, (multi) word/byte write, block lock-bit configuration or STS configuration attempt, an improper command sequence was entered.<br/>           SR.3 does not provide a continuous indication of V<sub>PP</sub> level. The WSM interrogates and indicates the V<sub>PP</sub> level only after block erase, full chip erase, (multi) word/byte write or block lock-bit configuration command sequences. SR.3 is not guaranteed to reports accurate feedback only when V<sub>PP</sub> 5V± 5%<br/>           SR.1 does not provide a continuous indication of block lock-bit values. The WSM interrogates the block lock-bit, and WP# only after Block Erase, full chip erase, (multi) Word/Byte Write, or Block Lock-Bit configuration command sequences. It informs the system, depending on the attempted operation, if the block lock-bit is set and/or WP# is not V<sub>IH</sub>. Reading the block lock configuration codes after writing the Read Identifier Codes command indicates block lock-bit status.<br/>           SR.0 is reserved for future use and should be masked out when polling the status register.</p> |
|--|--|

Table 11. Extended Status Register Definition

|        |        |        |        |        |        |        |        |
|--------|--------|--------|--------|--------|--------|--------|--------|
| XSR. 7 | XSR. 6 | XSR. 5 | XSR. 4 | XSR. 3 | XSR. 2 | XSR. 1 | XSR. 0 |
| SMS    | R      | R      | R      | R      | R      | R      | R      |
| 7      | 6      | 5      | 4      | 3      | 2      | 1      | 0      |

|   |   |
|---|---|
| <p>XSR.7 = STATE MACHINE STATUS</p> <p>1 = Multi Word/Byte Write available</p> <p>2 = Multi Word/Byte Write not available</p> <p>XSR.6-0 = RESERVED FOR FUTURE ENHANCEMENTS</p> | <p>NOTES:</p> <p>After issue a Multi Word/Byte Write command: XSR.7 indicates that a next Multi Word/Byte Write command is available.</p> <p>XSR.6-0 is reserved for future use and should be masked out when polling the extended status register.</p> |
|---|---|

Word Access × 16 Bits

|                  |        |        |        |        |        |       |       |                 |       |       |       |       |       |       |       |
|------------------|--------|--------|--------|--------|--------|-------|-------|-----------------|-------|-------|-------|-------|-------|-------|-------|
| bit15            |        |        |        |        |        |       |       | bit8            |       | bit7  |       | bit0  |       |       |       |
| SR.15            | SR.14  | SR.13  | SR.12  | SR.11  | SR.10  | SR.9  | SR.8  | SR.7            | SR.6  | SR.5  | SR.4  | SR.3  | SR.2  | SR.1  | SR.0  |
| XSR.15           | XSR.14 | XSR.13 | XSR.12 | XSR.11 | XSR.10 | XSR.9 | XSR.8 | XSR.7           | XSR.6 | XSR.5 | XSR.4 | XSR.3 | XSR.2 | XSR.1 | XSR.0 |
| High Byte device |        |        |        |        |        |       |       | Low Byte device |       |       |       |       |       |       |       |



## 8.13 Automated Word/Byte Write Flowchart

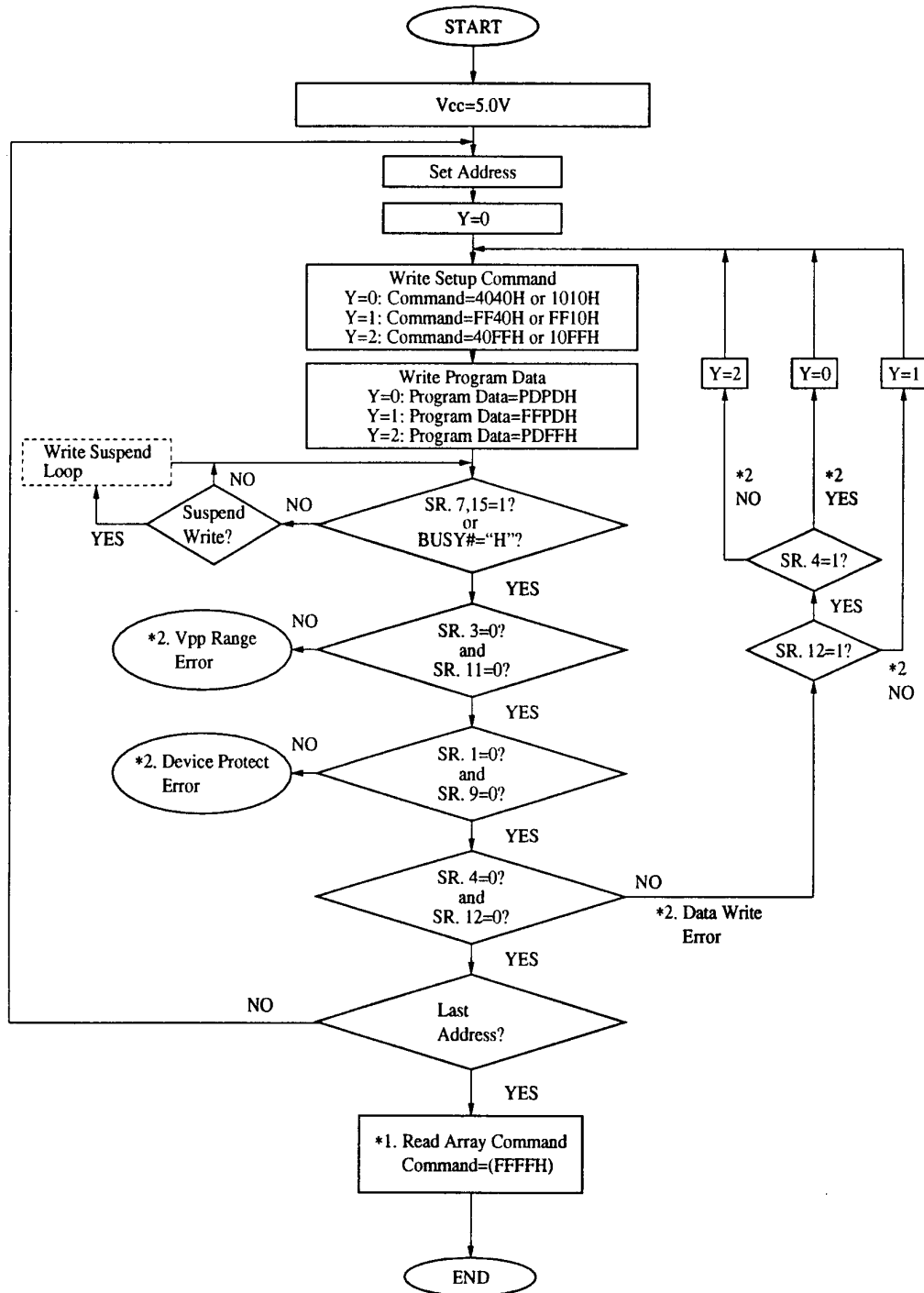

Note) \*1. Write FFFFH after the last word write operation to reset the device to Read Array Mode.

\*2. If error is detected, clear the Status Register before attempting retry or other error recovery.

## 8.14 Multi Word/Byte Write Flowchart

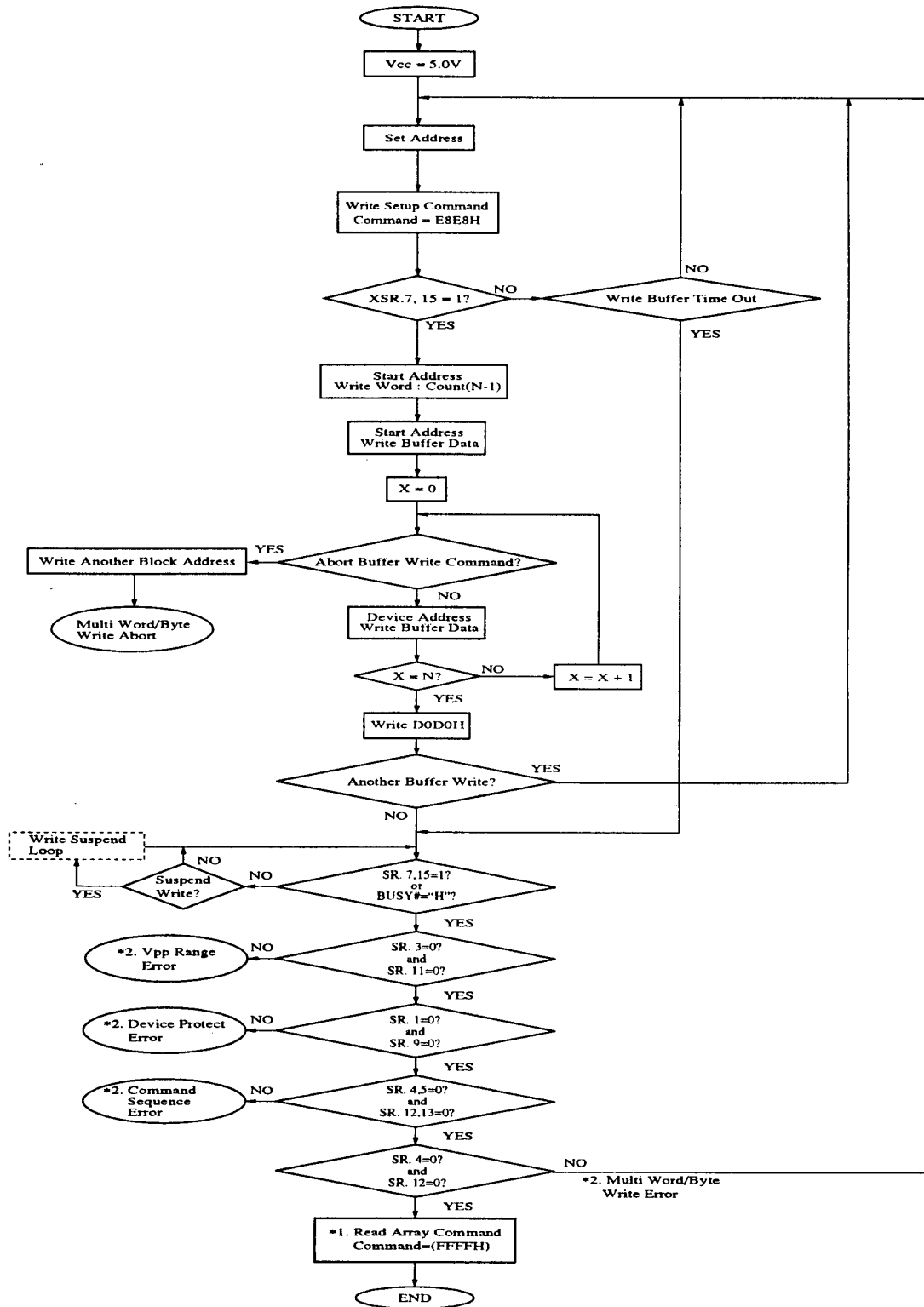

Note) \*1. Write FFH after the last word write operation to reset the device to Read Array Mode.

\*2. If error is detected, clear the Status Register before attempting retry or other error recovery.

## 8.15 Automated Block Erase Flowchart

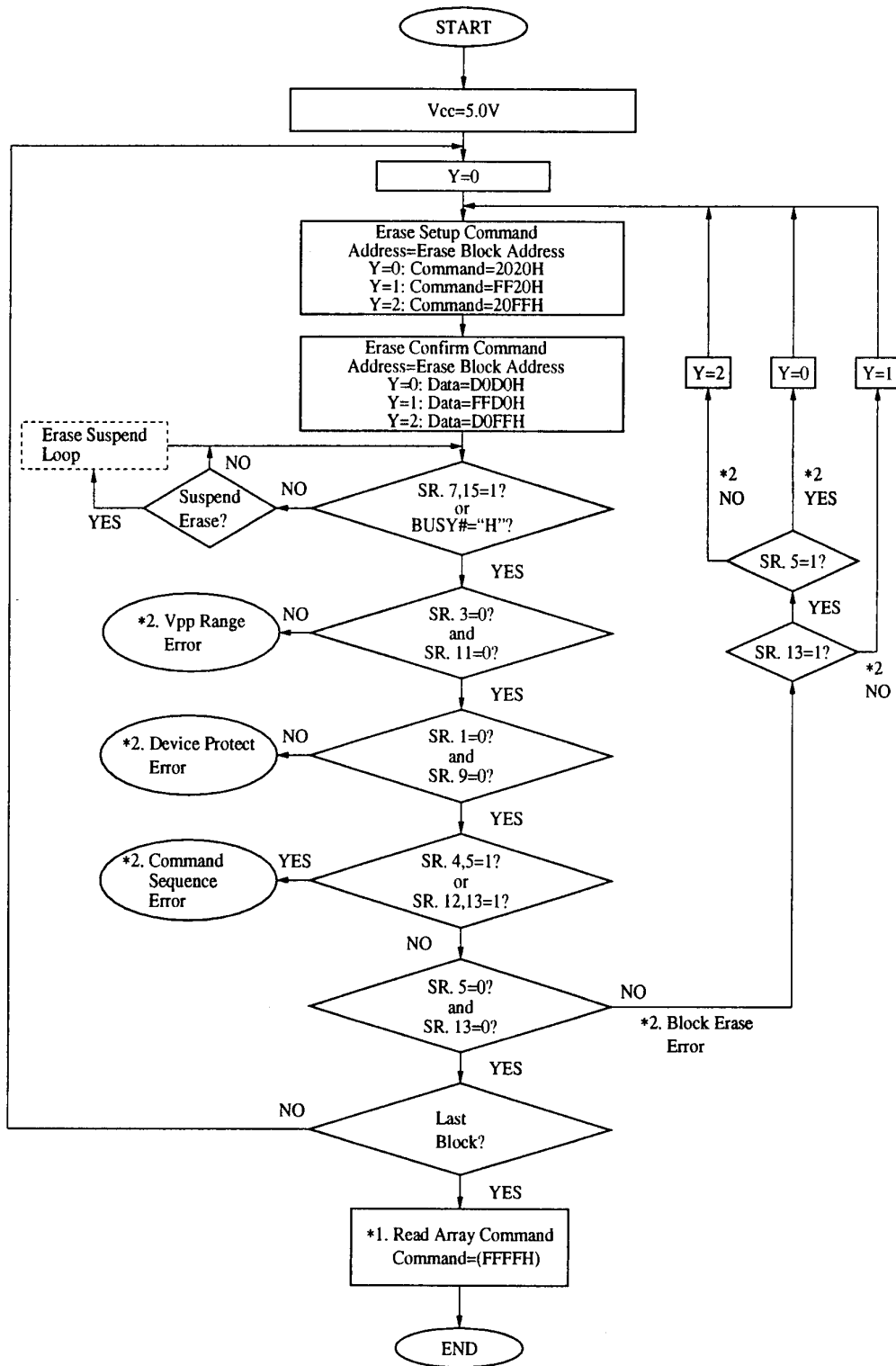

(Note)\*1. Write FFFFH after the last block erase operation to reset the device to Read Array Mode.

\*2. If error is detected, clear the Status Register before attempting retry or other error recovery.

## 8.16 Automated Full Chip Erase Flowchart

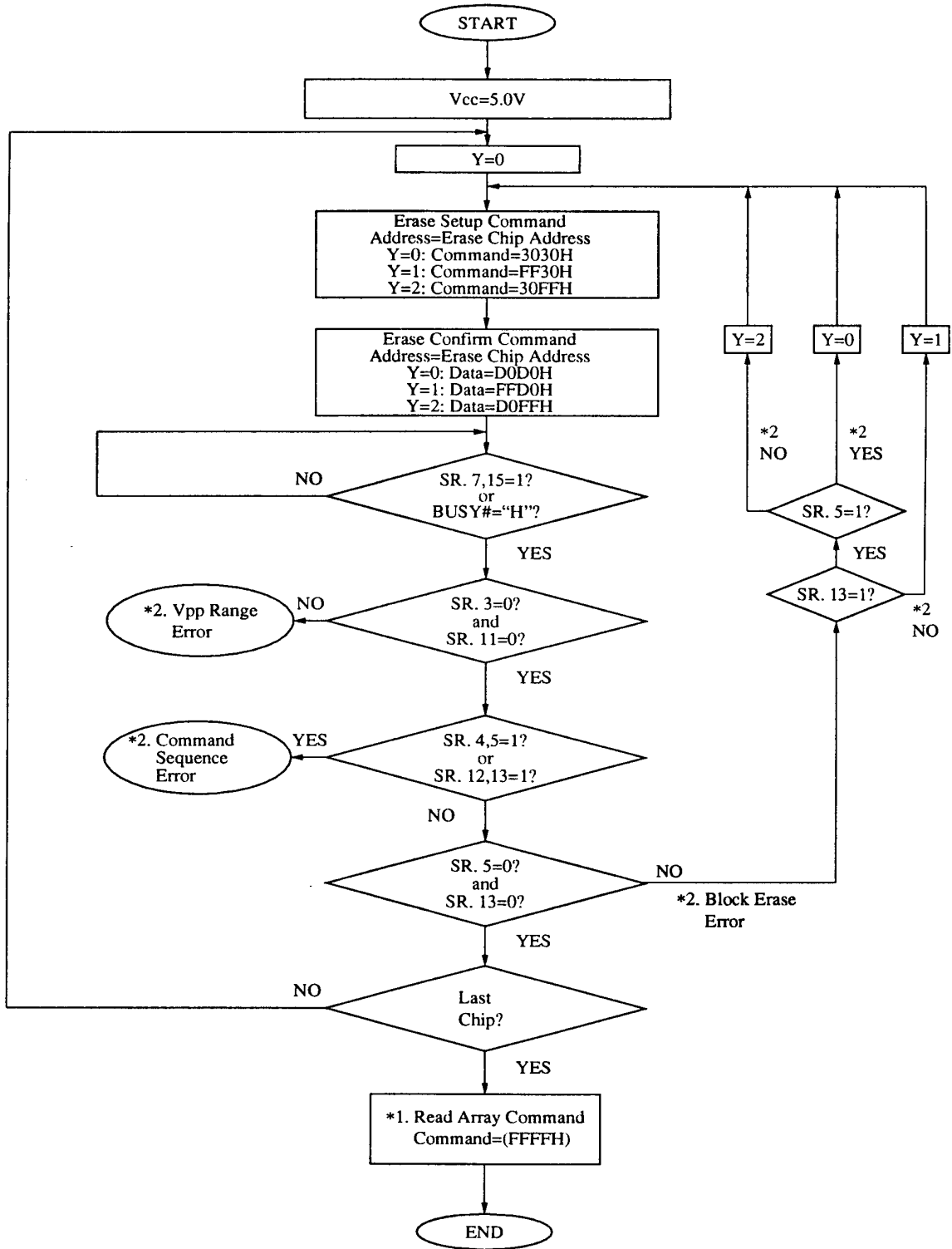

Note) \*1. Write FFH after the last block erase operation to reset the device to Read Array Mode.

\*2. If error is detected, clear the Status Register before attempting retry or other error recovery.

## 9. Electrical Specifications

### 9.1 Absolute Maximum Ratings

| PARAMETER                                   | SYMBOL           | RATING                                   | UNIT |
|---|------------------|--|------|
| Supply Voltage <sup>(2)</sup>               | V <sub>CC</sub>  | -0.2 to 7.0                              | V    |
| Input Voltage <sup>(2)</sup>                | V <sub>IN</sub>  | -0.5 to V <sub>CC</sub> + 0.5 (Max: 7.0) | V    |
| Output Short Circuit Current <sup>(3)</sup> | I <sub>OUT</sub> | 100                                      | mA   |
| Operating Temperature <sup>(1)</sup>        | T <sub>OPR</sub> | 0 to 60                                  | °C   |
| Storage Temperature                         | T <sub>STG</sub> | -30 to 70                                | °C   |

#### NOTES:

1. Operating temperature is for commercial product defined by this specification.
2. All specified voltages are with respect to GND.
3. Output shorted for no more than one second. No more than one output shorted at a time.

### 9.2 Recommended Operating Conditions

| PARAMETER             | SYMBOL           | MINIMUM | MAXMUM | UNIT |
|-----------------------|------------------|---------|--------|------|
| Operating Temperature | T <sub>OPR</sub> | 0       | 60     | °C   |
| Supply Voltage        | V <sub>CC</sub>  | 4.75    | 5.25   | V    |

### 9.3 Capacitance

T<sub>a</sub> = 25°C, f = 1MHz

| PARAMETER                | SYMBOL          | MIN | TYP | MAX | UNIT | CONDITION               |
|--------------------------|-----------------|-----|-----|-----|------|-------------------------|
| Input Capacitance        | C <sub>IN</sub> | —   | 28  | 40  | pF   | V <sub>IN</sub> = 0.0V  |
| Input/Output Capacitance | C <sub>IO</sub> | —   | 18  | 24  | pF   | V <sub>OUT</sub> = 0.0V |

### 9.4 AC Input/Output Test Conditions

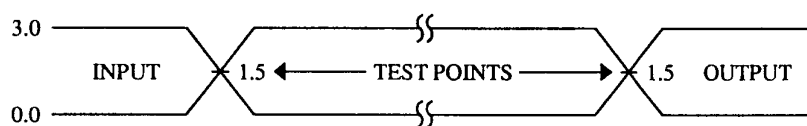

Figure 4. Transient Input/Output Reference Waveform for V<sub>CC</sub> = 5.0V ± 5%  
(Standard Testing Configuration)

AC test inputs are driven at 3.0V for a Logic "1" and 0.0V for a Logic "0". Input timing begins, and output timing ends, at 1.5V. Input rise and fall times (10% to 90%) < 10ns.

## 10. DC Characteristics

(Ta = 0~60°C)

| PARAMETER   | SYMBOL                                 | NOTES         | V <sub>CC</sub> = 5.0V |     | UNIT | TEST CONDITIONS   |
|---|--|---------------|------------------------|-----|------|---|
|   |  |               | MIN                    | MAX |      |   |
| Input Leakage Current (A0–A21)                            | I <sub>LI1</sub>                       | 1             | —                      | ±5  | μ A  | V <sub>CC</sub> = V <sub>CC</sub> Max,<br>V <sub>IN</sub> = V <sub>CC</sub> or GND                                    |
| Input Leakage Current (A22)                               | I <sub>LI2</sub>                       | 1             | -2                     | 58  | μ A  | V <sub>CC</sub> = V <sub>CC</sub> Max,<br>V <sub>IN</sub> = V <sub>CC</sub> or GND                                    |
| Input Leakage Current (CEL#,CEH#,RESET#)                  | I <sub>LI3</sub>                       | 1             | -57                    | 1   | μ A  | V <sub>CC</sub> = V <sub>CC</sub> Max,<br>V <sub>IN</sub> = V <sub>CC</sub> or GND                                    |
| Input Leakage Current (OE#,WE#)                           | I <sub>LI4</sub>                       | 1             | -60                    | 4   | μ A  | V <sub>CC</sub> = V <sub>CC</sub> Max,<br>V <sub>IN</sub> = V <sub>CC</sub> or GND                                    |
| Output Leakage Current (D0–D15)                           | I <sub>LO</sub>                        | 1             | —                      | ±20 | μ A  | V <sub>CC</sub> = V <sub>CC</sub> Max,<br>V <sub>IN</sub> = V <sub>CC</sub> or GND                                    |
| V <sub>CC</sub> Standby Current                           | I <sub>CCS</sub>                       | 1, 3          | —                      | 550 | μ A  | V <sub>CC</sub> = V <sub>CC</sub> Max,<br>CEL#,CEH# = V <sub>CC</sub> ± 0.2V,<br>RESET# = V <sub>CC</sub> ± 0.2V      |
| V <sub>CC</sub> Deep Power-Down Current                   | I <sub>CCD</sub>                       | 1, 3          | —                      | 190 | μ A  | RESET# = GND ± 0.2V,<br>I <sub>OUT</sub> (BUSY#)=0 mA   |
| V <sub>CC</sub> Read Current                              | I <sub>CCR</sub>                       | 1, 3,<br>4, 5 | —                      | 126 | mA   | V <sub>CC</sub> = V <sub>CC</sub> Max, CEL#,CEH#=<br>GND±0.2V, t <sub>cycle</sub> = 100ns,<br>I <sub>OUT</sub> = 0 mA |
| V <sub>CC</sub> Word Write Current                        | I <sub>CCW</sub>                       | 1, 5          | —                      | 236 | mA   |   |
| V <sub>CC</sub> Block Erase Current                       | I <sub>CCB</sub>                       | 1, 5          | —                      | 146 | mA   |   |
| V <sub>CC</sub> Word Write or Block Erase Suspend Current | I <sub>CCWS</sub><br>I <sub>CCES</sub> | 1, 2, 5       | —                      | 26  | mA   | CEL# = CEH# = V <sub>IH</sub>   |

| PARAMETER                       | SYMBOL           | NOTES | V <sub>CC</sub> = 5.0V |                      | UNIT | TEST CONDITIONS   |
|---------------------------------|------------------|-------|------------------------|----------------------|------|---|
|                                 |                  |       | MIN                    | MAX                  |      |   |
| Input Low Voltage               | V <sub>IL</sub>  | —     | -0.5                   | 0.8                  | V    |   |
| Input High Voltage              | V <sub>IH</sub>  | —     | 0.7 V <sub>CC</sub>    | V <sub>CC</sub> +0.5 | V    |   |
| Output Low Voltage              | V <sub>OL</sub>  | —     | —                      | 0.1V <sub>CC</sub>   | V    | V <sub>CC</sub> = V <sub>CC</sub> Min,<br>I <sub>OL</sub> = 5.8mA |
| Output High Voltage             | V <sub>OH</sub>  | —     | 0.9V <sub>CC</sub>     | —                    | V    | V <sub>CC</sub> = V <sub>CC</sub> Min<br>I <sub>OH</sub> = -100μA |
| V <sub>CC</sub> Lockout Voltage | V <sub>LKO</sub> | —     | 2.0                    | —                    | V    |   |

## NOTES:

- All currents are in RMS unless otherwise noted.
- I<sub>CCWS</sub> and I<sub>CCES</sub> are specified with the device de-selected. If read or byte written while in erase suspend mode, the device's current draw is the sum of I<sub>CCWS</sub> or I<sub>CCES</sub> and I<sub>CCR</sub> or I<sub>CCW</sub>, respectively.
- CMOS inputs are either V<sub>CC</sub> ± 0.2V or GND ± 0.2V.
- Automatic Power Savings (APS) reduces typical I<sub>CCR</sub> to 1mA at 5V V<sub>CC</sub> in static operation (addresses not switching).
- All values are based on word accesses. Values for byte accesses are 50% of the specification listed.

## 11. AC Characteristics (Ta = 0~60°C)

Testing Conditions :

- 1) Input Pulse Level : 0.0V~3.0V
- 2) Input Rise/Fall Time : 10ns
- 3) Input/Output Timing Reference Level : 1.5V
- 4) Output Load : 30pF (including scope and jig capacitance)

### 11.1 Read Operations

(Ta = 0 ~ 60°C)

| PARAMETER                           | SYMBOL             | V <sub>CC</sub> = 5.0V |     | UNIT |     |
|-------------------------------------|--------------------|------------------------|-----|------|-----|
|                                     |                    | IEEE                   | MIN |      | MAX |
| Read Cycle Time                     | t <sub>AVAV</sub>  |                        | 100 | —    | ns  |
| Address Access Time                 | t <sub>AVQV</sub>  |                        | —   | 100  |     |
| Card Enable Access Time             | t <sub>ELQV</sub>  |                        | —   | 100  |     |
| Output Enable Access Time           | t <sub>GLQV</sub>  |                        | —   | 40   |     |
| Output Disable Time from CEL#/CEH#* | t <sub>EHQZ</sub>  |                        | —   | 10   |     |
| Output Disable Time from OE#*       | t <sub>GHQZ</sub>  |                        | —   | 10   |     |
| Output Enable Time from CEL#/CEH#   | t <sub>ELQNZ</sub> |                        | 5   | —    |     |
| Output Enable Time from OE#         | t <sub>GLQNZ</sub> |                        | 5   | —    |     |
| Data Hold from Address              | t <sub>AXQX</sub>  |                        | 0   | —    |     |
| Data Hold from CEL#/CEH#            | t <sub>EHQX</sub>  |                        | 0   | —    |     |
| Data Hold from OE#                  | t <sub>GHQX</sub>  |                        | 0   | —    |     |
| CE# Setup Time to OE# Active        | t <sub>ELGL</sub>  |                        | 0   | —    |     |
| Address Setup Time to OE# Active    | t <sub>AVGL</sub>  |                        | 0   | —    |     |
| Power-Down Recovery to Output Delay | t <sub>PHQV</sub>  |                        | —   | 400  |     |

\* Time until output becomes floating. (The output voltage is not defined.)

### 11.2 AC Waveforms for Read Operations

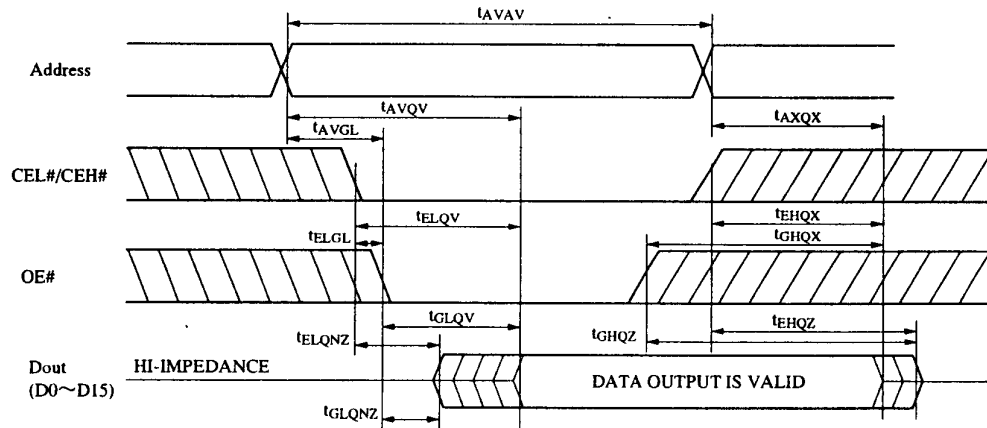

- Note) 1. WE# = "HIGH", during a read cycle.  
 2. Either "HIGH" or "LOW" in diagonal areas.  
 3. The output data becomes valid when last interval, t<sub>AXQV</sub>, t<sub>ELQV</sub> or t<sub>GLQV</sub> have concluded.

## 11.3 Write Operations

### 11.3.1 WE# Controlled Write Operations

(Ta = 0~60°C)

| PARAMETER                            | SYMBOL            | V <sub>CC</sub> = 5.0V |     | UNIT |
|--------------------------------------|-------------------|------------------------|-----|------|
|                                      | IEEE              | MIN                    | MAX |      |
| Write Cycle Time                     | t <sub>AVAV</sub> | 100                    | —   | ns   |
| Address Setup Time                   | t <sub>AVWL</sub> | 10                     | —   |      |
| Write Recovery Time                  | t <sub>WHAX</sub> | 5                      | —   |      |
| Data Setup Time for WE#              | t <sub>DVWH</sub> | 40                     | —   |      |
| Data Hold Time                       | t <sub>WHDX</sub> | 15                     | —   |      |
| Output Enable Hold from WE#          | t <sub>WHGL</sub> | 10                     | —   |      |
| Card Enable Setup time for WE#       | t <sub>ELWH</sub> | 70                     | —   |      |
| Address Setup for WE#                | t <sub>AVWH</sub> | 70                     | —   |      |
| Write Pulse Width                    | t <sub>WLWH</sub> | 60                     | —   |      |
| WE# High to RDY/BSY# Going Low       | t <sub>WHRL</sub> | —                      | 150 |      |
| Power-Down Recovery to WE# Going Low | t <sub>PHWL</sub> | 1                      | —   | μs   |

### 11.3.2 CE# Controlled Write Operations

(Ta = 0~60°C)

| PARAMETER                            | SYMBOL            | V <sub>CC</sub> = 5.0V |     | UNIT |
|--------------------------------------|-------------------|------------------------|-----|------|
|                                      | IEEE              | MIN                    | MAX |      |
| Write Cycle Time                     | t <sub>AVAV</sub> | 10                     | —   | ns   |
| Address Setup Time                   | t <sub>AVEL</sub> | 10                     | —   |      |
| Write Recovery Time                  | t <sub>EHAX</sub> | 5                      | —   |      |
| Data Setup Time for CE#              | t <sub>DVEH</sub> | 15                     | —   |      |
| Data Hold Time                       | t <sub>EHDX</sub> | 15                     | —   |      |
| Output Enable Hold from CE#          | t <sub>EHGL</sub> | 10                     | —   |      |
| Write Enable Setup time for CE#      | t <sub>WLEH</sub> | 70                     | —   |      |
| Address Setup for CE#                | t <sub>AVEH</sub> | 70                     | —   |      |
| Card Enable Pulse Width              | t <sub>ELEH</sub> | 60                     | —   |      |
| CE# High to RDY/BSY# Going Low       | t <sub>EHRL</sub> | —                      | 150 |      |
| Power-Down Recovery to CE# Going Low | t <sub>PEHL</sub> | 1                      | —   | μs   |







### 11.4 Erase and Data Write Performance<sup>(3)</sup>

(Ta = 0~60°C)

| PARAMETER                  | SYMBOL             | NOTES | V <sub>CC</sub> = 5.0V |                    |      | UNIT |
|----------------------------|--------------------|-------|------------------------|--------------------|------|------|
|                            |                    |       | MIN                    | TYP <sup>(1)</sup> | MAX  |      |
| Byte Write Time            | t <sub>WHQV1</sub> | 2     | —                      | 9.24               | TBD  | μs   |
|                            | t <sub>EHQV1</sub> |       |                        |                    |      |      |
| Block Write Time           |                    | 2     | —                      | 0.61               | 7.5  | s    |
| Multi Word/Byte Write Time |                    |       | —                      | 2                  | TBD  | μs   |
| Block Erase Time           | t <sub>WHQV2</sub> | 2     | —                      | 0.34               | 10   | s    |
|                            | t <sub>EHQV2</sub> |       |                        |                    |      |      |
| Full Chip Erase Time       |                    |       | —                      | 21.8               | TBD  | s    |
| Byte Write Suspend Latency | t <sub>WHRH1</sub> | —     | —                      | 5.6                | 7    | μs   |
| Time to Read               | t <sub>EHRH1</sub> |       |                        |                    |      |      |
| Erase Suspend Latency      | t <sub>WHRH2</sub> | —     | —                      | 9.4                | 13.1 | μs   |
| Time to Read               | t <sub>EHRH2</sub> |       |                        |                    |      |      |

#### NOTES:

1. Typical values measured at Ta = 25°C and nominal voltages. Assumes corresponding lock-bits are not set. Subject to change based on device characterization.
2. Excludes system-level overhead.
3. Sampled but not 100% tested.

## 11.5 Power-Up

| PARAMETER                   | SYMBOL                       | NOTES | MIN | MAX | UNITS |
|-----------------------------|------------------------------|-------|-----|-----|-------|
| CE# Setup Time              | $t_{su}(\text{CEL\#/CEH\#})$ | —     | 1   | —   | ms    |
| RESET# Setup Time           | $t_{su}(\text{RESET\#})$     | —     | 1   | —   | ms    |
| V <sub>CC</sub> Rising Time | $t_{pr}$                     | 1     | 0.1 | 100 | ms    |
| RESET# Width                | $t_w(\text{RESET\#})$        | —     | 1   | —   | μs    |

**NOTES:**

- The  $t_{pr}$  is defined as “linear waveform” in the period of 10% to 90%. Even if the waveform is not a “linear waveform,” its rising time must meet this specification.

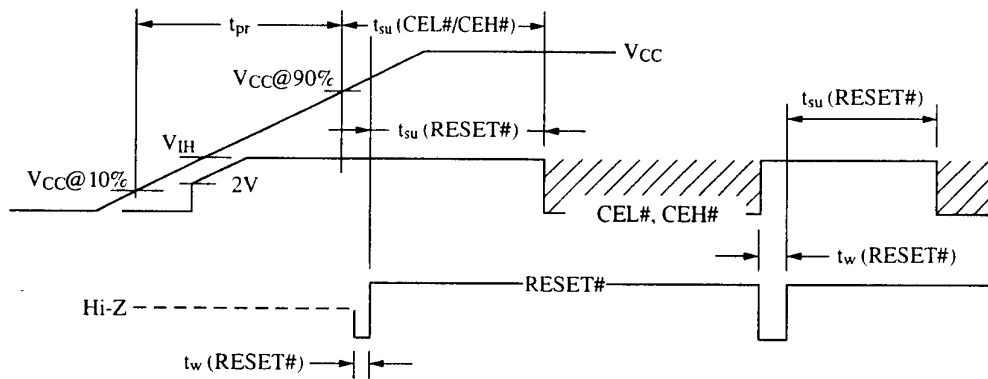

Power-Up Timing for Systems Supporting RESET#

## 12. Specification Changes

Specifications may be changed upon discussion and agreement between both parties.

## 13. Other Precautions

- Permanent damage occurs if the Miniature card is stressed beyond Absolute Maximum Ratings. Operation beyond the Recommended Operating Conditions is not recommended and extended exposure beyond the Recommended Operating Conditions may affect device reliability.
- Writing to the Miniature card can be prevented by switching on the write protect switch on the side of the Miniature card.
- Avoid allowing the Miniature card Pads to come in contact with metals and avoid touching the Pads, as the internal circuits can be damaged by static electricity.
- Avoid storing in direct sunlight, high temperatures (do not place near heaters or radiators), high humidity and dusty areas.
- Avoid subjecting the Miniature card to strong physical abuse. Dropping, bending, smashing or throwing the card can result in loss of function.
- When the Miniature card is not being used, return it to its protective case.
- Do not allow the Miniature card to come in contact with fire.

Topside

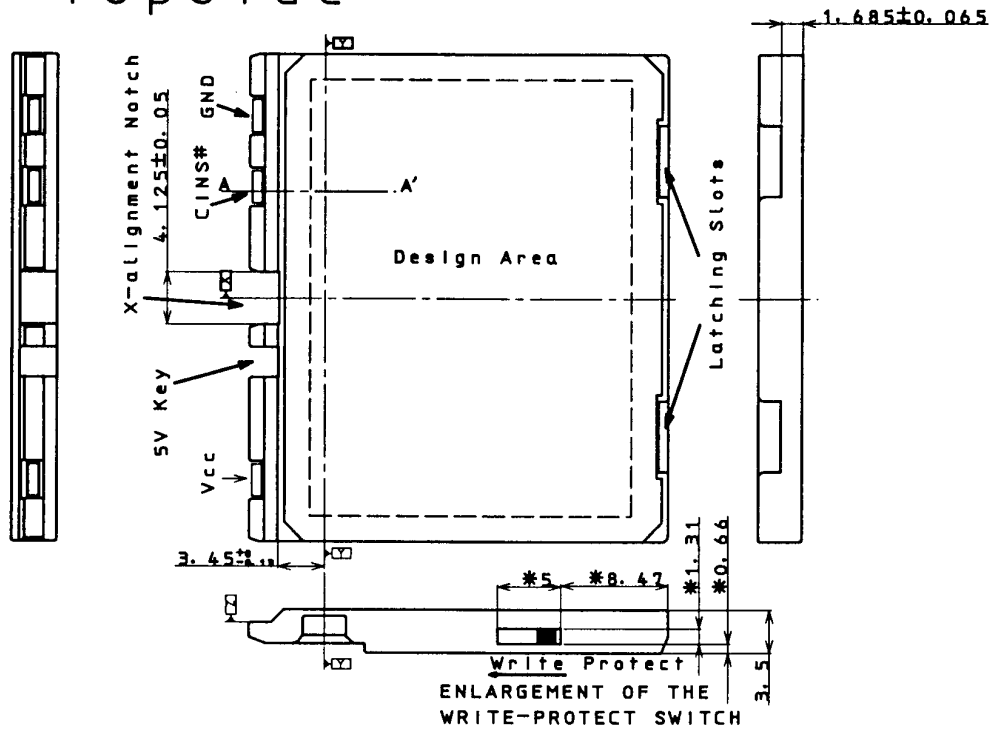

Bottomside

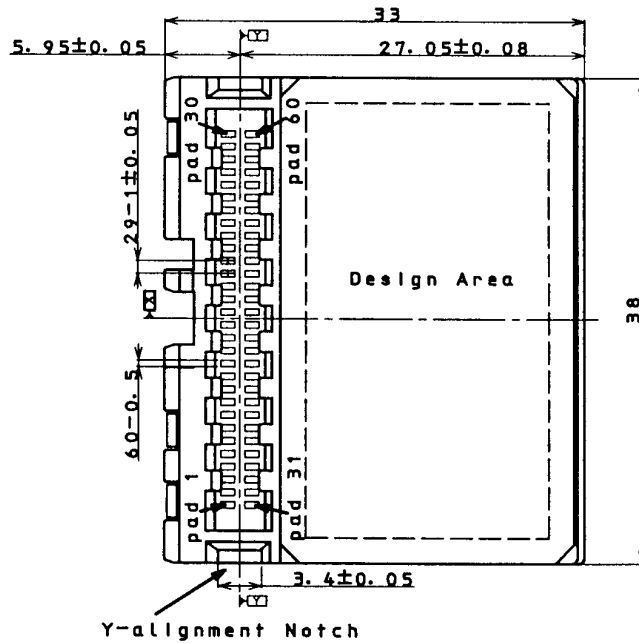

SECTION A-A'

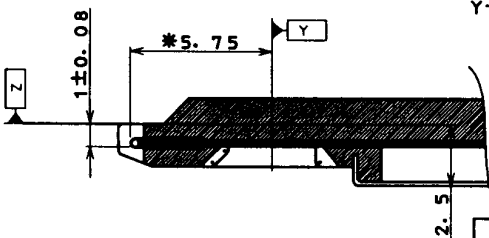

|              |   |          |                                  |             |   |
|--------------|---|----------|----------------------------------|-------------|---|
| APPLICABLE   |   | SCALE    | UNIT                             |             |   |
|              |   |          | mm                               |             |   |
| THICKNESS    | TOLERANCES                              | MATERIAL | FINISH                           | CH. DATE    | REVISE  |
|              | DECIMALS<br>-XX =±0.13<br>*XX.XX =±0.25 |          |                                  | NAME        | Miniature Card<br>External Dimensions<br>5.0Voltage-key |
| DATE         | 1998. 10. 28                            |          |                                  |             | Miniature Card<br>Release 1. 1                          |
| DESIGN/ DRAW | CHECK                                   | APPROVE  | IMAGE DEVICE ENGINEERING DEPT. 2 |             |   |
|              |   |          | INTEGRATED CIRCUITS GROUP        |             |   |
|              |   |          | SHARP CORPORATION                |             |   |
|              |   |          |                                  | DRAWING NO. | IMC219-A100   |



15. Packing Specification

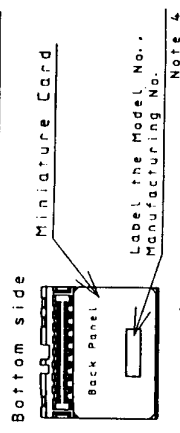

Parts List

| Parts Name                            |
|---------------------------------------|
| A Flexible Plastic Bag                |
| B Inner Carton (100 pieces contained) |
| C Outer Carton (500 pieces contained) |
| D Outer Case (1000 pieces contained)  |
|                                       |
|                                       |
|                                       |
|                                       |

Packing Specification

1. Label on which the Model No. and Manufacturing No. are printed is attached on the back panel of the card.
2. Each Miniature Card is contained in the Flexible plastic bag. (The terminals of the card are attached to the opposite side of the place where the card is released from the opposite side of the place are not touched by finger, as shown in the figure.)
3. The inner carton contains 100 pieces of the card. (Note 1.)
4. The product name, lot no. (product no.), quantity and the date are either written directly on the inner carton or printed on the label which is attached on inner carton.
5. The outer carton contains 5 inner cartons. (Note 2.)
6. The product name, lot no. (product no.), quantity and the date are either written directly on the outer carton or printed on the label which is attached on the outer carton.
7. The outer carton is put into the outer case, which contains 2 outer cartons. (Note 3.)
8. The product name, lot no. (product no.), quantity and the date are either written directly on the case or printed on the label which is attached on the case.

1. The least packing unit is 100 pieces, which is contained in the inner carton.
2. The inner space of the outer carton is filled with card beads.
3. Other size of outer case may be used if there is not enough quantity to fill the normal outer case which can contain 2 outer cartons.
4. The size and descriptions of the label on the back panel of the card are follows. [unit:mm]

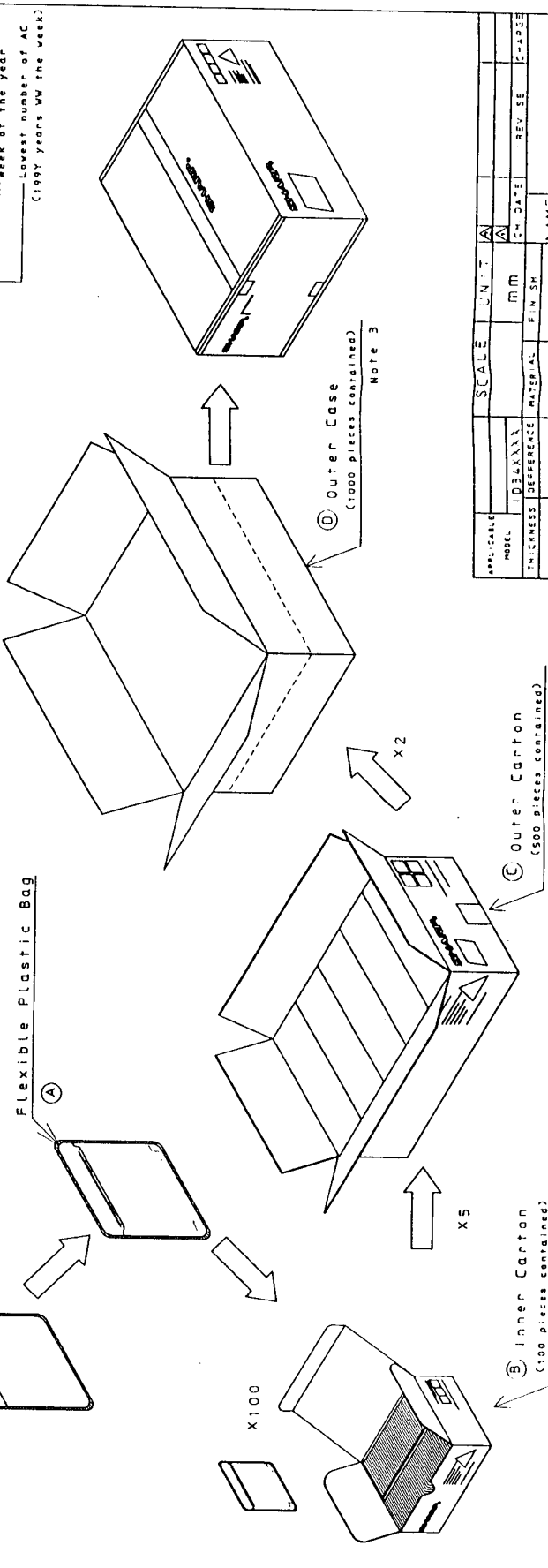
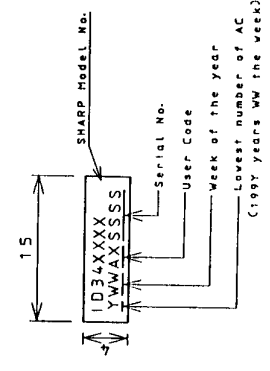

|                         |              |          |                       |        |
|-------------------------|--------------|----------|-----------------------|--------|
| APPLICABLE MODEL        | ID34XXX      | SCALE    | UNIT                  | IN     |
| THICKNESS               | DIFFERENCE   | MATERIAL | FINISH                | MM     |
| DATE                    | 1997.10.30   | DATE     | REV. SE               | CHANGE |
| DESIGNED                | Y. KAWAKATSU | NAME     | Packing Specification |        |
| DRAWN                   | Y. KAWAKATSU | DATE     | 1997.10.30            |        |
| CHECKED                 | Y. KAWAKATSU | DESIGNED | Y. KAWAKATSU          |        |
| APPROVED                | Y. KAWAKATSU | DESIGNED | Y. KAWAKATSU          |        |
| SHARP CORPORATION       |              |          |                       |        |
| DRAWING NO. IMC2-9-J1CC |              |          |                       |        |

Flash, 16 MB, Non-Volatile Memory, Miniature Card, PCMCIA Card, ID343K01