

Absolute Maximum Ratings (Ta=25°C)

Absolute maximum ratings indicate sustained limits beyond which damage to the device may occur. All voltage parameters are absolute voltages referenced to terminals stated, all currents are defined positive into any lead. The thermal resistance and power dissipation ratings are measured under board mounted and still air conditions.

| Symbol | Definition | Terminals | Max. Ratings | Units | Note |
|--------|---|-----------|--------------|--------|---|
| IDpeak | Drain Current *1 | 1-2 | 12 | A | Single Pulse |
| IDMAX | Maximum switching current *5 | 1-2 | 12 | A | V ₂₋₃ =0.78V Ta=-20~+125°C |
| EAS | Single pulse avalanche energy *2 | 1-2 | 157 | mJ | Single Pulse VDD=99V, L=20mH IL peak=3.5A |
| Vin | Input voltage for control part | 4-3 | 35 | V | |
| Vth | O.C.P/F.B Pin voltage | 5-3 | 6 | V | |
| PD1 | Power dissipation for MOSFET *3 | 1-2 | 24 1.5 | W W | With infinite heatsink Without heatsink |
| PD2 | Power dissipation for control part (Control IC) *4 | 4-3 | 0.8 | W | Specified by Vin × Iin |
| TF | Internal frame temperature in operation | - | -20 ~ +125 | °C | Refer to recommended operating temperature |
| Top | Operating ambient temperature | - | -20 ~ +125 | °C | |
| Tstg | Storage temperature | - | -40 ~ +125 | °C | |
| Tch | Channel temperature | - | 150 | °C | |

*1 Refer to MOS FET A.S.O curve

*2 MOS FET Tch-EAS curve

*3 Refer to MOS FET Ta-PD1 curve

*4 Refer to TF-PD2 curve for Control IC (See page 5)

*5 Maximum switching current.

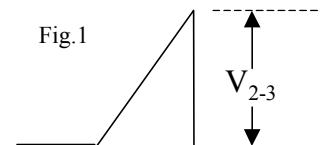

The maximum switching current is the Drain current determined by the drive voltage of the IC and threshold voltage (Vth) of MOS FET. Therefore, in the event that voltage drop occurs between Pin 2 and Pin 3 due to patterning, the maximum switching current decreases as shown by V₂₋₃ in Fig.1 Accordingly please use this device within the decrease value, referring to the derating curve of the maximum switching current.

Electrical Characteristics (for Control IC)

Electrical characteristics for control part (Ta=25°C, Vin=18V, unless otherwise specified)

| Symbol | Definition | Ratings | | | Units | Test Conditions |
|-------------------------|---|---------|------|------|-------|----------------------------|
| | | MIN | TYP | MAX | | |
| V _{in(ON)} | Operation start voltage | 14.4 | 16 | 17.6 | V | V _{in} =0→17.6V |
| V _{in(OFF)} | Operation stop voltage | 9 | 10 | 11 | V | V _{in} =17.6→9V |
| I _{m(ON)} | Circuit current in operation | - | - | 30 | mA | - |
| I _{m(OFF)} | Circuit current in non-operation | - | - | 100 | μA | V _{in} =14V |
| T _{OFF(MAX)} | Maximum OFF time | 45 | - | 55 | μsec | - |
| T _{th(2)} | Minimum time for input of quasi resonant signals *6 | - | - | 1 | μsec | - |
| T _{OFF(MIN)} | Minimum OFF time *7 | - | - | 1.5 | μsec | - |
| V _{th(1)} | O.C.P/F.B Pin threshold voltage 1 | 0.68 | 0.73 | 0.78 | V | - |
| V _{th(2)} | O.C.P/F.B Pin threshold voltage 2 | 1.3 | 1.45 | 1.6 | V | - |
| I _{OCP/FB} | O.C.P/F.B Pin extraction current | 1.2 | 1.35 | 1.5 | mA | - |
| V _{in(OVP)} | O.V.P operation voltage | 20.5 | 22.5 | 24.5 | V | V _{in} =0→24.5V |
| I _{in(H)} | Latch circuit sustaining current *8 | - | - | 400 | μA | V _{in} =24.5→8.5V |
| V _{in(La.OFF)} | Latch circuit release voltage *8 | 6.6 | - | 8.4 | V | V _{in} =24.5→6.6V |
| T _{j(TSD)} | Thermal shutdown operating temperature | 140 | - | - | °C | - |

*6 Recommended operating conditions

Time for input of quasi resonant signals
For the quasi resonant signal inputted to OCP/FB Pin at the time of quasi resonant operation, the signal shall be wider than T_{th(2)}.

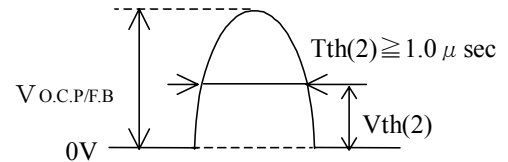

*7 The minimum OFF time means T_{OFF} width at the time when the minimum quasi resonant signal is inputted.

*8 The latch circuit means a circuit operated O.V.P and T.S.D.

Electrical Characteristics (for MOSFET)

(Ta=25°C) unless otherwise specified

| Symbol | Definition | Ratings | | | Units | Test Conditions |
|---------------------|-----------------------------------|---------|-----|-----|-------|---|
| | | MIN | TYP | MAX | | |
| V _{DSS} | Drain-to-Source breakdown voltage | 450 | - | - | V | ID=300μA V3-2=0V(short) |
| I _{DSS} | Drain leakage current | - | - | 300 | μA | V _D S=450V V3-2=0V(short) |
| R _{DS(ON)} | On-resistance | - | - | 1.3 | Ω | V3-2=10V ID=1.5A |
| t _f | Switching time | - | - | 250 | nsec | - |
| θ _{ch-F} | Thermal resistance | - | - | 2.3 | °C/W | Between channel and internal frame |

IRIS-G6623

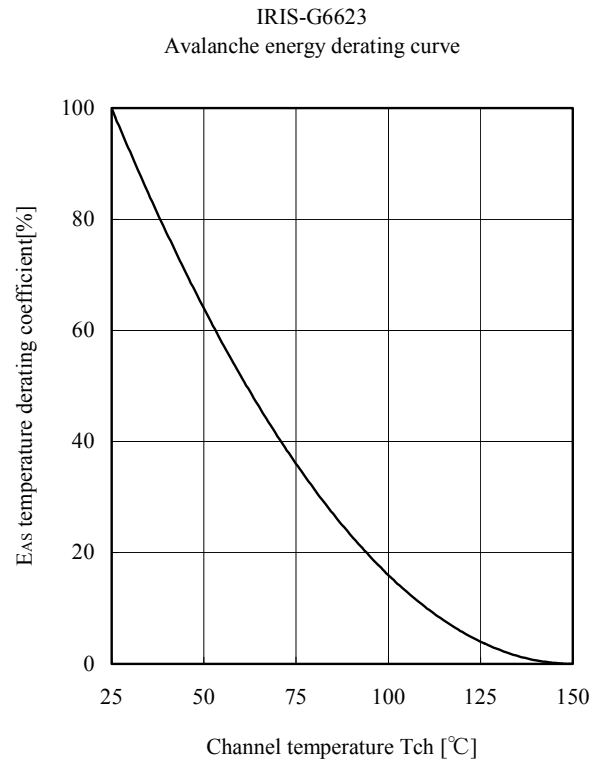
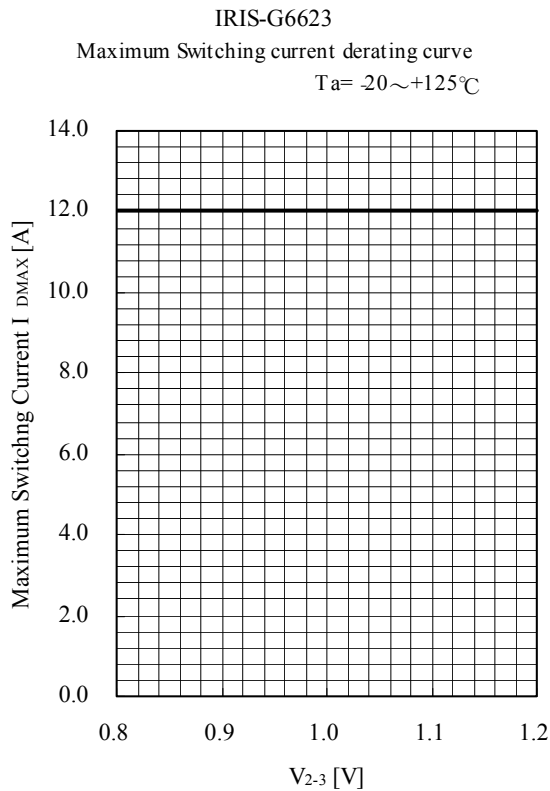
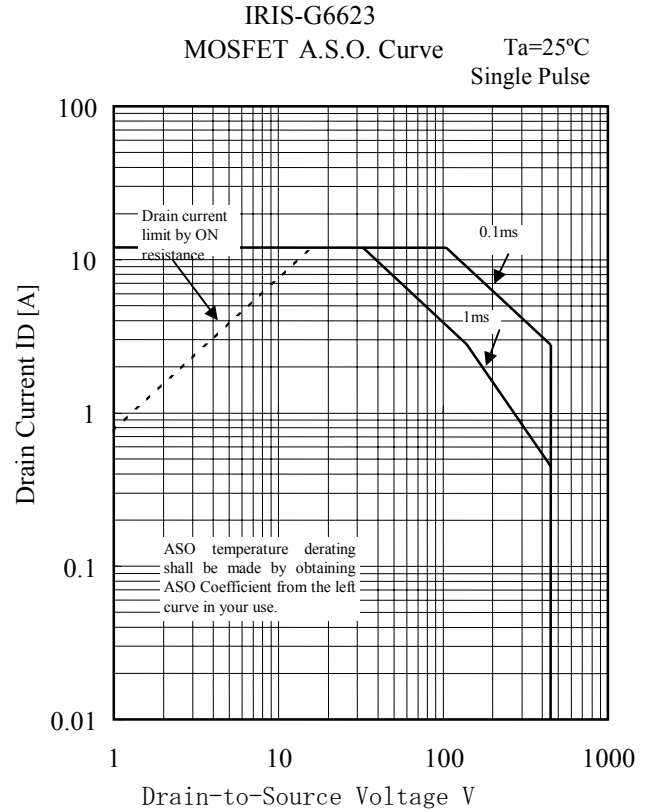
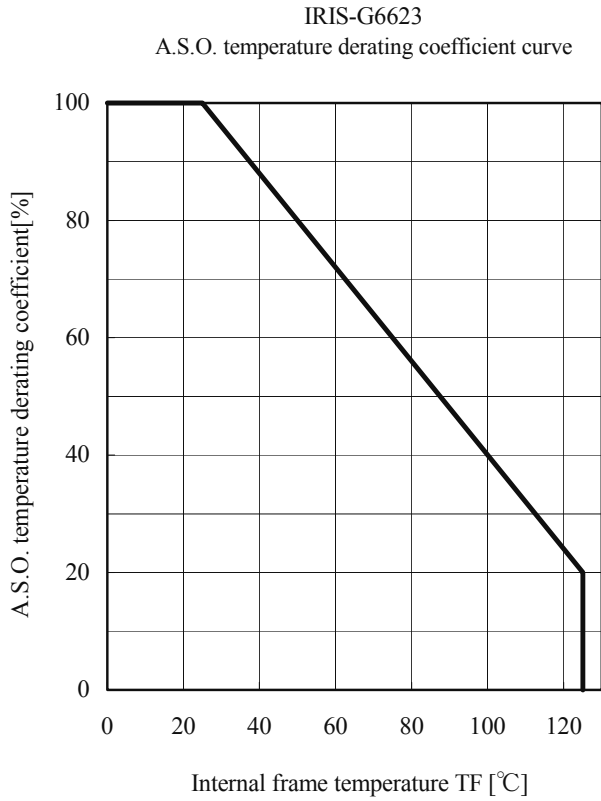

IRIS-G6623
MOSFET Ta-P_{D1} Curve

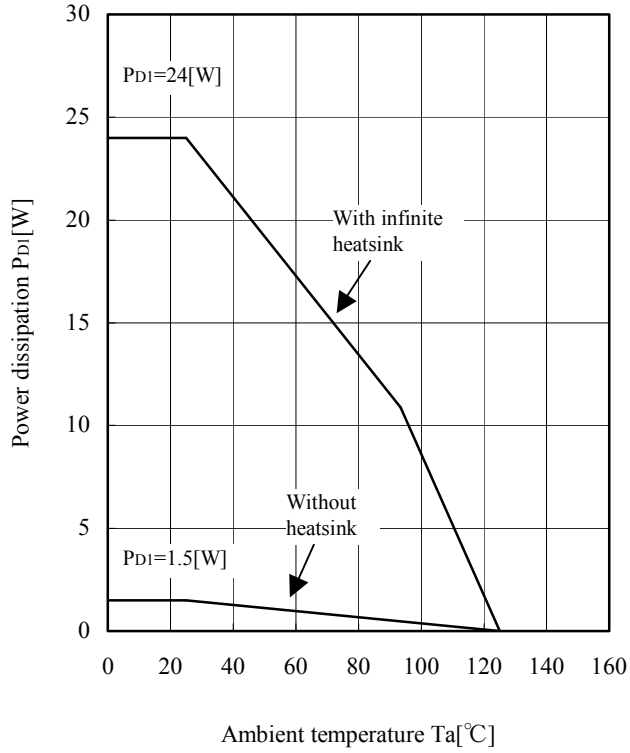

IRIS-G6623
MIC TF-PD2 Curve

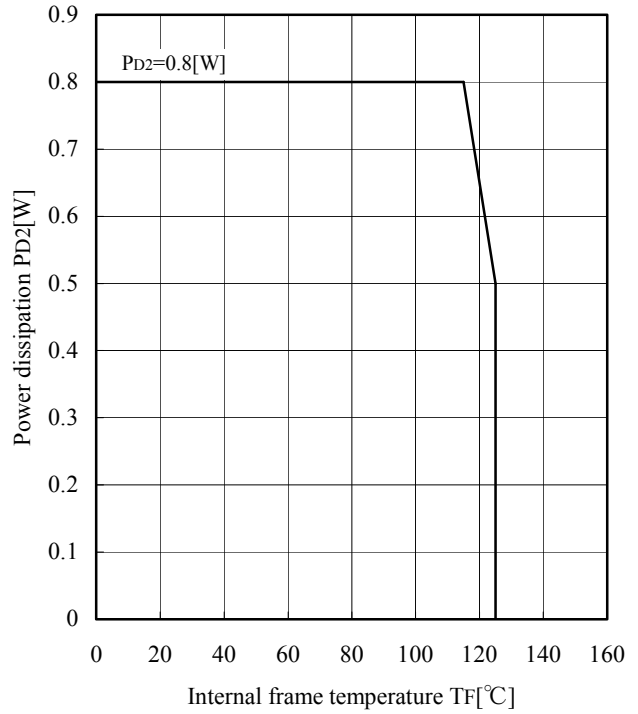

IRIS-G6623
Transient thermal resistance curve

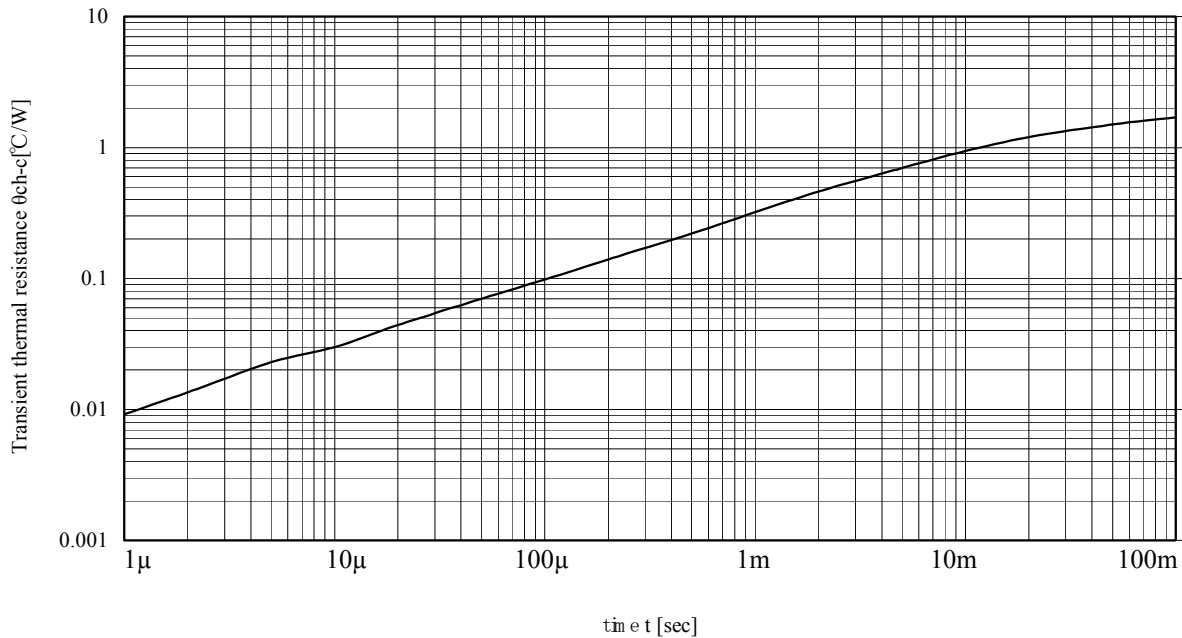

Block Diagram

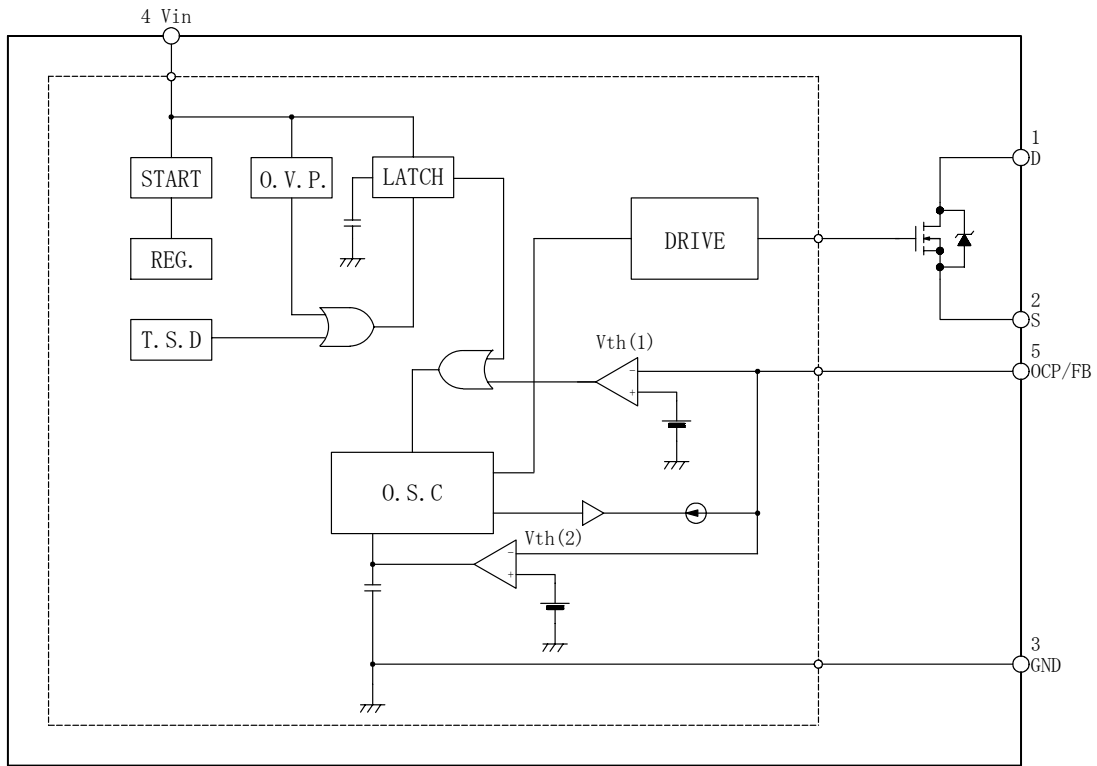

Lead Assignments

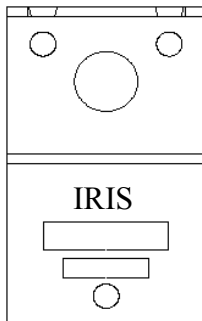

| Pin No. | Symbol | Description | Function |
|---------|--------|----------------------------|---|
| 1 | D | Drain Pin | MOSFET drain |
| 2 | S | Source Pin | MOSFET source |
| 3 | GND | Ground Pin | Ground |
| 4 | Vin | Power supply Pin | Input of power supply for control circuit |
| 5 | OCP/FB | Overcurrent / Feedback Pin | Input of overcurrent detection signal / constant voltage control signal |

Other Functions

O.V.P. – Overvoltage Protection Circuit

T.S.D. – Thermal Shutdown Circuit

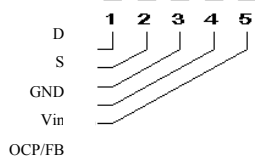

Case Outline

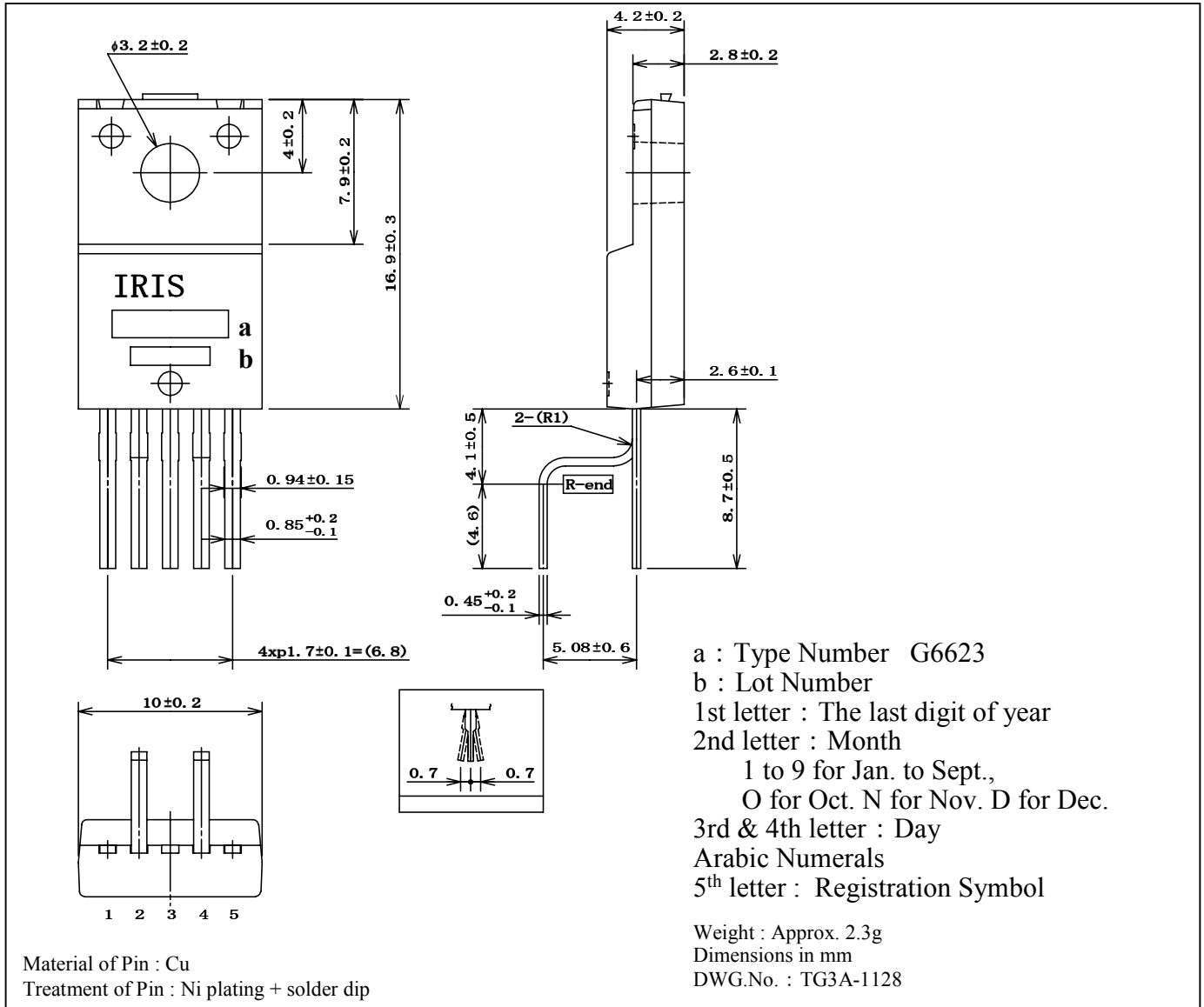

Data and specifications subject to change without notice.