

### LC503PPG1-30Q-A

#### Features

5mm Package  
 High Optical Power  
 High Luminous Intensity  
 Water Clear Lens  
 All Plastic Mold Type  
 PRELIMINARY SPEC

#### Applications

Outdoor Message Centers  
 VMS  
 Automotive Interior Lighting  
 Traffic Signals  
 Pedestrian Signals  
 Decorative Lighting



### ATTENTION

OBSERVE PRECAUTIONS  
 ELECTROSTATIC  
 SENSITIVE DEVICES

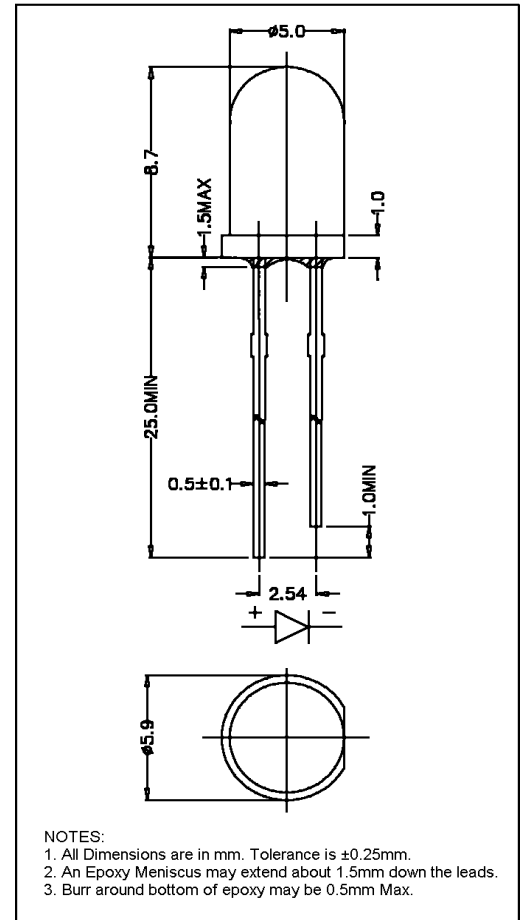

#### Maximum Ratings ( $T_a=25^\circ\text{C}$ )

Characteristic	Symbol	Max.	Unit
Forward Current	$I_F$	25	mA
Reverse Voltage	$V_R$	5	V
Power Dissipation	$P_D$	105.00	mW
Operating Temperature	$T_{opr}$	-40 ~ +95	$^\circ\text{C}$
Storage Temperature	$T_{stg}$	-40 ~ +100	$^\circ\text{C}$
Soldering Temperature	$T_{sol}$	260	$^\circ\text{C}$
Soldering Time	-	for 3 sec. max	-

#### Opto-Electrical Characteristics ( $T_a=25^\circ\text{C}$ )

Characteristic	Symbol	Test Condition	Min	Typ	Max	Unit
Forward Voltage	$V_F$	$I_F=20\text{mA}$	--	3.60	4.20	V
Reverse Current	$I_R$	$V_R=5\text{V}$	-	-	100	$\mu\text{A}$
Luminous Intensity	$I_v$	$I_F=20\text{mA}$	3000.00	4800.00	-	mcd
Viewing Angle	$2\theta^{1/2}$	-	-	$30^\circ$	-	deg.
Peak Wavelength	$\lambda_p$	$I_F=20\text{mA}$	-	520	-	nm
Dominant Wavelength	$\lambda_d$	$I_F=20\text{mA}$	-	525	-	nm
Spectral Line Half Width	$\Delta\lambda$	$I_F=20\text{mA}$	-	38	-	nm

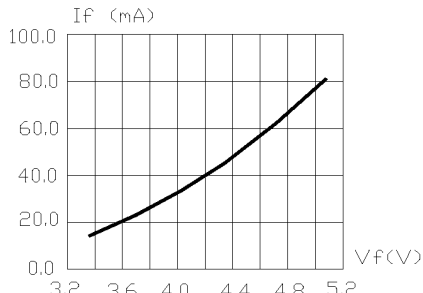

FIG.1 FORWARD CURRENT VS. FORWARD VOLTAGE.

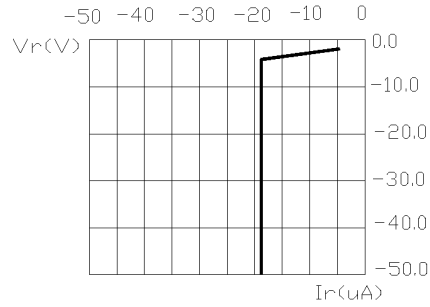

FIG.2 REVERSE CURRENT VS. REVERSE VOLTAGE.

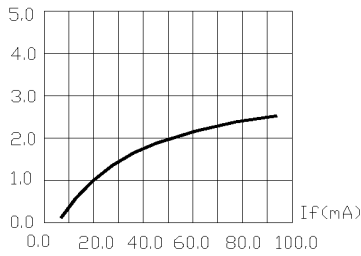

FIG.3 RELATIVE LUMINOUS INTENSITY VS. FORWARD CURRENT.

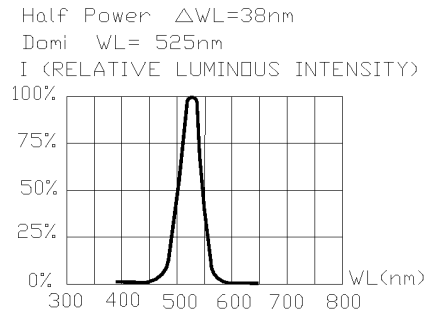

FIG.4 RELATIVE LUMINOUS INTENSITY VS. WAVELENGTH.

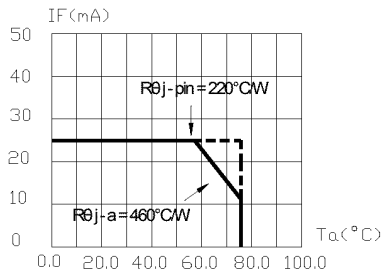

FIG.5 MAXIMUM FORWARD DC CURRENT VS AMBIENT TEMPERATURE ( $T_{jmax} = 95^{\circ}C$ )

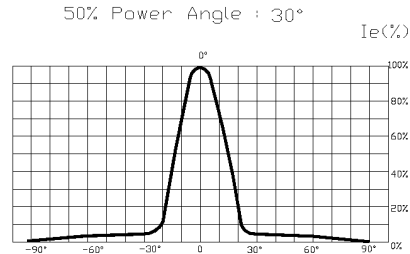

FIG.6 FAR FIELD PATTERN

1. Cathode PAD Area (0.18 × 0.18inch<sup>2</sup>)
2. Height above nominal seating plane in inches(0.3inch)