

2012 Size

1400/1600 MHz

Chip Multilayer Splitter/Combiner

FSLH-S150C

All the technical data and information contained herein are subject to change without notice.



LH-FSLH-S150C-0406A

Equivalent Circuits

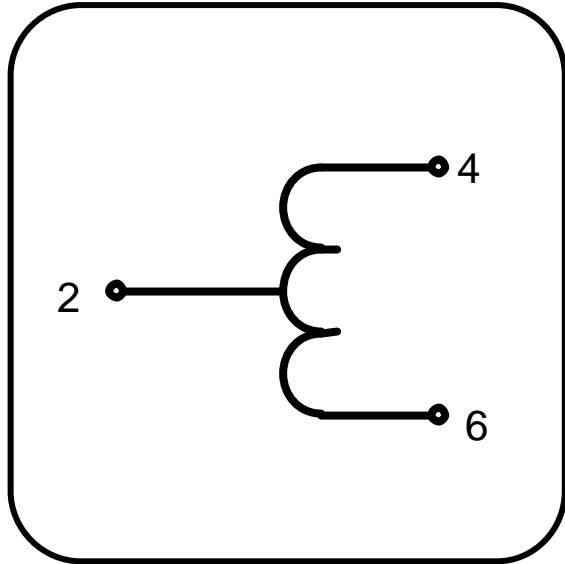

Shape & Size

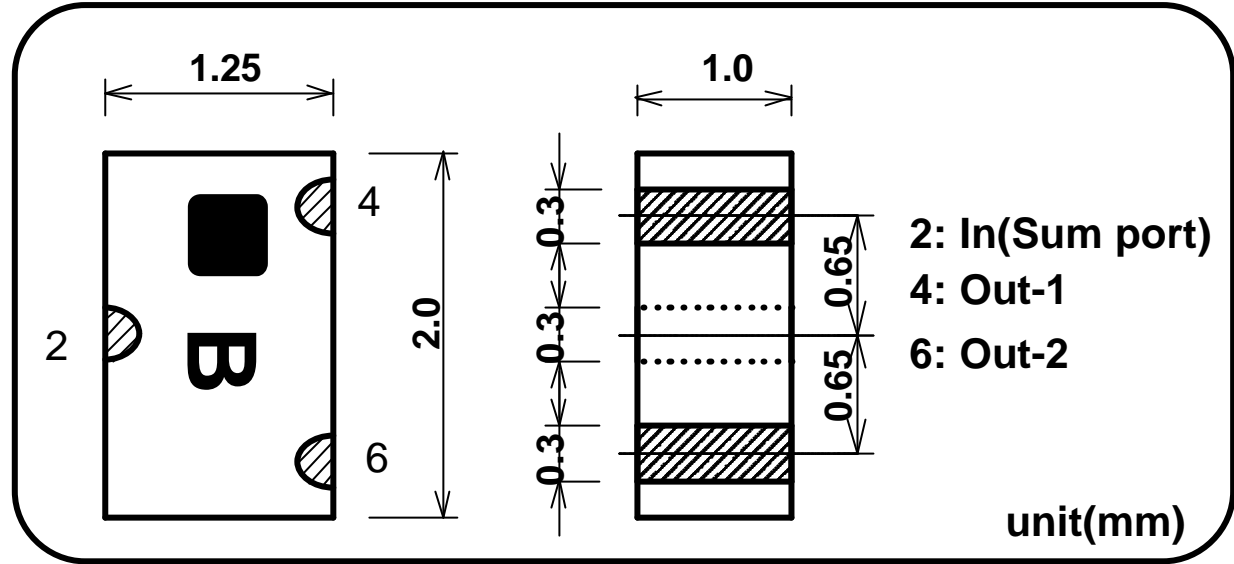

Specifications

Part Name: FSLH-S150C

Frequency Range	Matching Capacitor	Insertion Loss *1	Isolation	Return Loss	Handling Power	Temperature Range
1400-1600MHz	1.5pF	1dB Max. (0.20dB Typ.)	12dB Min. (30dB Typ.)	10dB Min. (20dB Typ.)	1W Max. (CW)	-35 to +85 deg.C

*1 Not include splitting loss (3dB)

All the technical data and information contained herein are subject to change without notice.

LH-FSLH-S150C-0406A

FOOT PATTERN

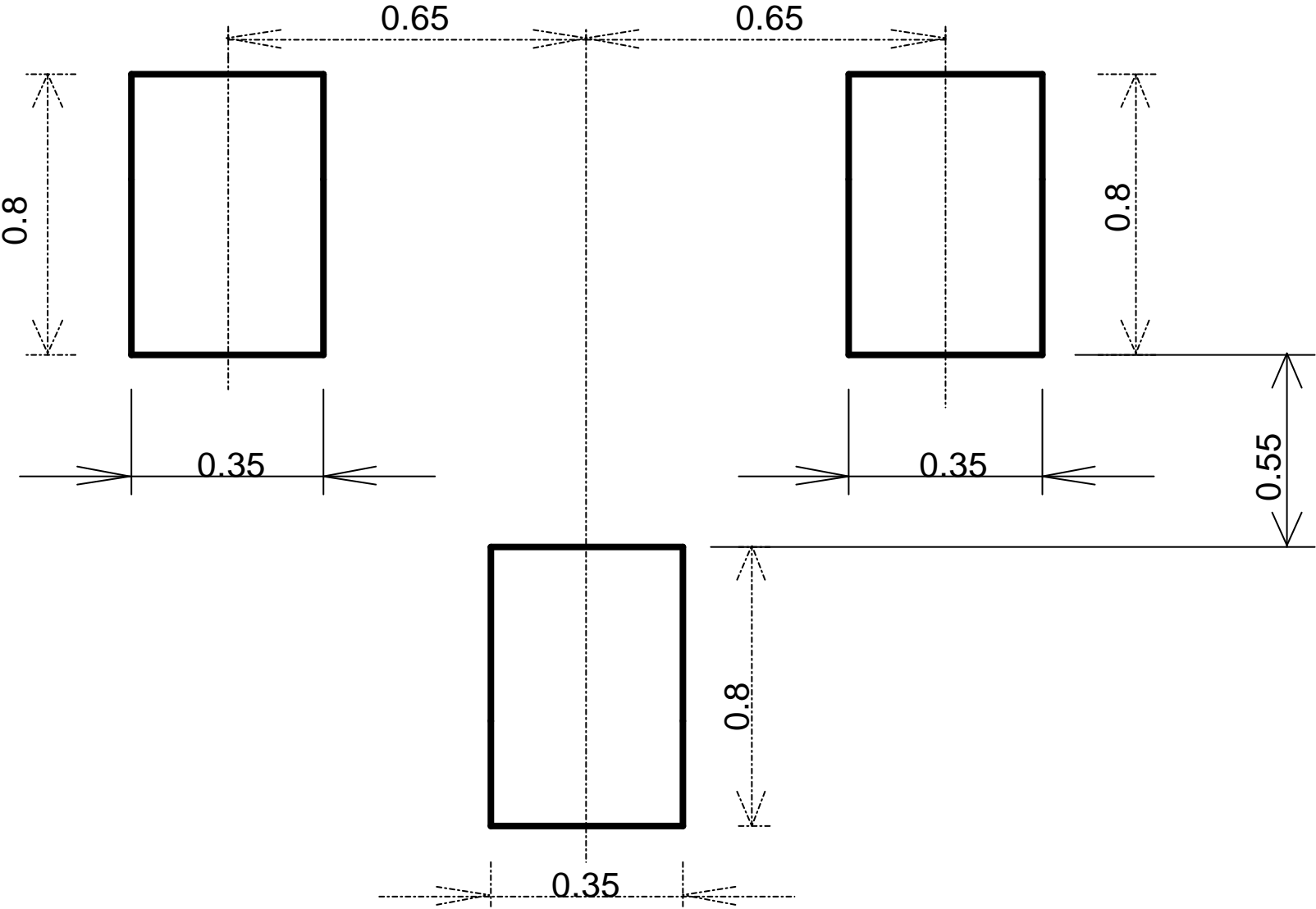

All the technical data and information contained herein are subject to change without notice.

LH-FSLH-S150C-0406A

FSLH-S150C Sample Data

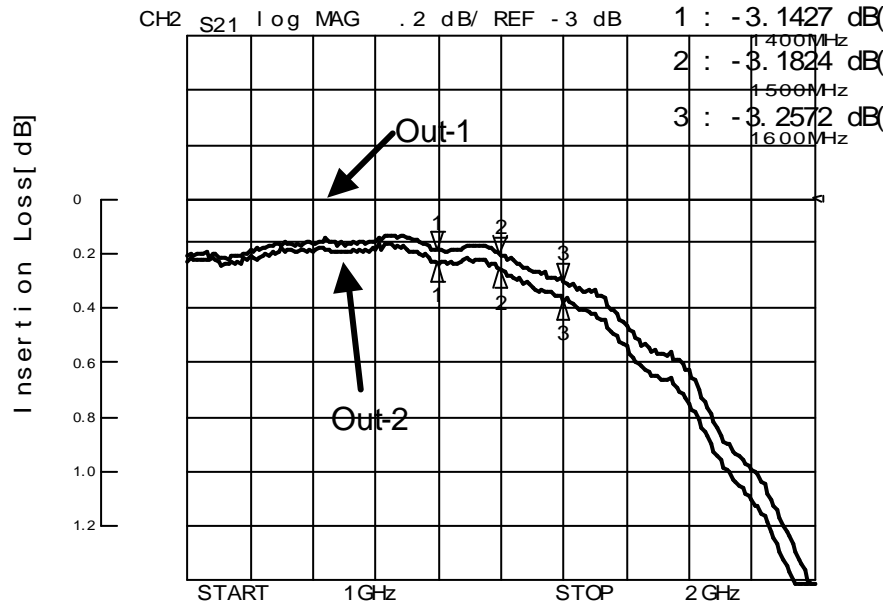
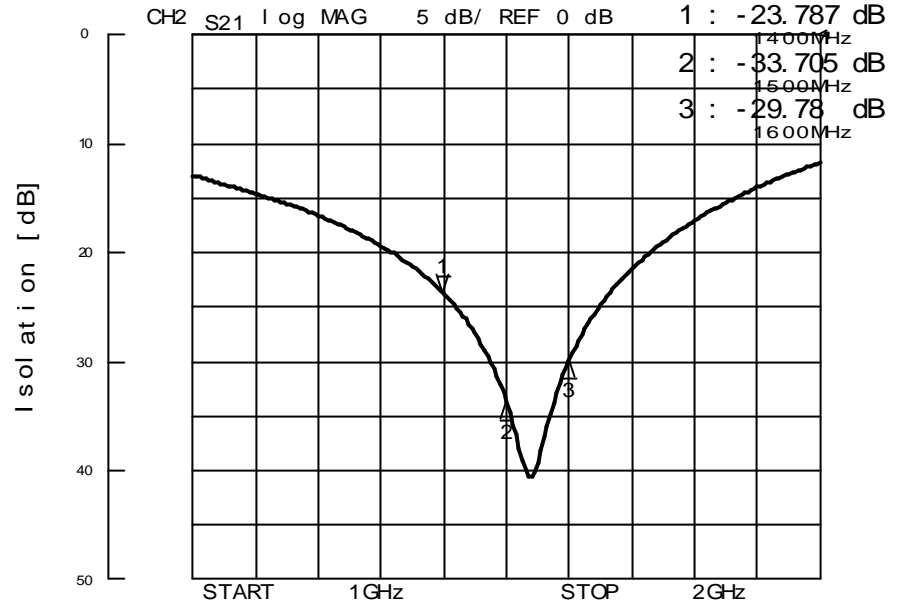
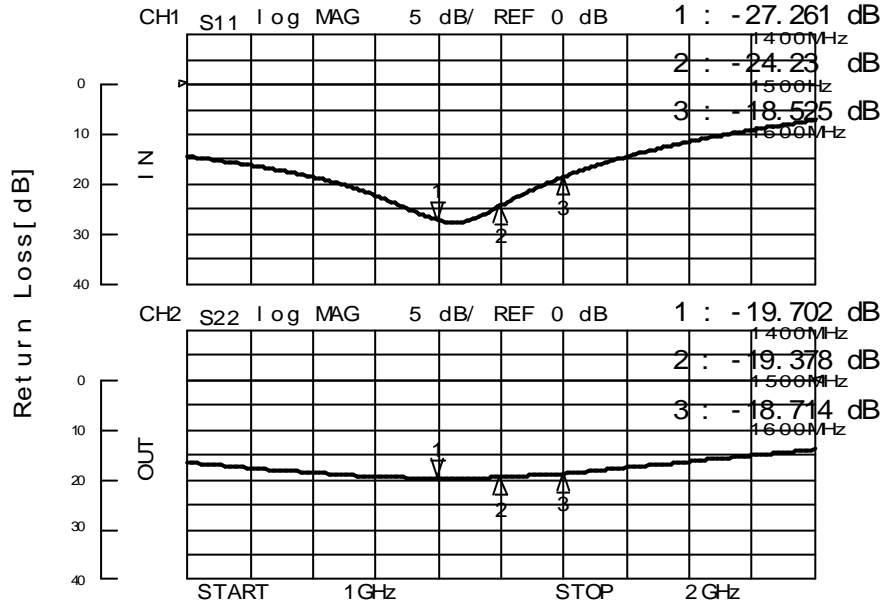

1400/1600 MHz
Chip Multilayer Splitter/Combiner "FSLH-S150C"

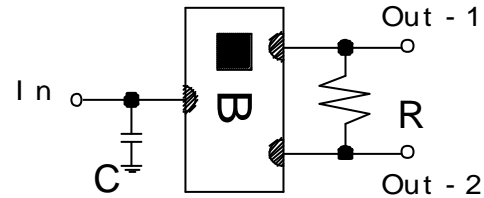

C:1.5pF
R:100 ohm

LH-FSLH-S150C-0406A