

Renesas LSIs

M5M5V5636GP –16

18874368-BIT(524288-WORD BY 36-BIT) NETWORK SRAM

DESCRIPTION

The M5M5V5636GP is a family of 18M bit synchronous SRAMs organized as 524288-words by 36-bit. It is designed to eliminate dead bus cycles when turning the bus around between reads and writes, or writes and reads. Renesas's SRAMs are fabricated with high performance, low power CMOS technology, providing greater reliability. M5M5V5636GP operates on 3.3V power/ 2.5V I/O supply or a single 3.3V power supply and are 3.3V CMOS compatible.

The M5M5V5636GP also operates on a single 2.5V power supply and is also 2.5V CMOS compatible. Therefore the M5M5V5636GP can replace the M5M5T5636GP.

The M5M5V5636GP-16 operates at 167MHz or 133MHz and is guaranteed both AC DC electrical characteristics of 167MHz and those of 133MHz.

FEATURES

- Fully registered inputs and outputs for pipelined operation
- Fast clock speed: 167 MHz and 133MHz
- Fast access time: 3.8 ns and 4.2ns
- Single 3.3V -5% and +5% power supply V_{DD}
- Separate V_{DDQ} for 3.3V or 2.5V I/O
- Single 2.5V -5% and +5% power supply V_{DD}
- Individual byte write (BWA# - BWD#) controls may be tied LOW
- Single Read/Write control pin (W#)
- CKE# pin to enable clock and suspend operations
- Internally self-timed, registers outputs eliminate the need to control G#
- Snooze mode (ZZ) for power down
- Linear or Interleaved Burst Modes
- Three chip enables for simple depth expansion

PART NAME

M5M5V5636GP-16

Operate frequency	Access	Cycle	Active Current (max.)	Standby Current (max.)
167MHz	3.8ns	6.0ns	380mA	30mA
133MHz	4.2ns	7.5ns	350mA	30mA

PACKAGE

100pin TQFP

APPLICATION

High-end networking products that require high bandwidth, such as switches and routers.

FUNCTION

Synchronous circuitry allows for precise cycle control triggered by a positive edge clock transition.

Synchronous signals include : all Addresses, all Data Inputs, all Chip Enables (E1#, E2, E3#), Address Advance/Load (ADV), Clock Enable (CKE#), Byte Write Enables (BWA#, BWB#, BWC#, BWD#) and Read/Write (W#). Write operations are controlled by the four Byte Write Enables (BWA# - BWD#) and Read/Write(W#) inputs. All writes are conducted with on-chip synchronous self-timed write circuitry.

Asynchronous inputs include Output Enable (G#), Clock (CLK) and Snooze Enable (ZZ). The HIGH input of ZZ pin puts the SRAM in the power-down state. The Linear Burst order (LBO#) is DC operated pin. LBO# pin will allow the choice of either an interleaved burst, or a linear burst.

All read, write and deselect cycles are initiated by the ADV LOW input. Subsequent burst address can be internally generated as controlled by the ADV HIGH input.

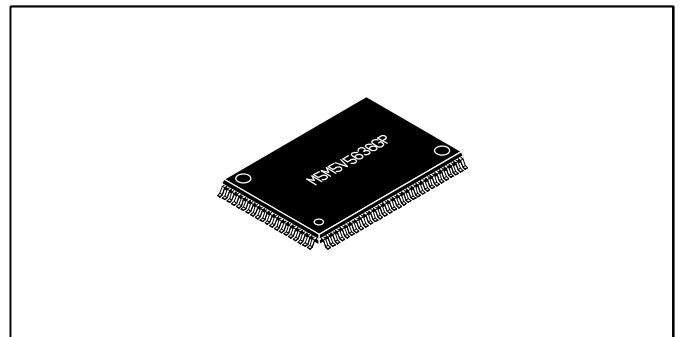

PIN CONFIGURATION(TOP VIEW)

100pin TQFP

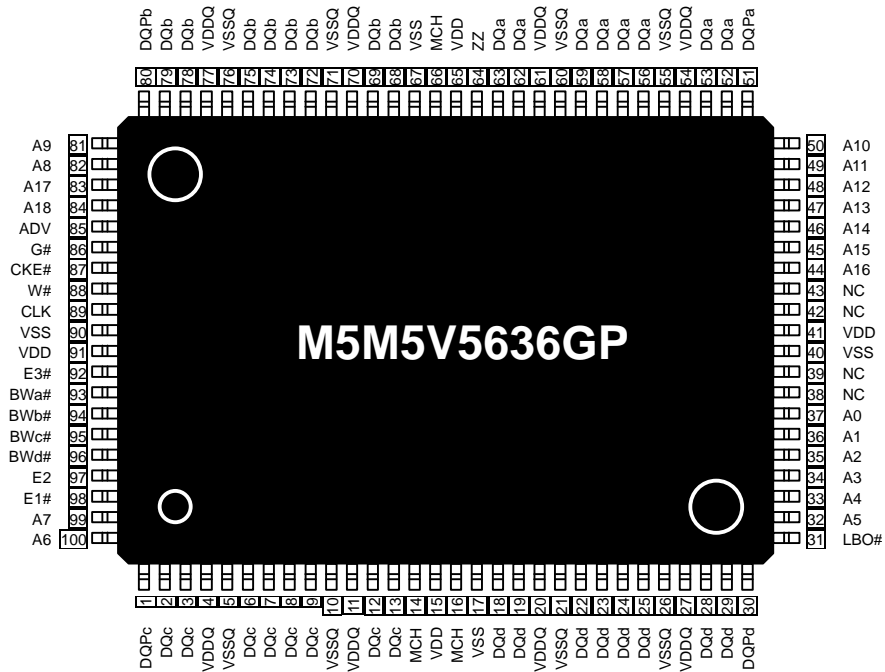

Note1. MCH means "Must Connect High". MCH should be connected to HIGH.

BLOCK DIAGRAM

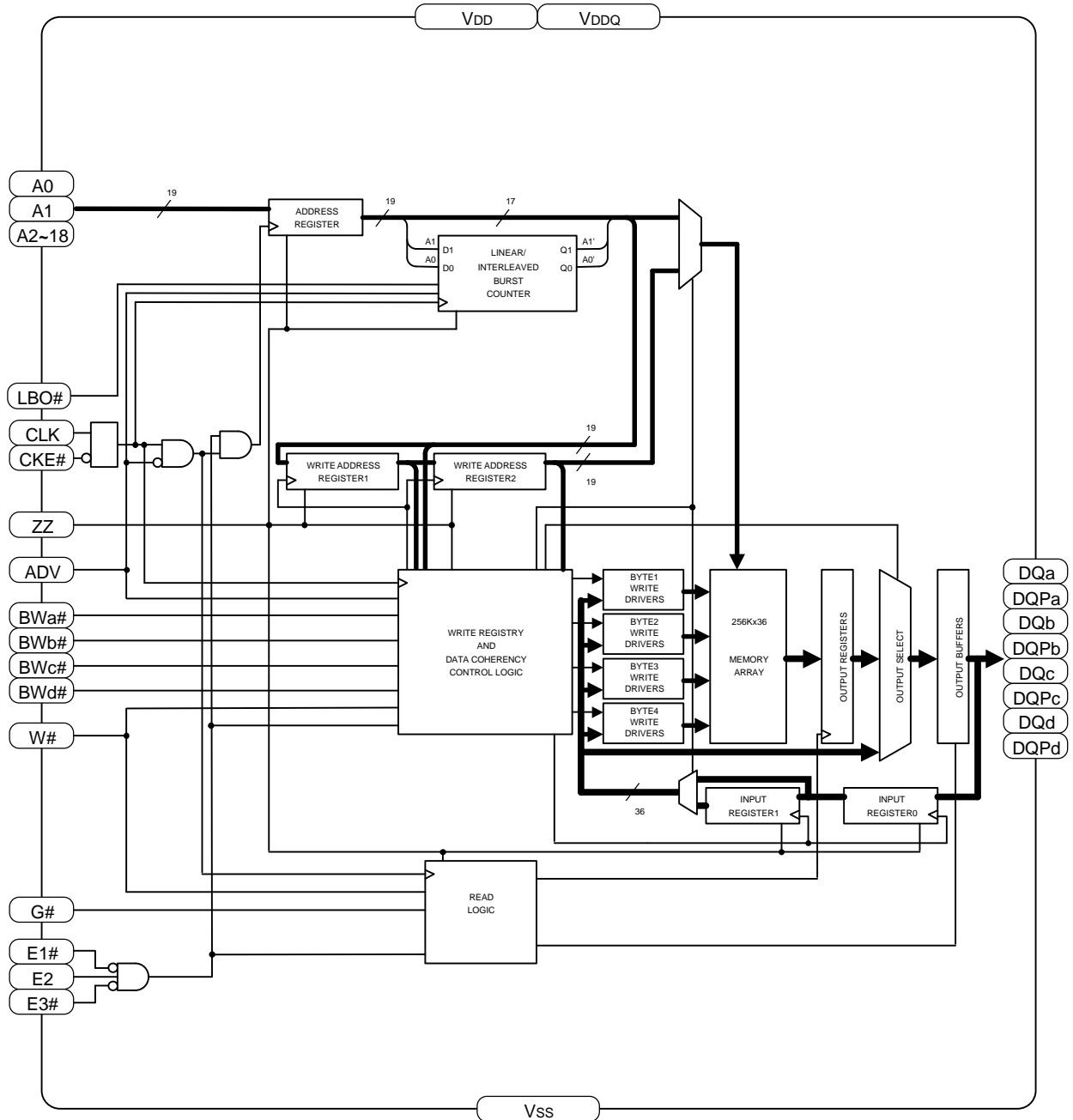

Note2. The BLOCK DIAGRAM does not include the Boundary Scan logic.

Note3. The BLOCK DIAGRAM illustrates simplified device operation. See TRUTH TABLE, PIN FUNCTION and timing diagrams for detailed information.

PIN FUNCTION

Pin	Name	Function
A0~A18	Synchronous Address Inputs	These inputs are registered and must meet the setup and hold times around the rising edge of CLK. A0 and A1 are the two least significant bits (LSB) of the address field and set the internal burst counter if burst is desired.
BWa#, BWb#, BWc#, BWd#	Synchronous Byte Write Enables	These active LOW inputs allow individual bytes to be written when a WRITE cycle is active and must meet the setup and hold times around the rising edge of CLK. BYTE WRITES need to be asserted on the same cycle as the address. BWs are associated with addresses and apply to subsequent data. BWa# controls DQa, DQP a pins; BWb# controls DQb, DQP b pins; BWc# controls DQc, DQP c pins; BWd# controls DQd, DQP d pins.
CLK	Clock Input	This signal registers the address, data, chip enables, byte write enables and burst control inputs on its rising edge. All synchronous inputs must meet setup and hold times around the clock's rising edge.
E1#	Synchronous Chip Enable	This active LOW input is used to enable the device and is sampled only when a new external address is loaded (ADV is LOW).
E2	Synchronous Chip Enable	This active High input is used to enable the device and is sampled only when a new external address is loaded (ADV is LOW). This input can be used for memory depth expansion.
E3#	Synchronous Chip Enable	This active Low input is used to enable the device and is sampled only when a new external address is loaded (ADV is LOW). This input can be used for memory depth expansion.
G#	Output Enable	This active LOW asynchronous input enable the data I/O output drivers.
ADV	Synchronous Address Advance/Load	When HIGH, this input is used to advance the internal burst counter, controlling burst access after the external address is loaded. When HIGH, W# is ignored. A LOW on this pin permits a new address to be loaded at CLK rising edge.
CKE#	Synchronous Clock Enable	This active LOW input permits CLK to propagate throughout the device. When HIGH, the device ignores the CLK input and effectively internally extends the previous CLK cycle. This input must meet setup and hold times around the rising edge of CLK.
ZZ	Snooze Enable	This active HIGH asynchronous input causes the device to enter a low-power standby mode in which all data in the memory array is retained. When active, all other inputs are ignored. When this pin is LOW or NC, the SRAM normally operates.
W#	Synchronous Read/Write	This active input determines the cycle type when ADV is LOW. This is the only means for determining READs and WRITEs. READ cycles may not be converted into WRITEs (and vice versa) other than by loading a new address. A LOW on the pin permits BYTE WRITE operations and must meet the setup and hold times around the rising edge of CLK. Full bus width WRITEs occur if all byte write enables are LOW.
DQa,DQP a,DQb,DQP b,DQc,DQP c,DQd,DQP d	Synchronous Data I/O	Byte "a" is DQa , DQP a pins; Byte "b" is DQb, DQP b pins; Byte "c" is DQc, DQP c pins; Byte "d" is DQd,DQP d pins. Input data must meet setup and hold times around CLK rising edge.
LBO#	Burst Mode Control	This DC operated pin allows the choice of either an interleaved burst or a linear burst. If this pin is HIGH or NC, an interleaved burst occurs. When this pin is LOW, a linear burst occurs, and input leak current to this pin.
VDD	VDD	Core Power Supply
VSS	VSS	Core Ground
VDDQ	VDDQ	I/O buffer Power supply
VSSQ	VSSQ	I/O buffer Ground
MCH	Must Connect High	These pins should be connected to HIGH
NC	No Connect	These pins are not internally connected and may be connected to ground.

DC OPERATED TRUTH TABLE

Name	Input Status	Operation
LBO#	HIGH or NC	Interleaved Burst Sequence
	LOW	Linear Burst Sequence

Note4. LBO# is DC operated pin.

Note5. NC means No Connection.

Note6. See BURST SEQUENCE TABLE about interleaved and Linear Burst Sequence.

BURST SEQUENCE TABLE

Interleaved Burst Sequence (when LBO# = HIGH or NC)

Operation	A18~A2	A1,A0			
First access, latch external address	A18~A2	0, 0	0, 1	1, 0	1, 1
Second access(first burst address)	latched A18~A2	0, 1	0, 0	1, 1	1, 0
Third access(second burst address)	latched A18~A2	1, 0	1, 1	0, 0	0, 1
Fourth access(third burst address)	latched A18~A2	1, 1	1, 0	0, 1	0, 0

Linear Burst Sequence (when LBO# = LOW)

Operation	A18~A2	A1,A0			
First access, latch external address	A18~A2	0, 0	0, 1	1, 0	1, 1
Second access(first burst address)	latched A18~A2	0, 1	1, 0	1, 1	0, 0
Third access(second burst address)	latched A18~A2	1, 0	1, 1	0, 0	0, 1
Fourth access(third burst address)	latched A18~A2	1, 1	0, 0	0, 1	1, 0

Note7. The burst sequence wraps around to its initial state upon completion.

TRUTH TABLE

E1#	E2	E3#	ZZ	ADV	W#	BWx#	G#	CKE#	CLK	DQ	Address used	Operation
H	X	X	L	L	X	X	X	L	L->H	High-Z	None	Deselect Cycle
X	L	X	L	L	X	X	X	L	L->H	High-Z	None	Deselect Cycle
X	X	H	L	L	X	X	X	L	L->H	High-Z	None	Deselect Cycle
X	X	X	L	H	X	X	X	L	L->H	High-Z	None	Continue Deselect Cycle
L	H	L	L	L	H	X	L	L	L->H	Q	External	Read Cycle, Begin Burst
X	X	X	L	H	X	X	L	L	L->H	Q	Next	Read Cycle, Continue Burst
L	H	L	L	L	H	X	H	L	L->H	High-Z	External	NOP/Dummy Read, Begin Burst
X	X	X	L	H	X	X	H	L	L->H	High-Z	Next	Dummy Read, Continue Burst
L	H	L	L	L	L	L	X	L	L->H	D	External	Write Cycle, Begin Burst
X	X	X	L	H	X	L	X	L	L->H	D	Next	Write Cycle, Continue Burst
L	H	L	L	L	L	H	X	L	L->H	High-Z	None	NOP/Write Abort, Begin Burst
X	X	X	L	H	X	H	X	L	L->H	High-Z	Next	Write Abort, Continue Burst
X	X	X	L	X	X	X	X	H	L->H	-	Current	Ignore Clock edge, Stall
X	X	X	H	X	X	X	X	X	X	High-Z	None	Snooze Mode

Note8. "H" = input VIH; "L" = input VIL; "X" = input VIH or VIL.

Note9. BWx#=H means all Synchronous Byte Write Enables (BWa#,BWb#,BWc#,BWd#) are HIGH. BWx#=L means one or more Synchronous Byte Write Enables are LOW.

Note10. All inputs except G# and ZZ must meet setup and hold times around the rising edge (LOW to HIGH) of CLK.

STATE DIAGRAM

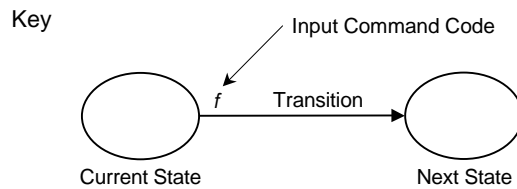
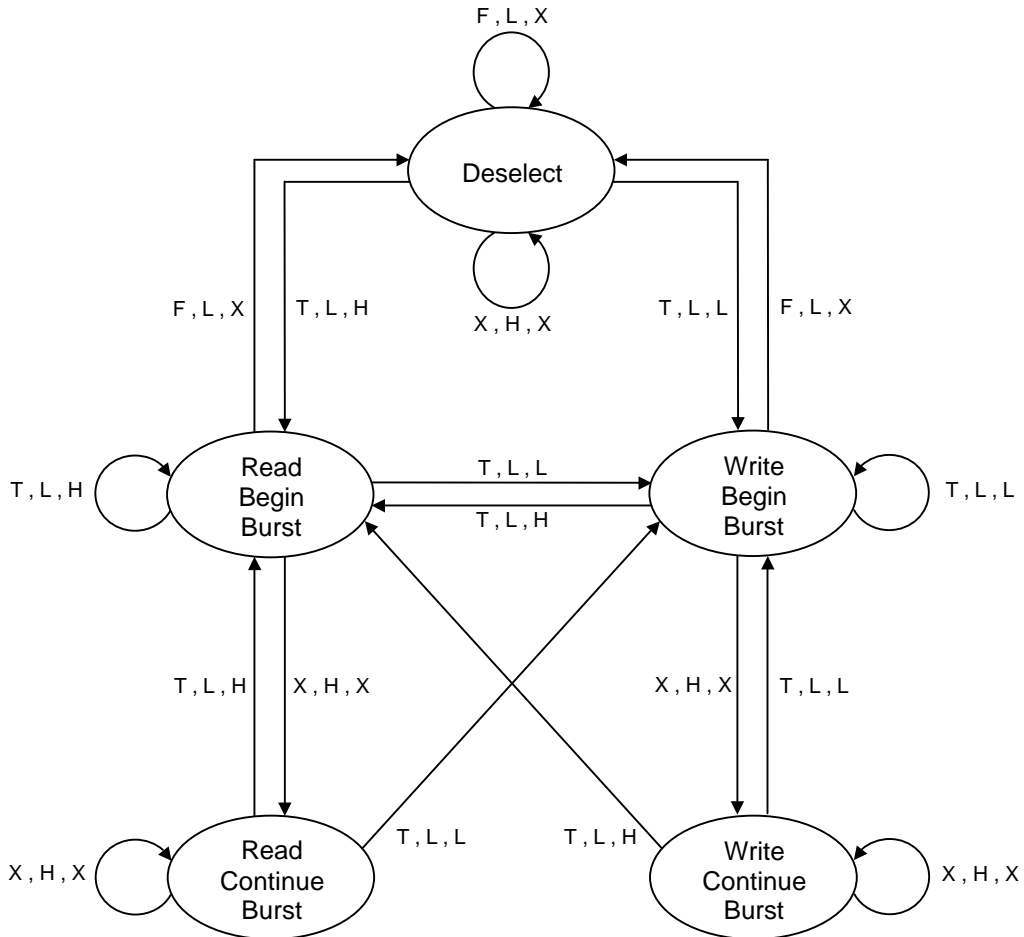

Note11. The notation "x , x , x" controlling the state transitions above indicate the state of inputs E, ADV and W# respectively.

Note12. If (E1# = L and E2 = H and E3# = L) then E="T" else E="F".

Note13. "H" = input VIH; "L" = input VIL; "X" = input VIH or VIL; "T" = input "true"; "F" = input "false".

WRITE TRUTH TABLE

W#	BWa#	BWb#	BWc#	BWd#	Function
H	X	X	X	X	Read
L	L	H	H	H	Write Byte a
L	H	L	H	H	Write Byte b
L	H	H	L	H	Write Byte c
L	H	H	H	L	Write Byte d
L	L	L	L	L	Write All Bytes
L	H	H	H	H	Write Abort/NOP

Note14. "H" = input VIH; "L" = input VIL; "X" = input VIH or VIL.

Note15. All inputs except G# and ZZ must meet setup and hold times around the rising edge (LOW to HIGH) of CLK.

ABSOLUTE MAXIMUM RATINGS

Symbol	Parameter	Conditions	Ratings	Unit
VDD	Power Supply Voltage	With respect to Vss	-1.0*~4.6	V
VDDQ	I/O Buffer Power Supply Voltage		-1.0*~4.6	V
Vi	Input Voltage		-1.0~VDDQ+1.0**	V
VO	Output Voltage		-1.0~VDDQ+1.0**	V
PD	Maximum Power Dissipation (VDD)		1.6	W
TOPR	Operating Temperature		0~70	°C
TSTG(bias)	Storage Temperature(bias)		-10~85	°C
TSTG	Storage Temperature		-65~150	°C

Note16.* This is -1.0V when pulse width≤2ns, and -0.5V in case of DC.

** This is -1.0V~VDDQ+1.0V when pulse width≤2ns, and -0.5V~VDDQ+0.5V in case of DC.

DC ELECTRICAL CHARACTERISTICS 1 (Ta=0~70°C, VDD=3.135~3.465V, unless otherwise noted)

Symbol	Parameter	Condition	Limits		Unit
			Min	Max	
VDD	Power Supply Voltage		3.135	3.465	V
VDDQ	I/O Buffer Power Supply Voltage	VDDQ = 3.3V	3.135	3.465	V
		VDDQ = 2.5V	2.375	2.625	
VIH	High-level Input Voltage	VDDQ = 3.135~3.465V	2.0	VDDQ+0.3*	V
		VDDQ = 2.375~2.625V	1.7		
VIL	Low-level Input Voltage	VDDQ = 3.135~3.465V	-0.3*	0.8	V
		VDDQ = 2.375~2.625V		0.7	
VOH	High-level Output Voltage	IOH = -2.0mA	VDDQ-0.4		V
VOL	Low-level Output Voltage	IOL = 2.0mA		0.4	V
ILI	Input Leakage Current except ZZ and LBO#	VI = 0V ~ VDDQ		10	μA
	Input Leakage Current of LBO#	VI = 0V ~ VDDQ		100	
	Input Leakage Current of ZZ	VI = 0V ~ VDDQ		100	
ILO	Off-state Output Current	VI (G#) ≥ VIH, VO = 0V ~ VDDQ		10	μA
ICC1	Power Supply Current : Operating	Device selected; Output Open VI ≤ VIL or VI ≥ VIH ZZ ≤ VIL	6.0ns cycle(167MHz)	380	mA
			7.5ns cycle(133MHz)	350	
ICC2	Power Supply Current : Deselected	Device deselected VI ≤ VIL or VI ≥ VIH ZZ ≤ VIL	6.0ns cycle(167MHz)	160	mA
			7.5ns cycle(133MHz)	130	
ICC3	CMOS Standby Current (CLK stopped standby mode)	Device deselected; Output Open VI ≤ VSS+0.2V or VI ≥ VDDQ-0.2V CLK frequency=0Hz, All inputs static		30	mA
ICC4	Snooze Mode Standby Current	Snooze mode ZZ ≥ VDDQ-0.2V, LBO# ≥ VDD-0.2V		30	mA
ICC5	Stall Current	Device selected; Output Open CKE# ≥ VIH VI ≤ VSS+0.2V or VI ≥ VDDQ-0.2V	6.0ns cycle(167MHz)	130	mA
			7.5ns cycle(133MHz)	120	

Note17: *VILmin is -1.0V and VIHmax is VDDQ+1.0V in case of AC(Pulse width ≤ 2ns).

Note18: "Device Deselected" means device is in power-down mode as defined in the truth table.

DC ELECTRICAL CHARACTERISTICS 2 (Ta=0~70°C, VDD=2.375~2.625V, unless otherwise noted)

Symbol	Parameter	Condition	Limits		Unit
			Min	Max	
VDD	Power Supply Voltage		2.375	2.625	V
VDDQ	I/O Buffer Power Supply Voltage		2.375	2.625	V
V _{IH}	High-level Input Voltage		1.7	VDDQ+0.3*	V
V _{IL}	Low-level Input Voltage		-0.3*	0.7	V
V _{OH}	High-level Output Voltage	I _{OH} = -2.0mA	VDDQ-0.4		V
V _{OL}	Low-level Output Voltage	I _{OL} = 2.0mA		0.4	V
I _{LI}	Input Leakage Current except ZZ and LBO#	V _I = 0V ~ VDDQ		10	μA
	Input Leakage Current of LBO#	V _I = 0V ~ VDDQ		100	
	Input Leakage Current of ZZ	V _I = 0V ~ VDDQ		100	
I _{LO}	Off-state Output Current	V _I (G#) ≥ V _{IH} , V _O = 0V ~ VDDQ		10	μA
I _{CC1}	Power Supply Current : Operating	Device selected; Output Open, V _I ≤ V _{IL} or V _I ≥ V _{IH} , ZZ ≤ V _{IL}	6.0ns cycle(167MHz)	380	mA
			7.5ns cycle(133MHz)	350	
I _{CC2}	Power Supply Current : Deselected	Device deselected V _I ≤ V _{IL} or V _I ≥ V _{IH} , ZZ ≤ V _{IL}	6.0ns cycle(167MHz)	160	mA
			7.5ns cycle(133MHz)	130	
I _{CC3}	CMOS Standby Current (CLK stopped standby mode)	Device deselected; Output Open V _I ≤ V _{SS} +0.2V or V _I ≥ VDDQ-0.2V CLK frequency=0Hz, All inputs static		30	mA
I _{CC4}	Snooze Mode Standby Current	Snooze mode ZZ ≥ VDDQ-0.2V, LBO# ≥ VDD-0.2V		30	mA
I _{CC5}	Stall Current	Device selected; Output Open, CKE# ≥ V _{IH} V _I ≤ V _{SS} +0.2V or V _I ≥ VDDQ-0.2V	6.0ns cycle(167MHz)	130	mA
			7.5ns cycle(133MHz)	120	

Note17.*V_{ILmin} is -1.0V and V_{IHmax} is VDDQ+1.0V in case of AC(Pulse width ≤ 2ns).

Note18."Device Deselected" means device is in power-down mode as defined in the truth table.

CAPACITANCE

Symbol	Parameter	Conditions	Limits			Unit
			Min	Typ	Max	
C _I	Input Capacitance	V _I =GND, V _I =25mVrms, f=1MHz			6	pF
C _O	Input / Output(DQ) Capacitance	V _O =GND, V _O =25mVrms, f=1MHz			8	pF

Note19.This parameter is sampled.

THERMAL RESISTANCE

4-Layer PC board mounted (70x70x1.6mmT)

Symbol	Parameter	Conditions	Limits			Unit
			Min	Typ	Max	
θ _{JA}	Thermal Resistance Junction Ambient	Air velocity=0m/sec		28		°C/W
		Air velocity=2m/sec		20		°C/W
θ _{JC}	Thermal Resistance Junction to Case			6.6		°C/W

Note20.This parameter is sampled.

AC ELECTRICAL CHARACTERISTICS (T_a=0~70°C, V_{DD}=3.135~3.465V or V_{DD}=2.375~2.625V, unless otherwise noted)

(1)MEASUREMENT CONDITION

- Input pulse levels V_{IH}=V_{DDQ}, V_{IL}=0V
- Input rise and fall times faster than or equal to 1V/ns
- Input timing reference levels V_{IH}=V_{IL}=0.5*V_{DDQ}
- Output reference levels V_{IH}=V_{IL}=0.5*V_{DDQ}
- Output load Fig.1

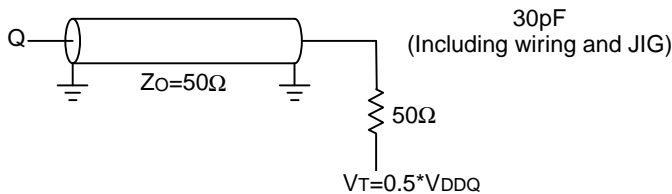

Fig.1 Output load

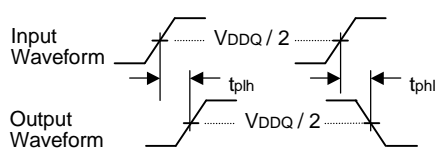

Fig.2 Tdly measurement

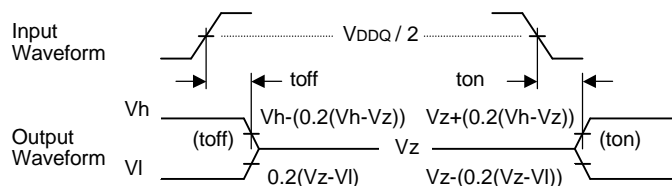

Fig.3 Tri-State measurement

Note21.Valid Delay Measurement is made from the V_{DDQ}/2 on the input waveform to the V_{DDQ}/2 on the output waveform.

Input waveform should have a slew rate of faster than or equal to 1V/ns.

Note22.Tri-state toff measurement is made from the V_{DDQ}/2 on the input waveform to the output waveform moving 20% from its initial to final Value V_{DDQ}/2.

Note:the initial value is not VOL or VOH as specified in DC ELECTRICAL CHARACTERISTICS table.

Note23. Tri-state ton measurement is made from the V_{DDQ}/2 on the input waveform to the output waveform moving 20% from its initial Value V_{DDQ}/2 to its final Value.

Note:the final value is not VOL or VOH as specified in DC ELECTRICAL CHARACTERISTICS table.

Note24.Clocks,Data,Address and control signals will be tested with a minimum input slew rate of faster than or equal to 1V/ns.

(2)TIMING CHARACTERISTICS

Symbol	Parameter	Limits				Unit
		167MHz		133MHz		
		-16		-16		
		Min	Max	Min	Max	
Clock						
tKHKH	Clock cycle time	6.0		7.5		ns
tKHKL	Clock HIGH time	2.7		3.0		ns
tKLKH	Clock LOW time	2.7		3.0		ns
Output times						
tKHQV	Clock HIGH to output valid		3.8		4.2	ns
tKHQX	Clock HIGH to output invalid	1.5		1.5		ns
tKHQX1	Clock HIGH to output in LOW-Z	1.5		1.5		ns
tKHQZ	Clock HIGH to output in High-Z	1.5	3.8	1.5	4.2	ns
tGLQV	G# to output valid		3.8		4.2	ns
tGLQX1	G# to output in Low-Z	0.0		0.0		ns
tGHQZ	G# to output in High-Z		3.8		4.2	ns
Setup Times						
tAVKH	Address valid to clock HIGH	1.2		1.2		ns
tckeVKH	CKE# valid to clock HIGH	1.2		1.2		ns
tadvVKH	ADV valid to clock HIGH	1.2		1.2		ns
tWVKH	Write valid to clock HIGH	1.2		1.2		ns
tBVKH	Byte write valid to clock HIGH (BWA#~BWd#)	1.2		1.2		ns
tEVKH	Enable valid to clock HIGH (E1#,E2,E3#)	1.2		1.2		ns
tDVKH	Data In valid clock HIGH	1.2		1.2		ns
Hold Times						
tKHAX	Clock HIGH to Address don't care	0.8		0.8		ns
tKHckeX	Clock HIGH to CKE# don't care	0.8		0.8		ns
tKHadvX	Clock HIGH to ADV don't care	0.8		0.8		ns
tKHWX	Clock HIGH to Write don't care	0.8		0.8		ns
tKHBX	Clock HIGH to Byte Write don't care (BWA#~BWb#)	0.8		0.8		ns
tKHEX	Clock HIGH to Enable don't care (E1#,E2,E3#)	0.8		0.8		ns
tKHDX	Clock HIGH to Data In don't care	0.8		0.8		ns
ZZ						
tZZS	ZZ standby		2*tKHKH		2*tKHKH	ns
tZZREC	ZZ recovery		2*tKHKH		2*tKHKH	ns

Note25.All parameter except tZZS, tZZREC in this table are measured on condition that ZZ=LOW fix.

Note26.Test conditions is specified with the output loading shown in Fig.1 unless otherwise noted.

Note27. tKHQX1, tKHQZ, tGLQX1, tGHQZ are sampled.

Note28.LBO# is static and must not change during normal operation.

(6)SNOOZE MODE TIMING

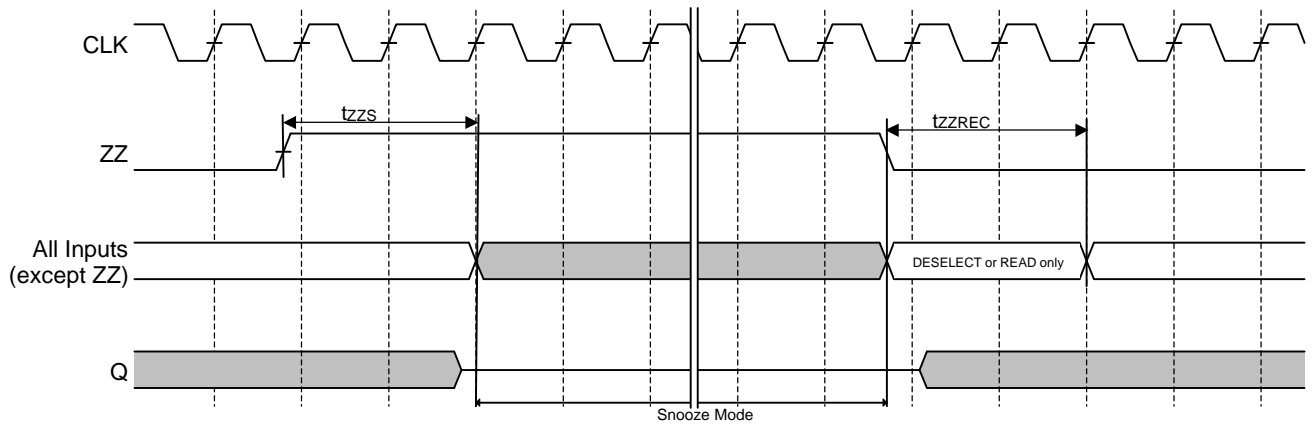

PACKAGE OUTLINE

Plastic 100pin 14x20 mm body

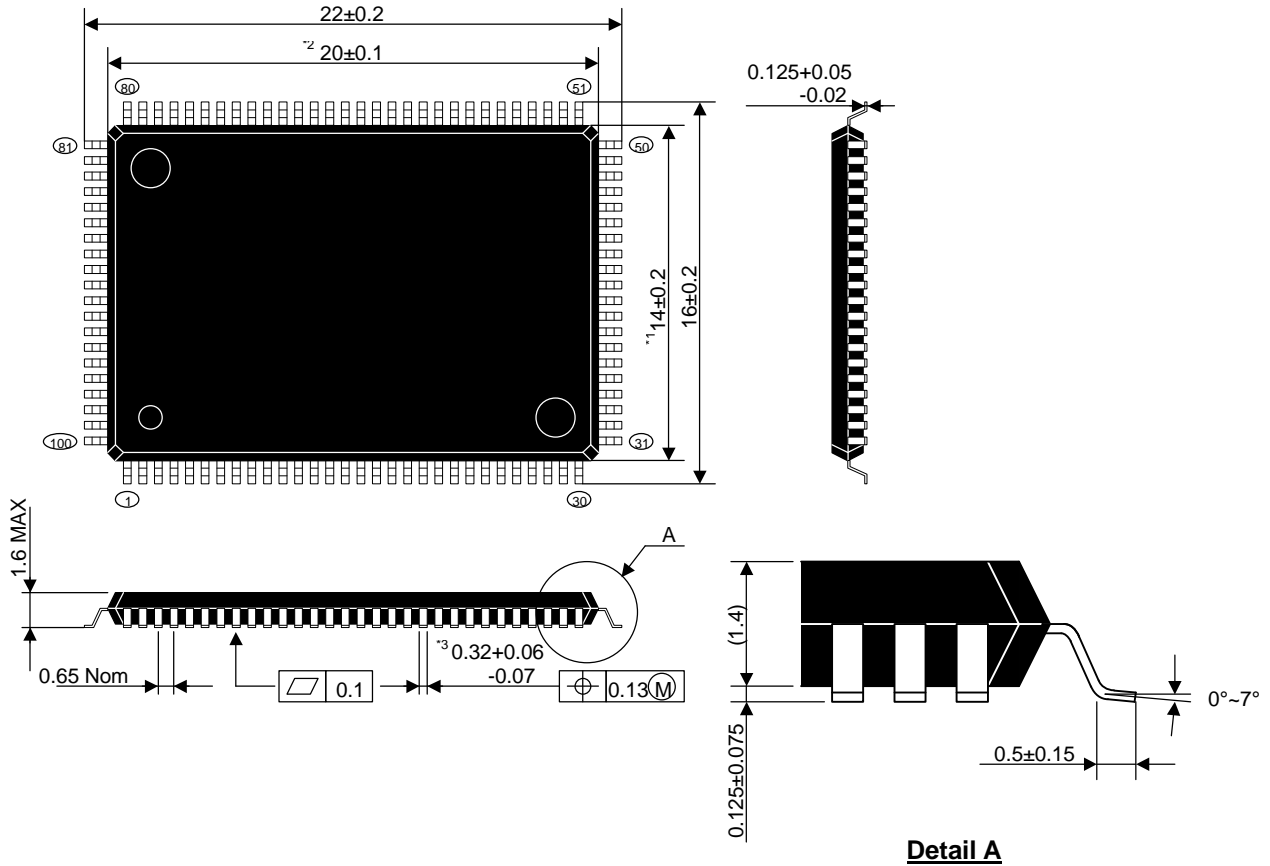

Note38. Dimensions *1 and *2 don't include mold flash.
 Note39 Dimension *3 doesn't include trim off set.
 Note40. All dimensions in millimeters.

Renesas LSIs
M5M5V5636GP –16

18874368-BIT(524288-WORD BY 36-BIT) NETWORK SRAM

REVISION HISTORY

Rev. No.	History	Date	
0.0	First revision	June 4, 2001	Advanced Information
0.1	Fixed WRITE TRUTH TABLE	July 16, 2001	Advanced Information
0.2	Fixed Note8,13 and 14	March 28, 2002	Advanced Information
0.3	Add –13(133MHz) Fixed THERMAL RESISTANCE Preliminary	July 5, 2002	Preliminary
0.4	DC ELECTRICAL CHARACTERISTICS Changed VIH limit from 0.65VDDQ to 2.0 at 3.3V VDDQ Changed VIH limit from 0.65VDDQ to 1.7 at 2.5V VDDQ Changed VIL limit from 0.35VDDQ to 0.8 at 3.3V VDDQ Changed VIL limit from 0.35VDDQ to 0.7 at 2.5V VDDQ Changed ICC1 limit from 340mA to 380mA at 167MHz(-16) Changed ICC1 limit from 320mA to 350mA at 133MHz(-13) Changed ICC2 limit from 90mA to 160mA at 167MHz(-16) Changed ICC2 limit from 80mA to 130mA at 133MHz(-13) Changed ICC5 limit from 45mA to 130mA at 167MHz(-16) Changed ICC5 limit from 40mA to 120mA at 133MHz(-13) AC ELECTRICAL CHARACTERISTICS Changed tKHKL limit from 2.0ns to 2.7ns at 167MHz(-16) Changed tCLKH limit from 2.0ns to 2.7ns at 167MHz(-16) Changed tKHQX limit from 0.8ns to 1.5ns Changed tKHQX1 limit from 0.8ns to 1.5ns Changed tKHQZ limit from 0.8ns to 1.5ns	August 6, 2002	Preliminary
0.5	DC ELECTRICAL CHARACTERISTICS Changed ILI limit from 10uA to 100uA (Input Leakage Current of ZZ and LBO#) Changed Icc3 and Icc4 limit from 20mA to 30mA (Standby Current)	January 14, 2003	Preliminary
1.0	The semiconductor operations of HITACHI and MITSUBISHI Electric were transferred to RENESAS Technology Corporation on April 1st 2003. AC ELECTRICAL CHARACTERISTICS Changed all Setup times from 1.5ns to 1.2ns at 167MHz(-16). Changed all Hold times from 0.5ns to 0.8ns at 167MHz(-16). Changed all Setup times from 1.5ns to 1.2ns at 133MHz(-13). Changed all Hold times from 0.5ns to 0.8ns at 133MHz(-13).	August 1, 2003	Preliminary
2.0	Eliminate preliminary Be guaranteed 2.5V operation Eliminate M5M5V5636GP-13 Changed PD(Maximum Power Dissipation) from 1180mW to 1.6W	March 15, 2004	

Renesas Technology Corp.

Nippon Bldg.,6-2,Oteamchi 2-chome,Chiyoda-ku,Tokyo,100-0004 Japan

Keep safety first in your circuit designs!

- Renesas Technology Corporation puts the maximum effort into making semiconductor products better and more reliable, but there is always the possibility that trouble may occur with them. Trouble with semiconductors may lead to personal injury, fire or property damage. Remember to give due consideration to safety when making your circuit designs, with appropriate measures such as (i) placement of substitutive, auxiliary circuits, (ii) use of nonflammable material or (iii) prevention against any malfunction or mishap.

Notes regarding these materials

- These materials are intended as a reference to assist our customers in the selection of the Renesas Technology Corporation product best suited to the customer's application; they do not convey any license under any intellectual property rights, or any other rights, belonging to Renesas Technology Corporation or a third party.
- Renesas Technology Corporation assumes no responsibility for any damage, or infringement of any third-party's rights, originating in the use of any product data, diagrams, charts, programs, algorithms, or circuit application examples contained in these materials.
- All information contained in these materials, including product data, diagrams, charts, programs and algorithms represents information on products at the time of publication of these materials, and are subject to change by Renesas Technology Corporation without notice due to product improvements or other reasons. It is therefore recommended that customers contact Renesas Technology Corporation or an authorized Renesas Technology Corporation product distributor for the latest product information before purchasing a product listed herein. The information described here may contain technical inaccuracies or typographical errors. Renesas Technology Corporation assumes no responsibility for any damage, liability, or other loss arising from these inaccuracies or errors. Please also pay attention to information published by Renesas Technology Corporation by various means, including the Renesas Technology Corporation Semiconductor home page (<http://www.renesas.com>).
- When using any or all of the information contained in these materials, including product data, diagrams, charts, programs, and algorithms, please be sure to evaluate all information as a total system before making a final decision on the applicability of the information and products. Renesas Technology Corporation assumes no responsibility for any damage, liability or other loss resulting from the information contained herein.
- Renesas Technology Corporation semiconductors are not designed or manufactured for use in a device or system that is used under circumstances in which human life is potentially at stake. Please contact Renesas Technology Corporation or an authorized Renesas Technology Corporation product distributor when considering the use of a product contained herein for any specific purposes, such as apparatus or systems for transportation, vehicular, medical, aerospace, nuclear, or undersea repeater use.
- The prior written approval of Renesas Technology Corporation is necessary to reprint or reproduce in whole or in part these materials.
- If these products or technologies are subject to the Japanese export control restrictions, they must be exported under a license from the Japanese government and cannot be imported into a country other than the approved destination. Any diversion or reexport contrary to the export control laws and regulations of Japan and/or the country of destination is prohibited.
- Please contact Renesas Technology Corporation for further details on these materials or the products contained therein.

REJ03C0074

© 2003 Renesas Technology Corp.

New publication, effective March 2004.

Specifications subject to change without notice.