

M/A-COM 5-Bit Digital Phase Shifter

6.0-18.0 GHz

Preliminary Information

MAPCGM0004-DIE

Features

- ◆ 5 Bit Digital Phase Shifter
- ◆ 6.0 -18.0 GHz Operation
- ◆ 360° Coverage, LSB = 11.2°
- ◆ TTL Control Inputs
- ◆ Self-Aligned MSAG[®] MESFET Process

Primary Applications

- ◆ Satellite Communication
- ◆ Phased Array Radar
- ◆ Electronic Warfare

Description

The MAPCGM0004-Die is a 5-bit Phase Shifter with Parallel TTL Input Control. This product is fully matched to 50 ohms on both the input and output. The part has 360° of phase coverage with LSB of 11.2°.

Each device is 100% RF tested on wafer to ensure performance compliance. The part is fabricated using M/A-COM's repeatable, high performance and highly reliable GaAs Multifunction Self-Aligned Gate (MSAG[®]) MESFET Process.

6.0-18.0 GHz GaAs MMIC Phase

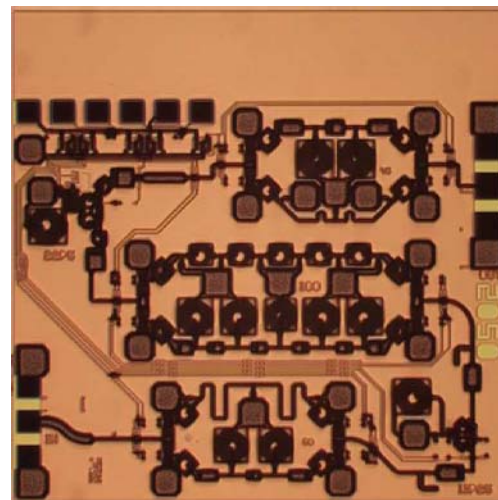

Electrical Characteristics: $T_B = 40^\circ\text{C}^1$, $Z_0 = 50\Omega$, $V_{EE} = -5\text{V}$

Parameter	Symbol	Typical	Units
Bandwidth	f	6.0 -18.0	GHz
Insertion Loss @ 12 GHz, Reference State	IL	12	dB
Insertion Loss @ 18 GHz, Reference State	IL	17	dB
Input VSWR, All States	VSWR	1.6:1	
Output VSWR, All States	VSWR	1.6:1	
RMS Phase Error	ϕ_{RMS}	10	°
RMS Phase Error, Calibrated	ϕ_{RMS}	6	°
Peak to Peak Gain Variation, All States	ΔG	< 2	dB
Current	I_{EE}	< 10	mA
Input Third Order Intercept	ITOI	30	dBm
Input 1-dB Compression Point	P1dB	19	dBm

1. T_B = MMIC Base Temperature

Maximum Operating Conditions ¹

Parameter	Symbol	Absolute Maximum	Units
Input Power	P_{IN}	24	dBm
Source Supply Voltage	V_{EE}	-6.0	V
Junction Temperature	T_j	180	°C
Storage Temperature	T_{STG}	-55 to +150	°C

1. Operation outside of these ranges may reduce product reliability. Operation at other than the typical values may result in performance outside the guaranteed limits.

Recommended Operating Conditions

Characteristic	Symbol	Min	Typ	Max	Unit
Source Voltage	V_{EE}	-5.2	-5	-4.8	V
Control Voltage	$V_{control\ pads}$				
Logic High		3	5	5	V
Logic Low		0	0	0.4	V

Operating Instructions

This device is static and light sensitive. Digital circuit operation can be impaired under high intensity light, e.g. microscope light. Please handle with care. To operate the device, follow these steps.

1. Power Up: Apply $V_{EE} = -5$ V.
2. Apply Logic Voltages to control Circuits as listed in Recommended Operating Conditions
3. Power Down: Set $V_{EE} = 0$

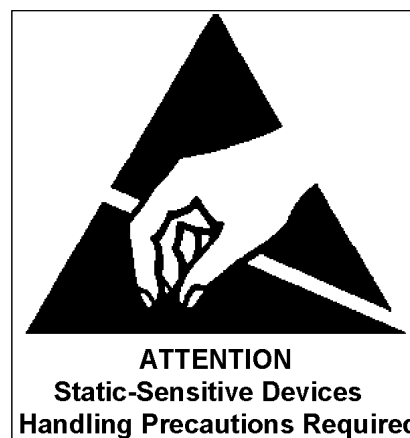

Specifications subject to change without notice.

Customer Service: Tel. (888)-563-3949

Email: macom_adbu_ics@tycoelectronics.com

- **North America:** Tel. (800) 366-2266
- **Asia/Pacific:** Tel. +81-44-844-8296, Fax +81-44-844-8298
- **Europe:** Tel. +44 (1344) 869 595, Fax+44 (1344) 300 020

tyco / Electronics

MACOM

Visit www.macom.com for additional data sheets and product information.

5-Bit Digital Phase Shifter

MAPCGM0004-DIE

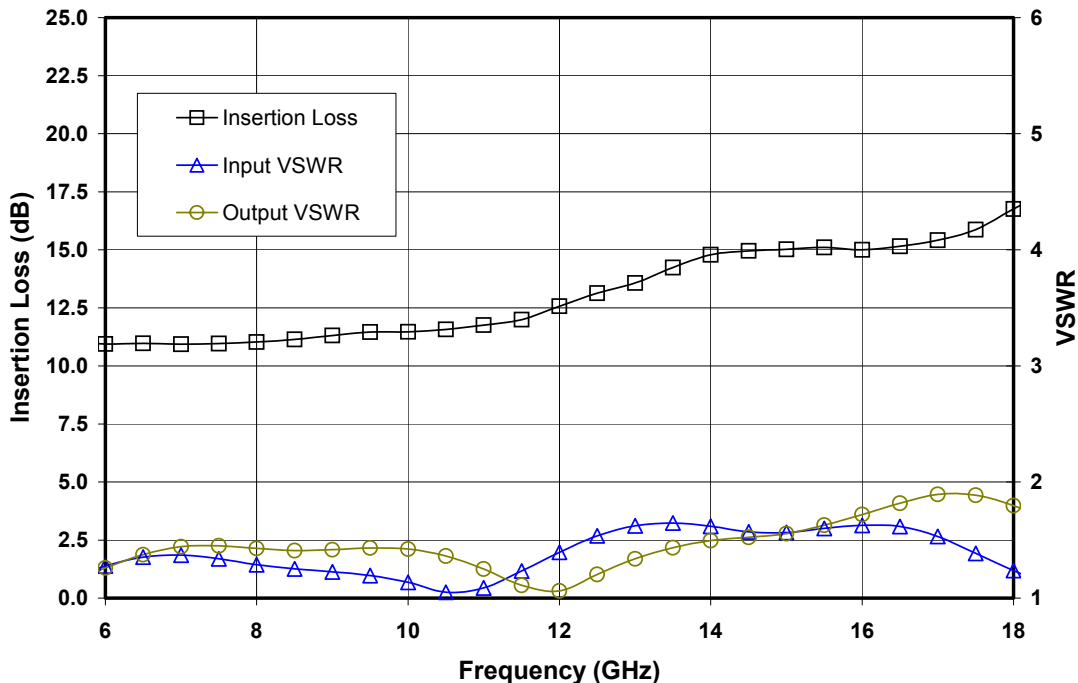

Figure 1. Reference State Insertion Loss, Input and Output VSWR vs. Frequency

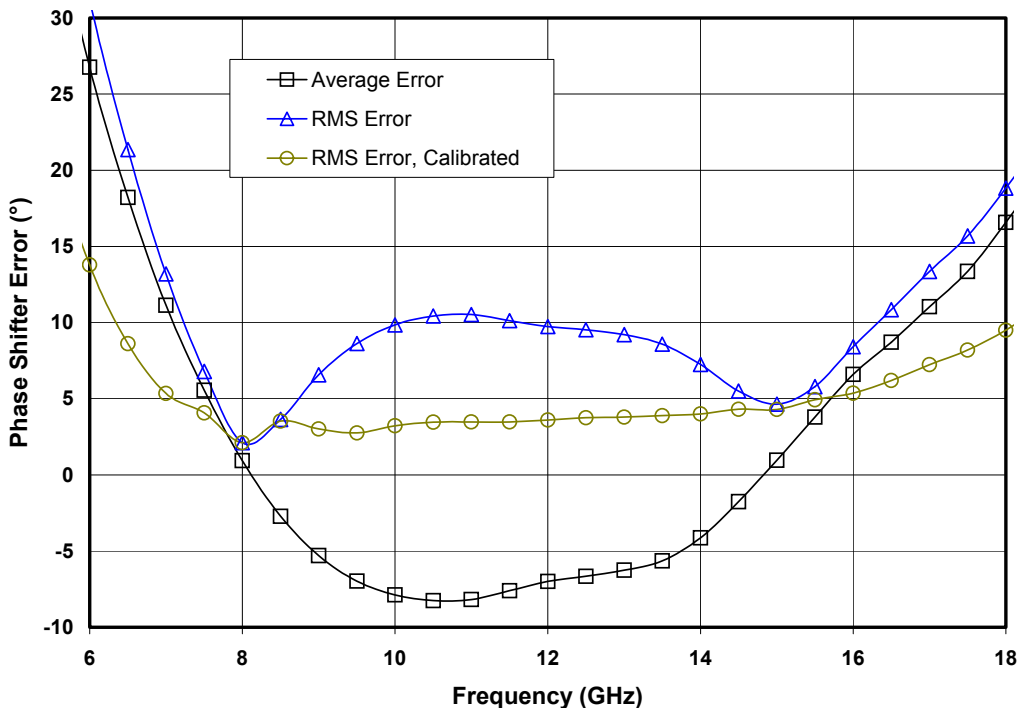

Figure 2. Phase Shifter Figures of Merit: Average Error vs Reference State, RMS Error and Calibrated RMS Error over All States

Specifications subject to change without notice.

Customer Service: Tel. (888)-563-3949

Email: macom_adbu_ics@tycoelectronics.com

- North America: Tel. (800) 366-2266
- Asia/Pacific: Tel. +81-44-844-8296, Fax +81-44-844-8298
- Europe: Tel. +44 (1344) 869 595, Fax+44 (1344) 300 020



Visit www.macom.com for additional data sheets and product information.

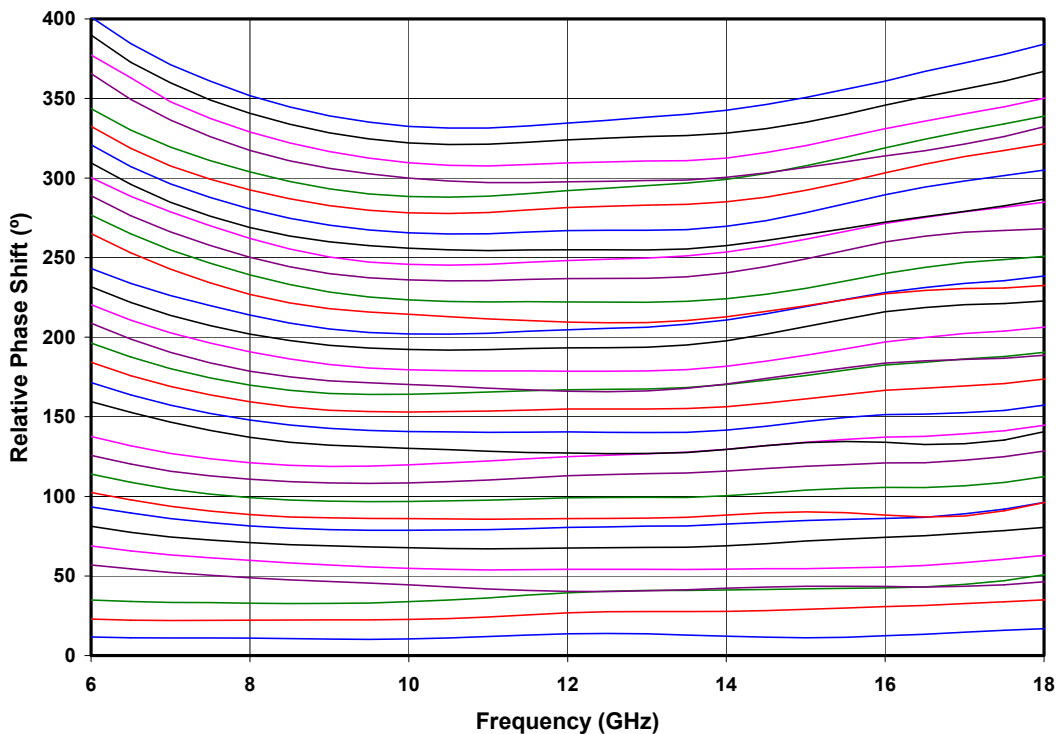

Figure 3. Relative Phase vs. Phase Shifter State

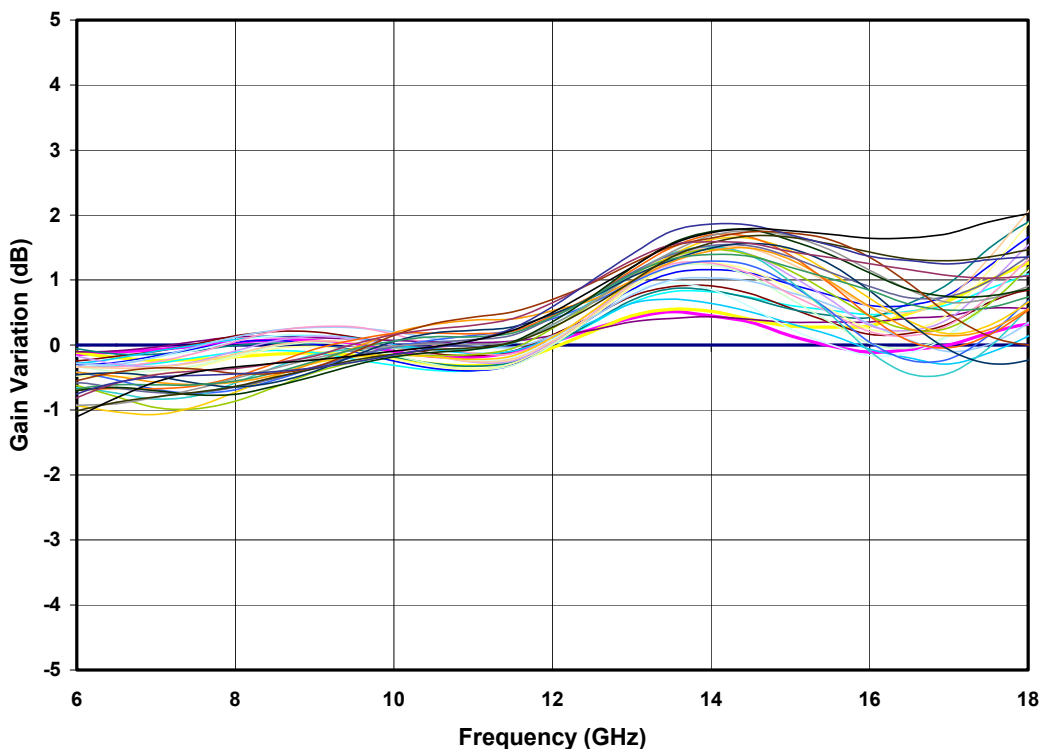

Figure 4. Relative Gain Change vs Phase Shifter State

Specifications subject to change without notice.

Customer Service: Tel. (888)-563-3949

Email: macom_adbu_ics@tycoelectronics.com

- North America: Tel. (800) 366-2266
- Asia/Pacific: Tel. +81-44-844-8296, Fax +81-44-844-8298
- Europe: Tel. +44 (1344) 869 595, Fax+44 (1344) 300 020



Visit www.macom.com for additional data sheets and product information.

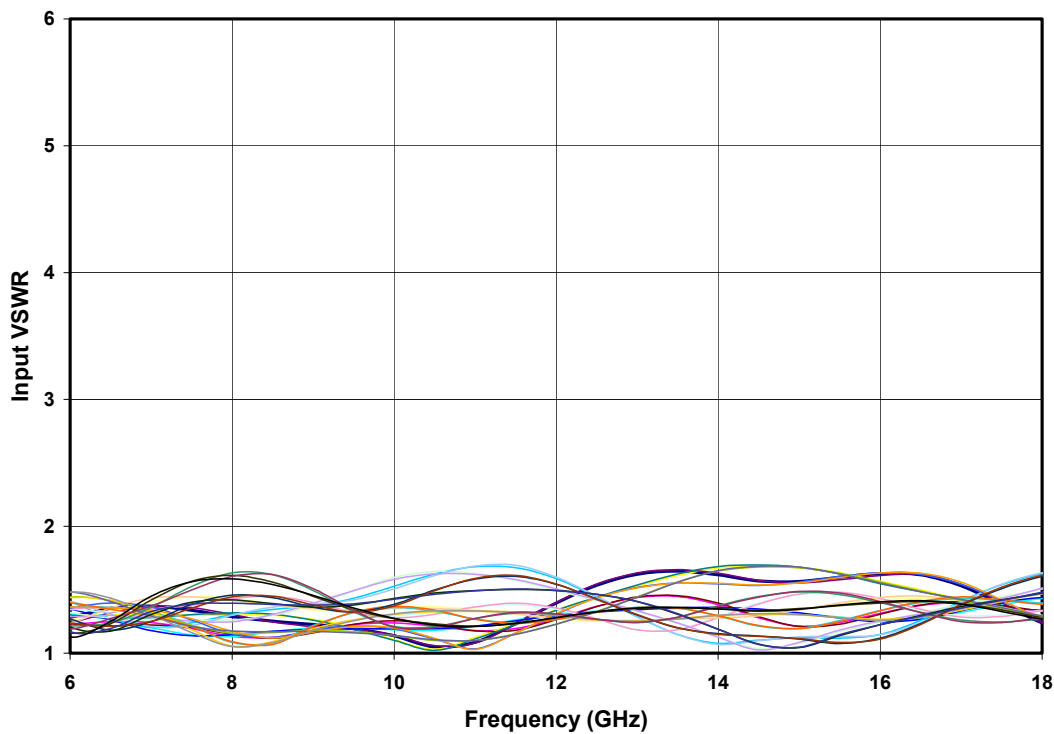

Figure 5. Input VSWR vs Phase Shifter State

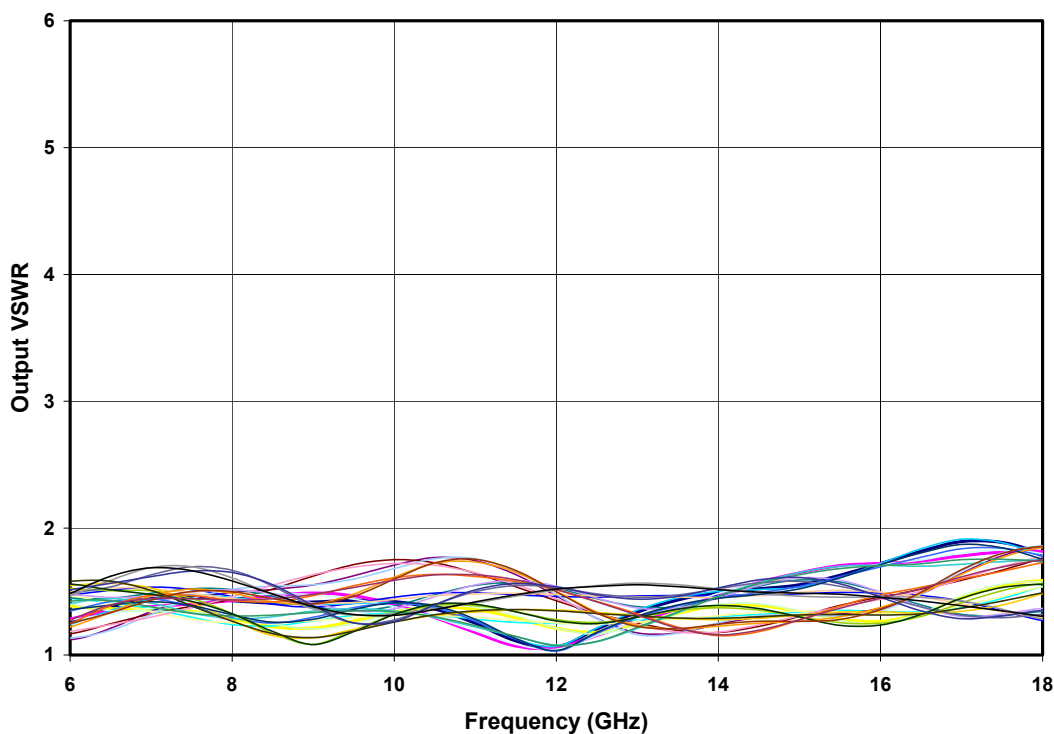

Figure 6. Output VSWR vs Phase Shifter State

Specifications subject to change without notice.

Customer Service: Tel. (888)-563-3949

Email: macom_adbu_ics@tycoelectronics.com

- North America: Tel. (800) 366-2266
- Asia/Pacific: Tel. +81-44-844-8296, Fax +81-44-844-8298
- Europe: Tel. +44 (1344) 869 595, Fax +44 (1344) 300 020

tyco / Electronics

MACOM

Visit www.macom.com for additional data sheets and product information.

Mechanical Information

Chip Size: 2.962 x 2.949 x 0.075 mm (116 x 116 x 3 mils)

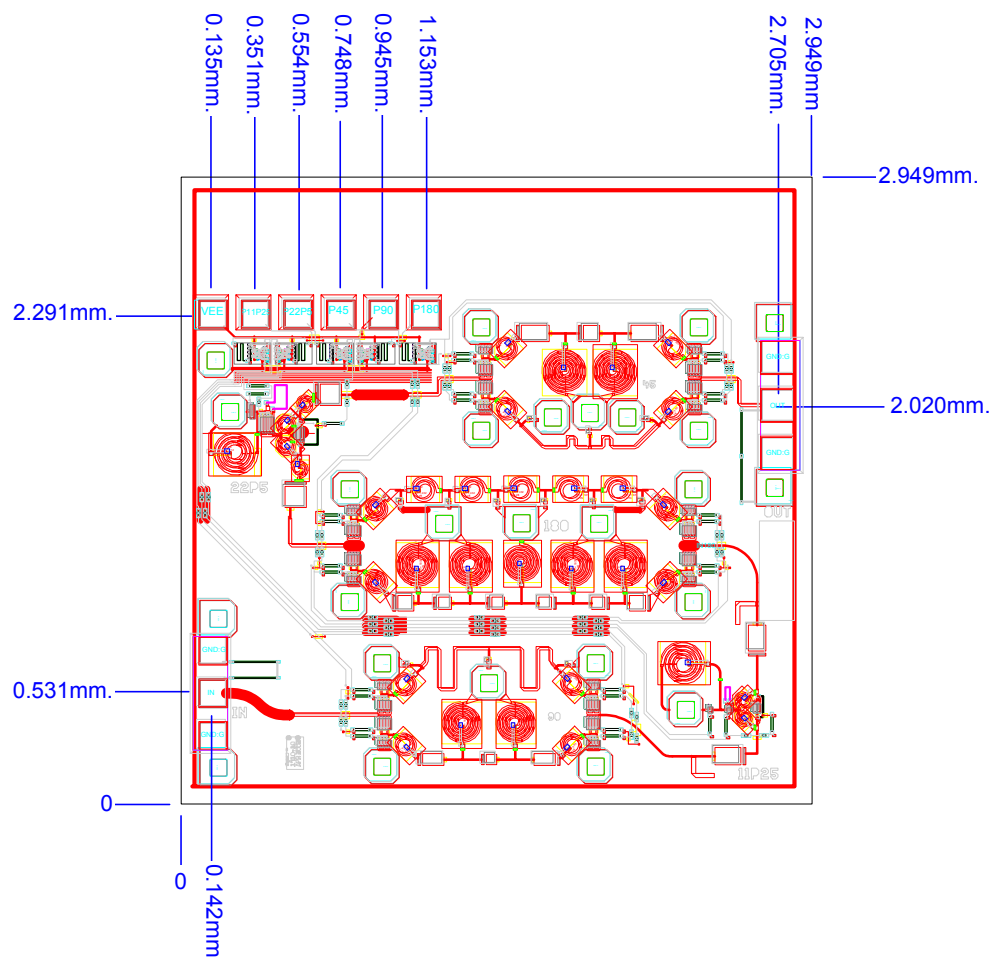

Figure 7. Die Layout

Bond Pad Dimensions

Pad	Size (μm)	Size (mils)
RF In and Out	100 x 200	4 x 8
DC Supply Voltage VEE	125 x 125	5 x 5
DC Control Voltage VC	125 x 125	5 x 5

Specifications subject to change without notice.

Customer Service: Tel. (888)-563-3949

Email: macom_adbu_ics@tycoelectronics.com

- North America: Tel. (800) 366-2266
- Asia/Pacific: Tel. +81-44-844-8296, Fax +81-44-844-8298
- Europe: Tel. +44 (1344) 869 595, Fax+44 (1344) 300 020

tyco / Electronics

MACOM

Visit www.macom.com for additional data sheets and product information.

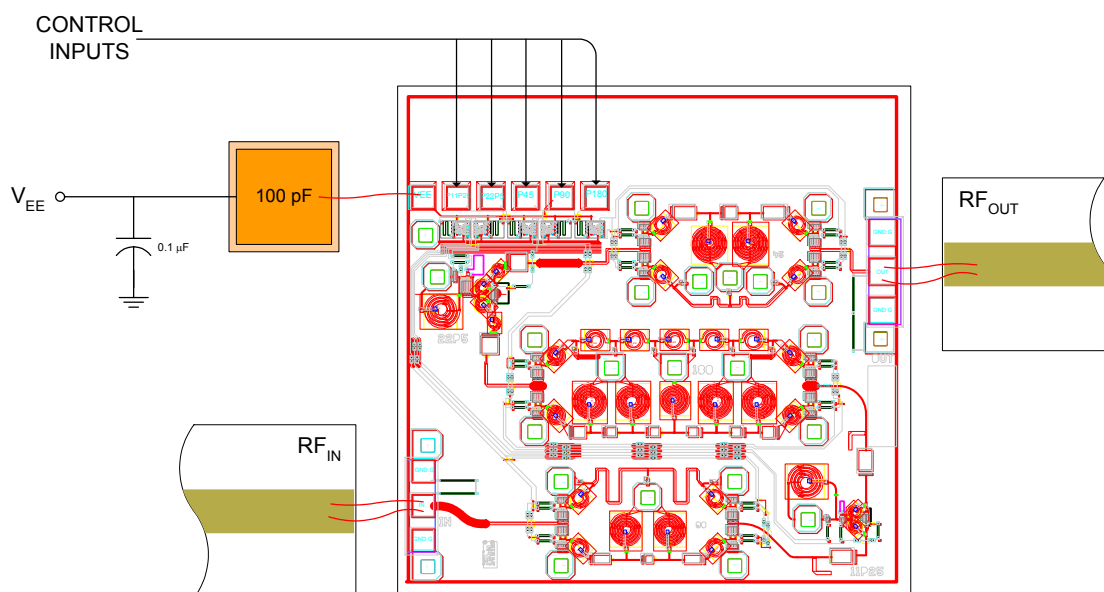

Figure 8. Recommended bonding diagram for pedestal mount.
Support circuitry typical of MMIC characterization.

Assembly Instructions:

Die attach: Low thermal conductivity silver epoxies are acceptable for die attach of this MMIC. Follow the manufacturer's instructions. If solder is employed, use AuSn (80/20) 1-2 mil preform solder. Limit time @ 300 °C to less than 5 minutes.

Wirebonding: Bond @ 160 °C using standard ball or thermal compression wedge bond techniques. For DC and RF pad connections, use either ball or wedge bonds. For best performance, especially above 10 GHz, wedge bonds of shortest length employed on the RF interconnects is preferred over ball bonds.

Biasing Note: Must apply negative bias to V_{EE} before applying positive bias to Control Pads.

Specifications subject to change without notice.

Customer Service: Tel. (888)-563-3949

Email: macom_adbu_ics@tycoelectronics.com

- **North America:** Tel. (800) 366-2266
- **Asia/Pacific:** Tel.+81-44-844-8296, Fax +81-44-844-8298
- **Europe:** Tel. +44 (1344) 869 595, Fax+44 (1344) 300 020

tyco / Electronics

MACOM

Visit www.macom.com for additional data sheets and product information.