

**SPST High Isolation CATV Switch**  
5 – 1000 MHz

MASW-008177  
V1

**Features**

- 75 Ohm Impedance
- Positive Voltage Control (0 / +5 V)
- Input Terminated (Off State)
- Low Insertion Loss: 0.62 dB at 870 MHz
- High Isolation: 54 dB at 870 MHz
- 0.5 micron GaAs PHEMT Process
- Lead-Free 3 mm 12-Lead PQFN Package
- 100% Matte Tin Plating over Copper
- Halogen-Free “Green” Mold Compound
- 260°C Reflow Compatible
- RoHS\* Compliant Version of MASWSS0067

**Description**

M/A-COM's MASW-008177 is a GaAs PHEMT MMIC single pole single throw (SPST) switch in a low cost 3 mm 12-lead PQFN package. The MASW-008177 is ideally suited for applications where low control voltage, low insertion loss, high isolation, small size and low cost are required. Typical applications are to replace mechanical relays in CATV systems. This part can be used in all 75 ohm systems operating up to 1.0 GHz.

The MASW-008177 is fabricated using a 0.5 micron gate length GaAs PHEMT process. The process features full passivation for performance and reliability.

**Ordering Information <sup>1</sup>**

Part Number	Package
MASW-008177-000000	Bulk Packaging
MASW-008177-TR1000	1000 piece reel
MASW-008177-TR3000	3000 piece reel
MASW-008177-001SMB	5-1000 MHz Configuration, Sample Board

1. Reference Application Note M513 for reel size information.

**Functional Schematic**

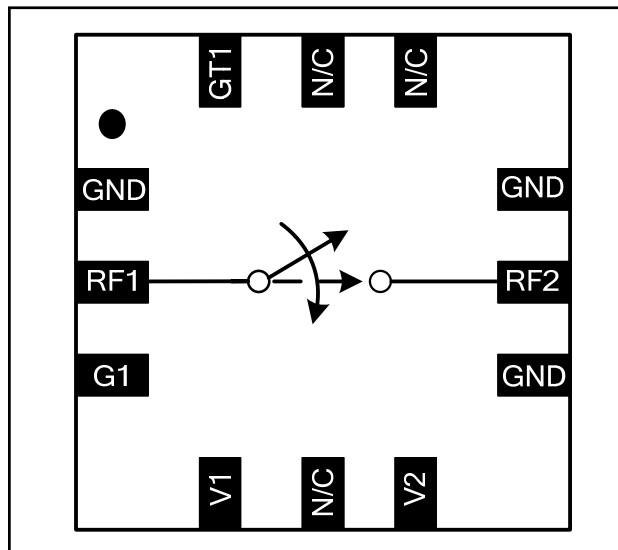

**Pin Configuration <sup>2</sup>**

Pin No.	Pin Name	Description
1	GND	Ground
2	RF1	RF In
3	G1	RF Ground
4	V1	Control 1
5	N/C	No Connection
6	V2	Control 2
7	GND	Ground
8	RF2	RF Out
9	GND	Ground
10	N/C	No Connection
11	N/C	No Connection
12	GT1	RF Ground

2. The exposed pad centered on the package bottom must be connected to both RF and DC ground.

\* Restrictions on Hazardous Substances, European Union Directive 2002/95/EC.

**SPST High Isolation CATV Switch  
5 – 1000 MHz**

**MASW-008177  
V1**

**Electrical Specifications:  $T_A = 25^\circ\text{C}$ ,  $V_C = 0\text{V} / 5\text{V}$ ,  $Z_0 = 75 \Omega$ <sup>3</sup>**

Parameter	Test Conditions	Units	Min.	Typ.	Max.
Insertion Loss	5 - 50 MHz	dB	—	0.45	—
	50 - 1000 MHz	dB	—	0.65	0.9
Isolation	5 - 50 MHz	dB	—	70	—
	50 - 1000 MHz	dB	50	53	—
Return Loss (On)	5 – 50 MHz	dB	—	30	—
	50 – 1000 MHz	dB	—	16	—
Return Loss (Off) (RF1 only)	5 – 50 MHz	dB	—	30	—
	50 – 1000 MHz	dB	—	18	—
IP3	Two Tone, +10 dBm / tone, 6 MHz Spacing, > 50 MHz	dBm	—	52	—
Trise, Tfall	10% to 90% RF, 90% to 10% RF	nS	—	20	—
Ton, Toff	50% control to 90% RF, and 50% control to 10% RF	nS	—	40	—
Transients	In Band	mV	—	30	—
Control Current	Vc  = 5V	μA	—	10	25

3. External DC blocking capacitors are required on all RF ports.

**Absolute Maximum Ratings<sup>4,5</sup>**

Parameter	Absolute Maximum
Input Power (5 - 1000 MHz, 2.5V Control)	+32 dBm
Operating Voltage	+8.5 volts
Operating Temperature	-40 °C to +85 °C
Storage Temperature	-65 °C to +150 °C

4. Exceeding any one or combination of these limits may cause permanent damage to this device.  
5. M/A-COM does not recommend sustained operation near these survivability limits.

**Truth Table<sup>6</sup>**

V1	V2	RF1—RF2
1	0	On
0	1	Off

6. 0 = 0 V +/- 0.2 V; 1 = +2.5 V to +5.0 V.

**Typical Performance Curves**

**Insertion Loss vs. Frequency over Temperature**

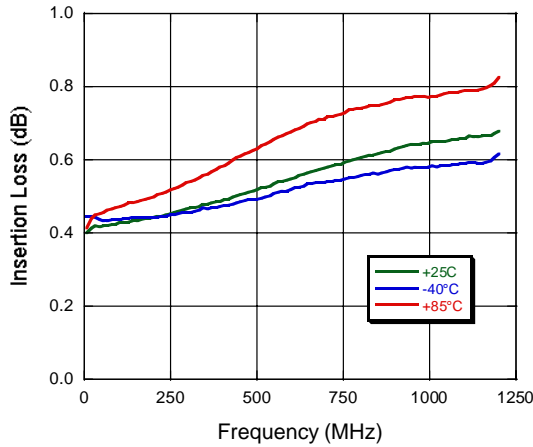

**S11 (Switch On) vs. Frequency over Temperature**

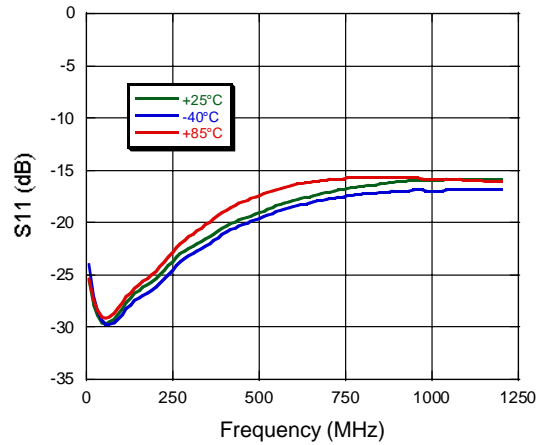

**Isolation vs. Frequency over Temperature**

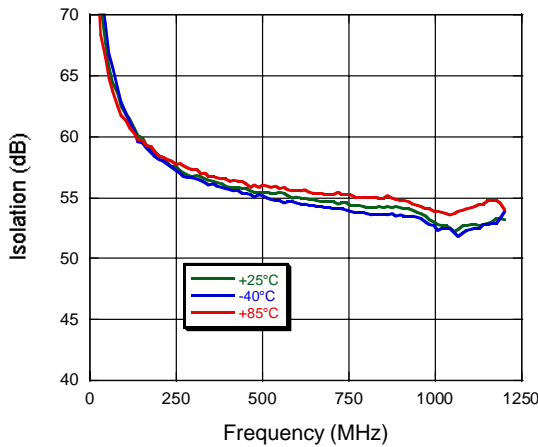

**S11 (Switch Off) vs. Frequency over Temperature**

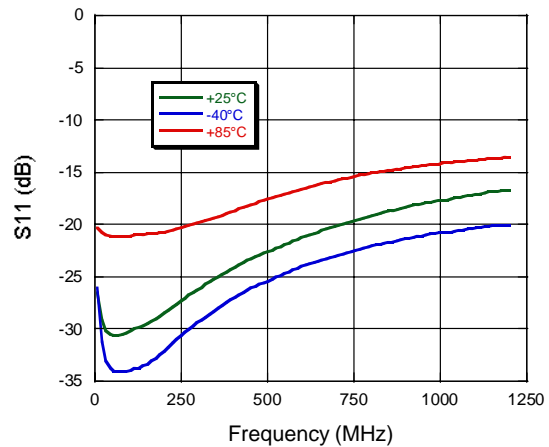

**SPST High Isolation CATV Switch**  
5 – 1000 MHz

MASW-008177  
V1

**Application Schematic**

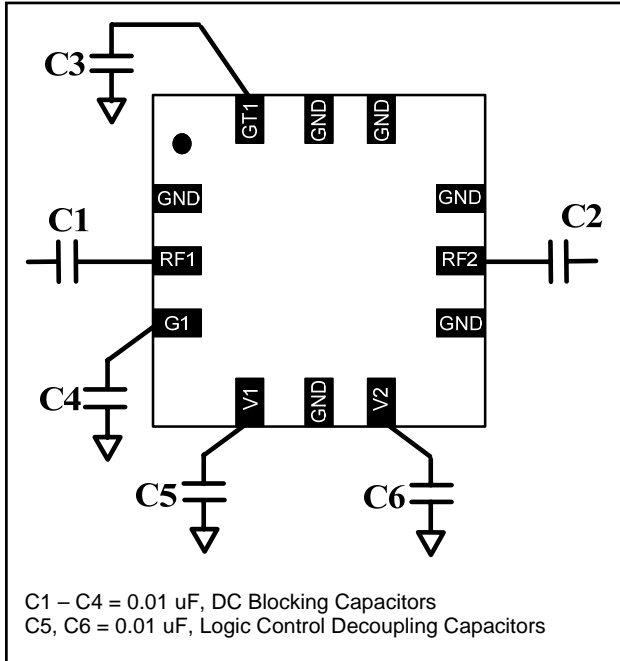

**Qualification**

Qualified to M/A-COM Specification Rel 201, Process Flow -2.

**Handling Procedures**

Please observe the following precautions to avoid damage:

**Static Sensitivity**

Gallium arsenide integrated circuits are sensitive to electrostatic discharge (ESD) and can be damaged by static electricity. Use proper ESD control precautions when handling these devices.

**Lead-Free 3 mm 12-Lead PQFN†**

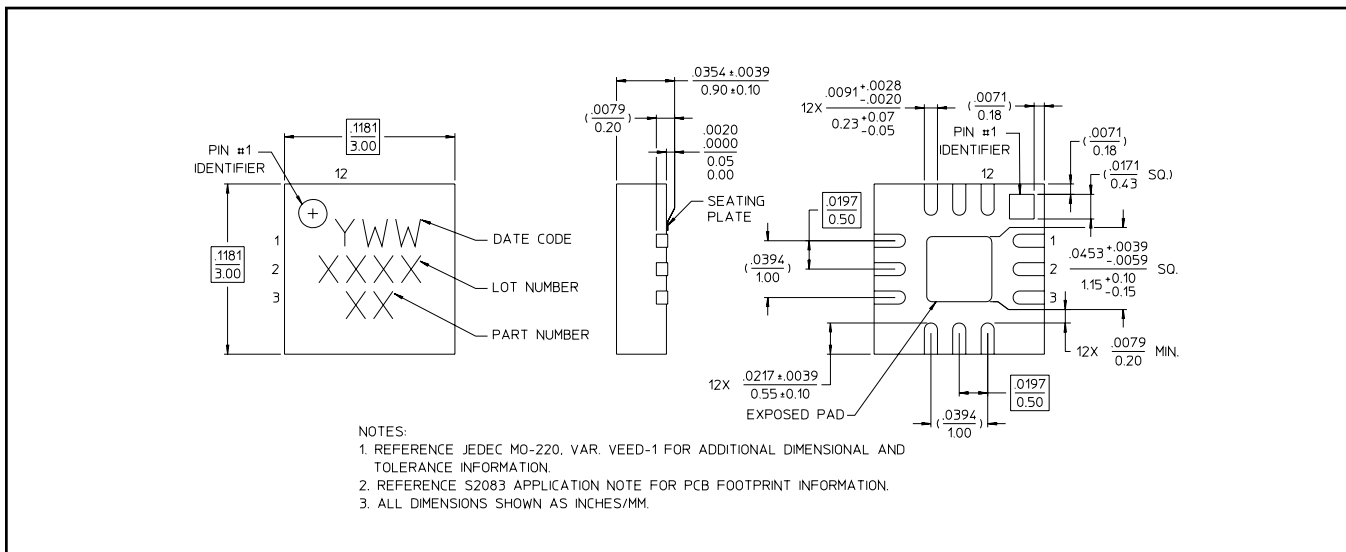

† Reference Application Note M538 for lead-free solder reflow recommendations. Meets JEDEC moisture sensitivity level 1 requirements.