



Single/Dual LVDS Line Receivers with “In-Path” Fail-Safe

MAX9171/MAX9172

General Description

The MAX9171/MAX9172 single/dual low-voltage differential signaling (LVDS) receivers are designed for high-speed applications requiring minimum power consumption, space, and noise. Both devices support switching rates exceeding 500Mbps while operating from a single 3.3V supply.

The MAX9171 is a single LVDS receiver and the MAX9172 is a dual LVDS receiver. Both devices conform to the ANSI TIA/EIA-644 LVDS standard and convert LVDS to LVTTL/LVCMOS-compatible outputs. A fail-safe feature sets the outputs high when the inputs are undriven and open, terminated, or shorted. The MAX9171/MAX9172 are available in 8-pin SO packages and space-saving thin QFN and SOT23 packages.

For lower skew devices, refer to the MAX9111/ MAX9113 data sheet.

Applications

Multipoint Backplane Interconnect
Laser Printers
Digital Copiers
Cellular Phone Base Stations
LCD Displays
Network Switches/Routers
Clock Distribution

Features

- ◆ Input Accepts LVDS and LVPECL
- ◆ In-Path Fail-Safe Circuit
- ◆ Space-Saving 8-Pin QFN and SOT23 Packages
- ◆ Fail-Safe Circuitry Sets Output High for Open, Undriven Shorted, or Undriven Terminated Output
- ◆ Flow-Through Pinout Simplifies PC Board Layout
- ◆ Guaranteed 500Mbps Data Rate
- ◆ Second Source to DS90LV018A and DS90LV028A (SO Packages Only)
- ◆ Conforms to ANSI TIA/EIA-644 Standard
- ◆ 3.3V Supply Voltage
- ◆ -40°C to +85°C Operating Temperature Range
- ◆ Low Power Dissipation

Ordering Information

| PART | TEMP RANGE | PIN-PACKAGE | TOP MARK |
|--------------|----------------|-------------|----------|
| MAX9171EKA-T | -40°C to +85°C | 8 SOT23-8 | AALX |
| MAX9171ESA | -40°C to +85°C | 8 SO | — |
| MAX9171ETA* | -40°C to +85°C | 8 Thin QFN | — |
| MAX9172EKA-T | -40°C to +85°C | 8 SOT23-8 | AALY |
| MAX9172ESA | -40°C to +85°C | 8 SO | — |
| MAX9172ETA* | -40°C to +85°C | 8 Thin QFN | — |

*Future product—contact factory for availability.

Pin Configurations

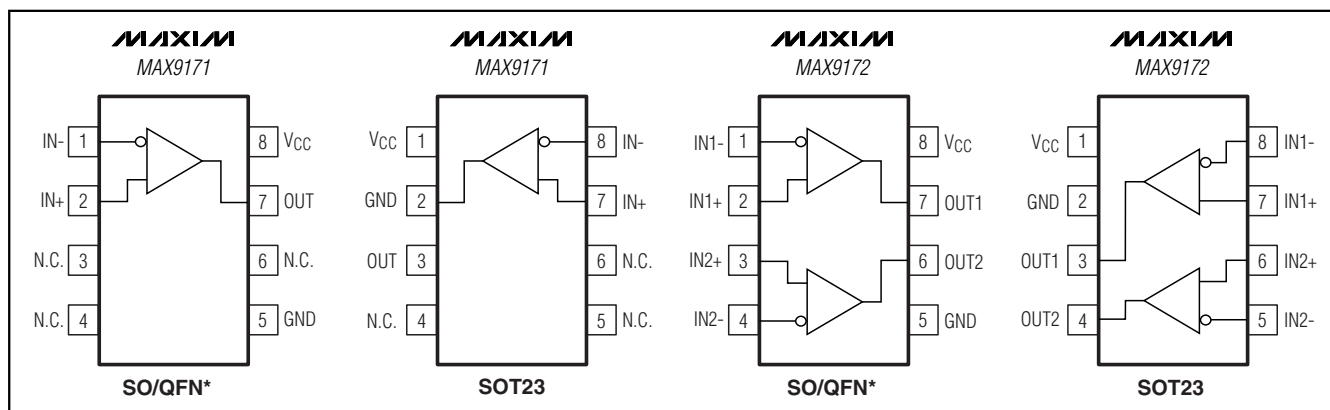

Single/Dual LVDS Line Receivers with “In-Path” Fail-Safe

ABSOLUTE MAXIMUM RATINGS

| | | | |
|---|-----------------------------------|---|-----------------|
| V _{CC} to GND | -0.3V to +4.0V | Operating Temperature Range | -40°C to +85°C |
| IN ₊ , IN ₋ to GND | -0.3V to +4.0V | Junction Temperature | +150°C |
| OUT ₋ to GND | -0.3V to (V _{CC} + 0.3V) | Storage Temperature Range | -65°C to +150°C |
| Continuous Power Dissipation (T _A = +70°C) | | ESD Protection | |
| 8-Pin SOT23 (derate 8.9mW/°C above +70°C) | 714mW | Human Body Model (IN ₊ , IN ₋) | ±13kV |
| 8-Pin SO (derate 5.9mW/°C above +70°C) | 471mW | Lead Temperature (soldering, 10s) | +300°C |
| 8-Pin QFN (derate 24.4mW/°C above +70°C) | 1951mW | | |

Stresses beyond those listed under “Absolute Maximum Ratings” may cause permanent damage to the device. These are stress ratings only, and functional operation of the device at these or any other conditions beyond those indicated in the operational sections of the specifications is not implied. Exposure to absolute maximum rating conditions for extended periods may affect device reliability.

ELECTRICAL CHARACTERISTICS

(V_{CC} = 3.0V to 3.6V, differential input voltage |V_{ID}| = 0.1V to 1.2V, receiver input voltage = 0 to V_{CC}, common-mode voltage V_{CM} = |V_{ID}|/2 to (V_{CC} - |V_{ID}|/2), T_A = -40°C to +85°C, unless otherwise noted. Typical values are at V_{CC} = 3.3V, |V_{ID}| = 0.2V, V_{CM} = 1.2V, T_A = +25°C.) (Notes 1, 2)

| PARAMETER | SYMBOL | CONDITIONS | MIN | TYP | MAX | UNITS |
|---|---------------------|--|----------------------|------|-------|-------|
| LVDS INPUTS (IN₊, IN₋) | | | | | | |
| Differential Input High Threshold | V _{TH} | Figure 1 | | -40 | 0 | mV |
| Differential Input Low Threshold | V _{TL} | Figure 1 | -100 | -40 | | mV |
| Input Current (Noninverting Input) | I _{IN+} | Figure 1 | +0.5 | -2.1 | -5.0 | μA |
| Power-Off Input Current (Noninverting Input) | I _{IN+OFF} | V _{IN+} = 0 to 3.6V, V _{IN-} = 0 to 3.6V, V _{CC} = 0 or open (Figure 1) | -0.5 | 0 | +0.5 | μA |
| Input Current (Inverting Input) | I _{IN-} | Figure 1 | -0.5 | +4.4 | +10.0 | μA |
| Power-Off Input Current (Inverting Input) | I _{IN-OFF} | V _{IN+} = 0 to 3.6V, V _{IN-} = 0 to 3.6V, V _{CC} = 0 or open (Figure 1) | -0.5 | 0 | +0.5 | μA |
| LVCMOS/LVTTL OUTPUTS (OUT₋) | | | | | | |
| Output High Voltage | V _{OH} | I _{OH} = -4.0mA Open, undriven short, or undriven parallel termination | | 2.7 | 3.2 | V |
| | | | V _{ID} = 0V | 2.7 | 3.2 | |
| Output Low Voltage | V _{OL} | I _{OL} = 4.0mA, V _{ID} = -100mV | | 0.1 | 0.4 | V |
| Output Short-Circuit Current | I _{OS} | V _{OUT-} = 0 (Note 3) | -45 | -77 | -120 | mA |
| POWER SUPPLY | | | | | | |
| Supply Current | I _{CC} | Inputs open | MAX9171 | 3.6 | 6 | mA |
| | | | MAX9172 | 7.0 | 9 | |

Single/Dual LVDS Line Receivers with “In-Path” Fail-Safe

MAX9171/MAX9172

SWITCHING CHARACTERISTICS

($V_{CC} = 3.0V$ to $3.6V$, $C_L = 15pF$, $|V_{ID}| = 0.2V$, $V_{CM} = 1.2V$, $T_A = -40^{\circ}C$ to $+85^{\circ}C$, unless otherwise noted. Typical values are at $V_{CC} = 3.3V$, $T_A = +25^{\circ}C$.) (Notes 4, 5, 6)

| PARAMETER | SYMBOL | CONDITIONS | MIN | TYP | MAX | UNITS |
|---|------------|--|-----|------|-----|-------|
| Differential Propagation Delay High to Low | t_{PHLD} | Figures 2, 3 | 1.0 | 1.65 | 2.5 | ns |
| Differential Propagation Delay Low to High | t_{PLHD} | Figures 2, 3 | 1.0 | 1.62 | 2.5 | ns |
| Differential Pulse Skew $ t_{PHLD} - t_{PLHD} $ | t_{SKD1} | Figures 2, 3 (Note 7) | | 30 | 400 | ps |
| Differential Channel-to-Channel Skew (MAX9172) | t_{SKD2} | Figures 2, 3 (Note 8) | | 40 | 500 | ps |
| Differential Part-to-Part Skew | t_{SKD3} | Figures 2, 3 (Note 9) | | | 1 | ns |
| | t_{SKD4} | Figures 2, 3 (Note 10) | | | 1.5 | |
| Rise Time | t_{TLH} | Figures 2, 3 | | 0.55 | 0.8 | ns |
| Fall Time | t_{THL} | Figures 2, 3 | | 0.51 | 0.8 | ps |
| Maximum Operating Frequency | f_{MAX} | All channels switching, $V_{OL(MAX)} = 0.4V$, $V_{OH(MIN)} = 2.7V$, 40% < duty cycle < 60% | 250 | 300 | | MHz |

Note 1: Current into a pin is defined as positive. Current out of a pin is defined as negative. All voltages are referenced to GND except V_{TH} , V_{TL} , and V_{ID} .

Note 2: All devices are 100% production tested at $T_A = +25^{\circ}C$ and are guaranteed by design for $T_A = -40^{\circ}C$ to $+85^{\circ}C$, as specified.

Note 3: Short only one output at a time. Do not exceed the absolute maximum junction temperature specification.

Note 4: AC parameters are guaranteed by design and not production tested.

Note 5: C_L includes scope probe and test jig capacitance.

Note 6: Pulse generator output conditions: $t_R = t_F < 1ns$ (0% to 100%), frequency = 250MHz, 50% duty cycle, $V_{OH} = 1.3V$, $V_{OL} = 1.1V$.

Note 7: t_{SKD1} is the magnitude of the difference of differential propagation delays in a channel. $t_{SKD1} = |t_{PHLD} - t_{PLHD}|$.

Note 8: t_{SKD2} is the magnitude of the difference of the t_{PLHD} or t_{PHLD} of one channel and the t_{PLHD} or t_{PHLD} of the other channel on the same part.

Note 9: t_{SKD3} is the magnitude of the difference of any differential propagation delays between parts at the same V_{CC} and within $5^{\circ}C$ of each other.

Note 10: t_{SKD4} is the magnitude of the difference of any differential propagation delays between parts operating over the rated supply and temperature ranges.

Single/Dual LVDS Line Receivers with "In-Path" Fail-Safe

Typical Operating Characteristics

($V_{CC} = 3.3V$, $V_{CM} = 1.2V$, $|V_{ID}| = 0.2V$, $f_{IN} = 200MHz$, $C_L = 15pF$, $T_A = +25^\circ C$, unless otherwise specified.)

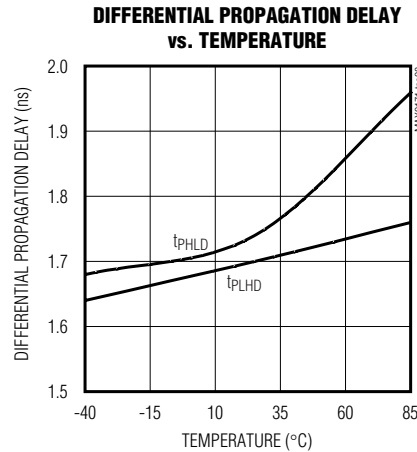
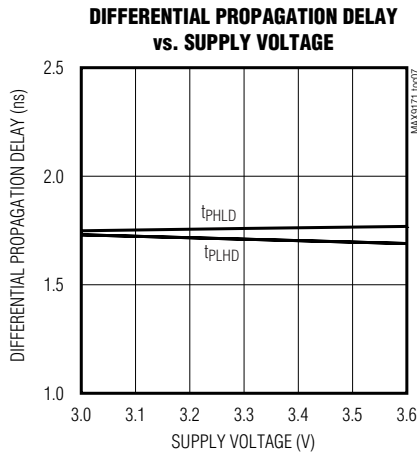
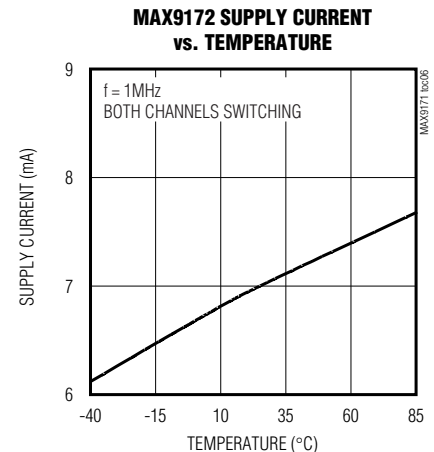
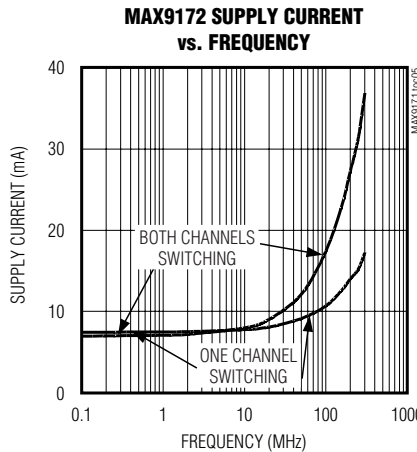
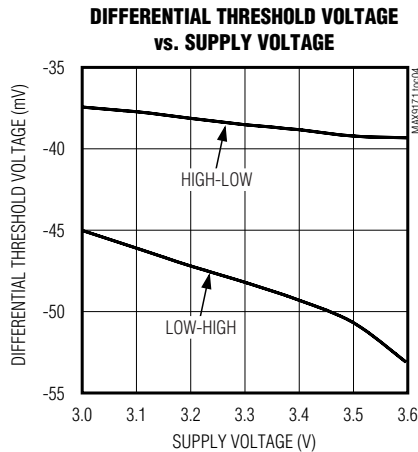
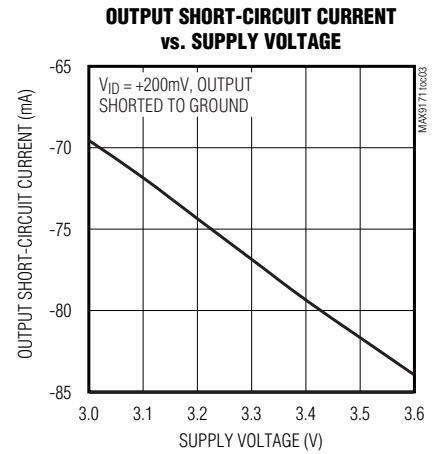
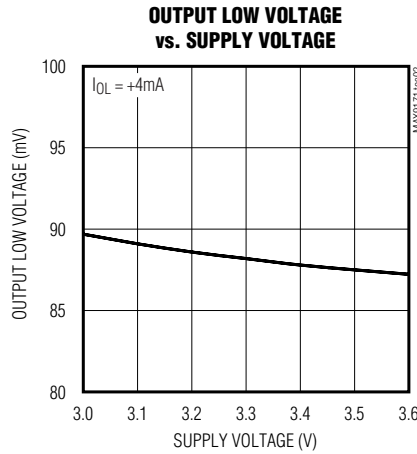
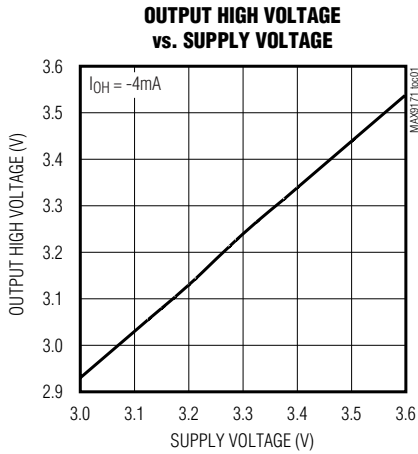

Single/Dual LVDS Line Receivers with “In-Path” Fail-Safe

Typical Operating Characteristics (continued)

($V_{CC} = 3.3V$, $V_{CM} = 1.2V$, $|V_{ID}| = 0.2V$, $f_{IN} = 200MHz$, $C_L = 15pF$, $T_A = +25^\circ C$, unless otherwise specified.)

MAX9171/MAX9172

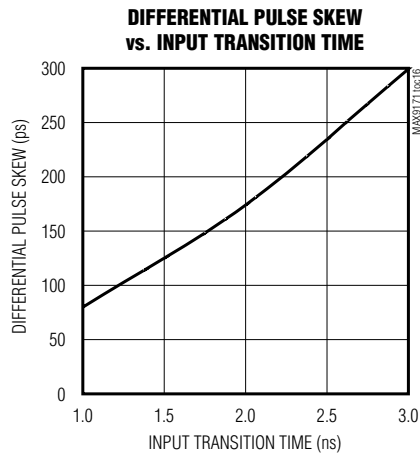
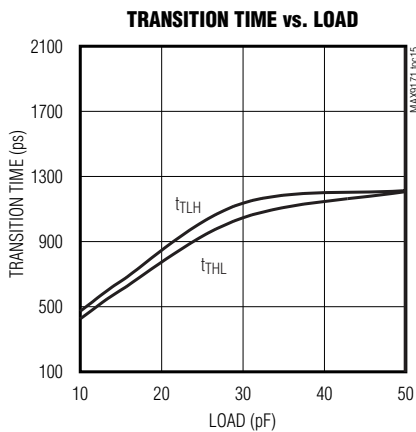
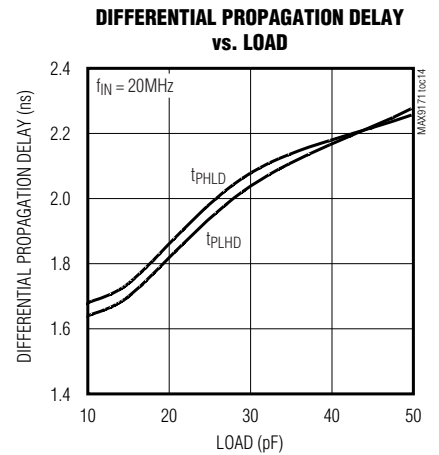
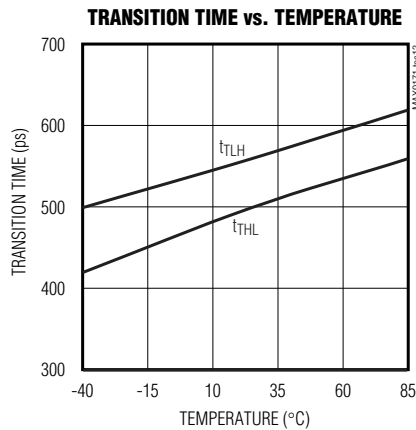
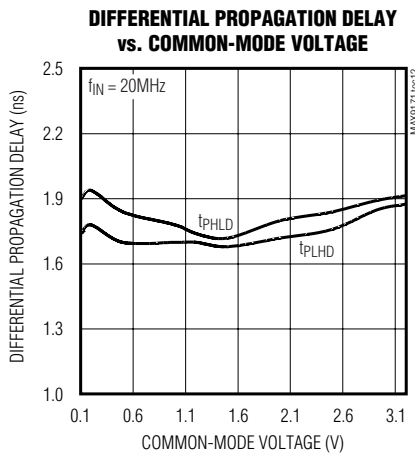
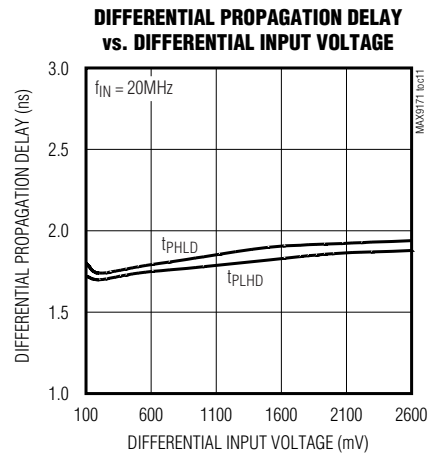
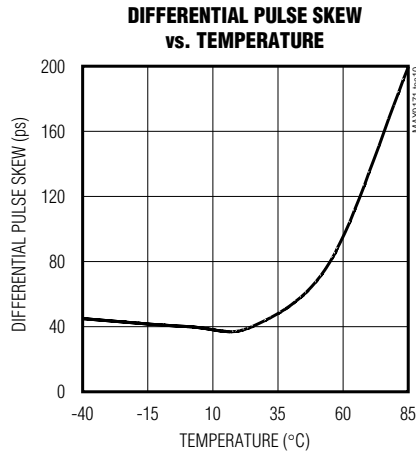
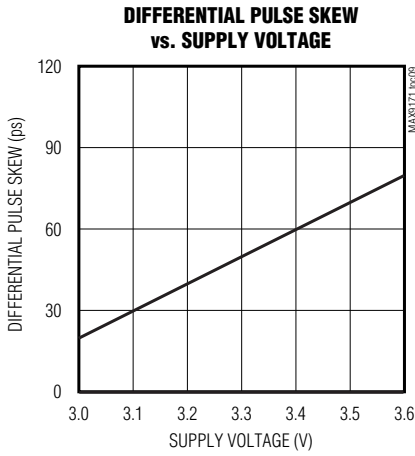

Single/Dual LVDS Line Receivers with “In-Path” Fail-Safe

MAX9171 Pin Description

| PIN | | NAME | FUNCTION |
|---------|------------|-----------------|---|
| SOT23 | SO/QFN | | |
| 1 | 8 | V _{CC} | Positive Power-Supply Input. Bypass with a 0.1μF and a 0.001μF capacitor to GND with the smallest capacitor closest to the pin. |
| 2 | 5 | GND | Ground |
| 3 | 7 | OUT | Receiver Output |
| 4, 5, 6 | 3, 4, 6 | N.C. | No Connection. Not internally connected. |
| 7 | 2 | IN+ | Noninverting Differential Receiver Input |
| 8 | 1 | IN- | Inverting Differential Receiver Input |
| — | (QFN only) | EP | Exposed Paddle. Solder to PC board ground. |

MAX9172 Pin Description

| PIN | | NAME | FUNCTION |
|-------|------------|-----------------|---|
| SOT23 | SO/QFN | | |
| 1 | 8 | V _{CC} | Positive Power-Supply Input. Bypass with a 0.1μF and a 0.001μF capacitor to GND with the smallest capacitor closest to the pin. |
| 2 | 5 | GND | Ground |
| 3 | 7 | OUT1 | Receiver Output 1 |
| 4 | 6 | OUT2 | Receiver Output 2 |
| 5 | 4 | IN2- | Inverting Differential Receiver Input 2 |
| 6 | 3 | IN2+ | Noninverting Differential Receiver Input 2 |
| 7 | 2 | IN1+ | Noninverting Differential Receiver Input 1 |
| 8 | 1 | IN1- | Inverting Differential Receiver Input 1 |
| — | (QFN only) | EP | Exposed Paddle. Solder to PC board ground. |

Detailed Description

LVDS Inputs

The MAX9171/MAX9172 feature LVDS inputs for interfacing high-speed digital circuitry. The LVDS interface standard is a signaling method intended for point-to-point communication over controlled-impedance media, as defined by the ANSI TIA/EIA-644 standards. The technology uses low-voltage signals to achieve fast transition times and minimize power dissipation and noise immunity. The MAX9171/MAX9172 convert LVDS

signals to LVCMOS/LVTTL signals at rates in excess of 500Mbps. These devices are capable of detecting differential signals as low as 100mV and as high as 1.2V within a 0 to V_{CC} input voltage range. Table 1 is the input-output function table.

Fail-Safe

The MAX9171/MAX9172 fail-safe drives the receiver output high when the differential input is:

- Open
- Undriven and shorted
- Undriven and terminated

Without fail-safe, differential noise at the input may switch the receiver and appear as data to the receiving system. An open input occurs when a cable and termination are disconnected. An undriven, terminated input occurs when a cable is disconnected with the termination still connected across the receiver inputs or when the driver of a receiver is in high impedance. An undriven, shorted input can occur due to a shorted cable.

Table 1. Input-Output Function Table

| INPUTS | OUTPUT |
|---|------------------|
| (IN ₊) - (IN ₋) | OUT ₋ |
| ≥ 0mV | High |
| ≤ -100mV | Low |
| Open | High |
| Undriven short | High |
| Undriven parallel termination | High |

Single/Dual LVDS Line Receivers with “In-Path” Fail-Safe

MAX9171/MAX9172

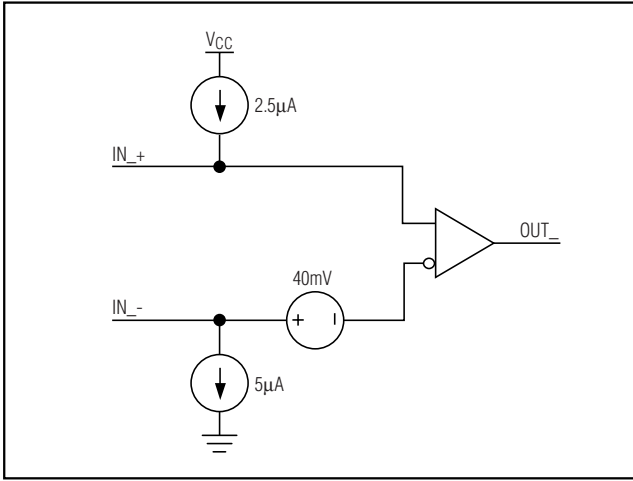

Figure 1. Input with In-Path Fail-Safe Network Equivalent Circuit

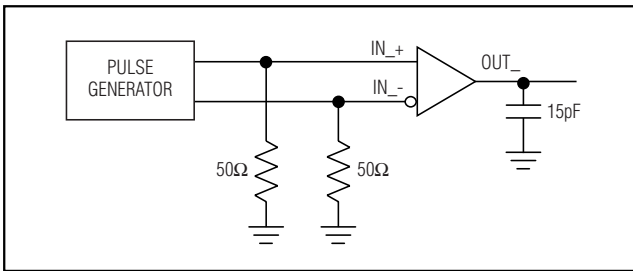

Figure 2. Propagation Delay and Transition Test Time Circuit

In-Path vs. Parallel Fail-Safe

The MAX9171/MAX9172 have in-path fail-safe that is compatible with in-path fail-safe receivers, such as the DS90LV018A and DS90LV028A. Refer to the MAX9111/MAX9113 data sheet for pin-compatible receivers with parallel fail-safe and lower jitter. Refer to the MAX9130 data sheet for a single LVDS receiver with parallel fail-safe in an SC70 package.

The MAX9171/MAX9172 with in-path fail-safe are designed with a +40mV input offset voltage, a 2.5µA current source between VCC and the noninverting input, and a 5µA current sink between the inverting input and ground (Figure 1). If the differential input is open, the 2.5µA current source pulls the input to VCC - 0.7V and the 5µA source sink pulls the inverting input to ground, which drives the receiver output high. If the differential input is shorted or terminated with a typical value termination resistor, the +40mV offset drives the receiver output high. If the input is terminated and floating, the receiver output is driven high by the +40mV offset, and the 2:1 current sink to current source ratio (5µA:2.5µA) pulls the inputs to ground. This can be an advantage when switching between drivers on a multi-point bus because the change in common-mode voltage from ground to the typical driver offset voltage of 1.2V is not as much as the change from VCC to 1.2V (parallel fail-safe pulls the bus to VCC). Figure 2 shows the propagation delay and transition test time circuit and Figure 3 shows the propagation delay and transition test time waveforms.

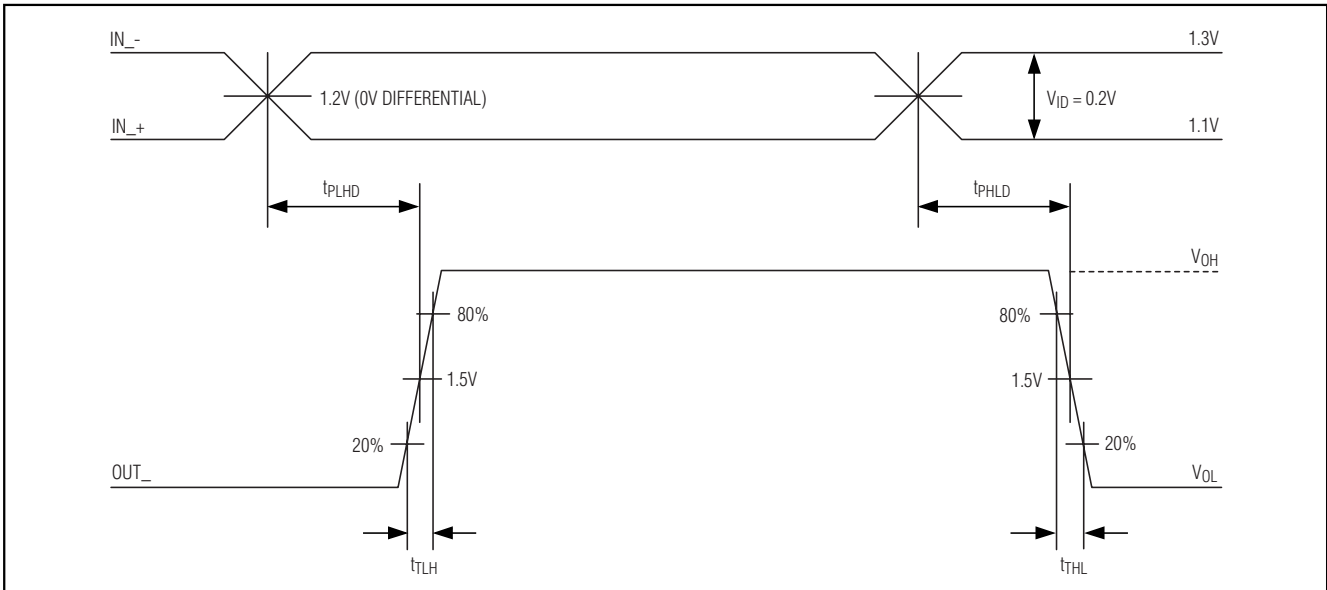

Figure 3. Propagation Delay and Transition Time Waveforms

Single/Dual LVDS Line Receivers with “In-Path” Fail-Safe

ESD Protection

ESD protection structures are incorporated on all pins to protect against electrostatic discharges encountered during handling and assembly. The receiver inputs of the MAX9171/MAX9172 have extra protection against static electricity. These pins are protected to $\pm 13\text{kV}$ without damage. The structures withstand ESD during normal operation and when powered down.

The receiver inputs of these devices are characterized for protection to the limit of $\pm 13\text{kV}$ using the Human Body Model.

Human Body Model

Figure 4a shows the Human Body Model, and Figure 4b shows the current waveform it generates when discharged into a low-impedance load. This model consists of a 100pF capacitor charged to the ESD test voltage, which is then discharged into the test device through a $1.5\text{k}\Omega$ resistor.

Applications Information

Supply Bypassing

Bypass V_{CC} with high-frequency surface-mount ceramic $0.1\mu\text{F}$ and $0.001\mu\text{F}$ capacitors in parallel, as close to the device as possible, with the $0.001\mu\text{F}$ capacitor closest to the device. For additional supply bypassing, place a $10\mu\text{F}$ tantalum or ceramic capacitor at the point where power enters the circuit board.

Differential Traces

Input trace characteristics affect the performance of the MAX9171/MAX9172. Use controlled-impedance PC board traces to match the cable characteristic impedance.

Eliminate reflections and ensure that noise couples as common mode by running the differential traces close together. Reduce skew by matching the electrical length of traces.

Each channel's differential signals should be routed close to each other to cancel their external magnetic field. Maintain a constant distance between the differential traces to avoid discontinuities in differential impedance. Avoid 90° turns and minimize the number of vias to further prevent impedance discontinuities.

Cables and Connectors

Transmission media typically have a controlled differential impedance of about 100Ω . Use cables and connectors that have matched differential impedance to minimize impedance discontinuities. Balanced cables tend to pick up noise as common mode, which is rejected by the LVDS receiver.

Termination

The MAX9171/MAX9172 require an external termination resistor. The termination resistor should match the differential impedance of the transmission line. Termination resistance values may range between 90Ω to 132Ω , depending on the characteristic impedance of the transmission medium.

When using the MAX9171/MAX9172, minimize the distance between the input termination resistors and the MAX9171/MAX9172 receiver inputs. Use a single 1% surface-mount resistor.

Board Layout

For LVDS applications, a four-layer PC board that provides separate power, ground, LVDS signals, and output signals is recommended. Separate the input LVDS signals from the output signals to prevent crosstalk. Solder the exposed pad on the QFN package to a pad connected to the PC board ground plane by a matrix of vias. Connecting the exposed pad is not a substitute for connecting the ground pin. Always connect pin 5 on the QFN package to ground.

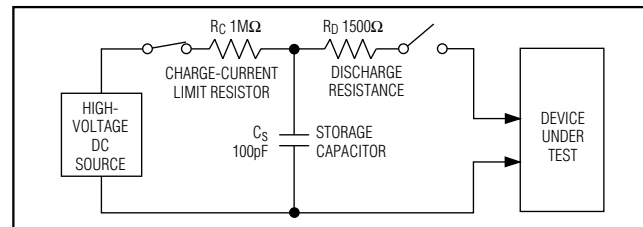

Figure 4a. Human Body ESD Test Modules

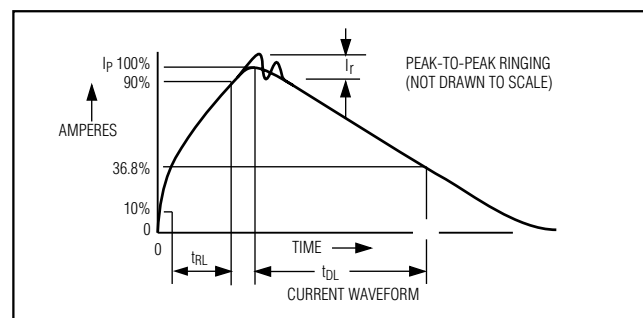

Figure 4b. Human Body Current Waveform

Chip Information

TRANSISTOR COUNT: 624

PROCESS: CMOS

Single/Dual LVDS Line Receivers with “In-Path” Fail-Safe

Package Information

(The package drawing(s) in this data sheet may not reflect the most current specifications. For the latest package outline information, go to www.maxim-ic.com/packages.)

MAX9171/MAX9172

SOT23, 8LEPS

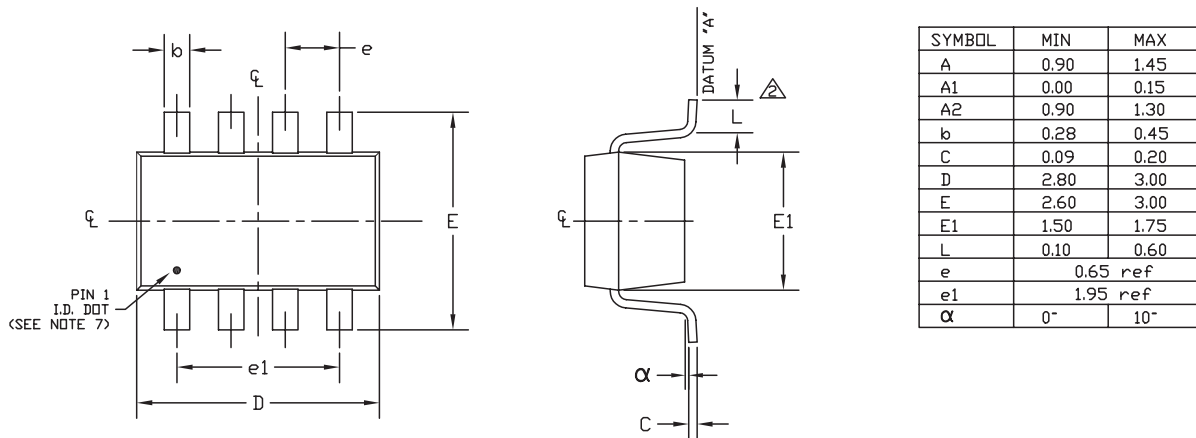

NOTE:

1. ALL DIMENSIONS ARE IN MILLIMETERS.
2. FOOT LENGTH MEASURED REFERENCE TO FLAT FOOT SURFACE PARALLEL TO DATUM "A".
3. PACKAGE OUTLINE EXCLUSIVE OF MOLD FLASH & METAL BURR.
4. PACKAGE OUTLINE INCLUSIVE OF SOLDER PLATING.
5. EIAJ REF. NUMBER SC-74 (6 LEAD VERSION)
6. COPLANARITY 4 MILS. MAX.
7. PIN 1 I.D. DOT IS 0.3 MM Ø MIN. LOCATED ABOVE PIN 1.
8. MEETS JEDEC MO178.

MAXIM

PROPRIETARY INFORMATION

TITLE:
PACKAGE OUTLINE, SOT-23, 8L

| | | | |
|----------|---------------------------------|----------|-----|
| APPROVAL | DOCUMENT CONTROL NO. 21-0078 | REV C | 1/1 |
|----------|---------------------------------|----------|-----|

Single/Dual LVDS Line Receivers with "In-Path" Fail-Safe

Package Information (continued)

(The package drawing(s) in this data sheet may not reflect the most current specifications. For the latest package outline information, go to www.maxim-ic.com/packages.)

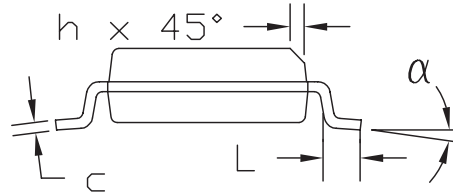
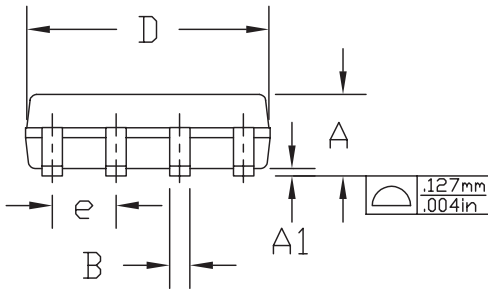
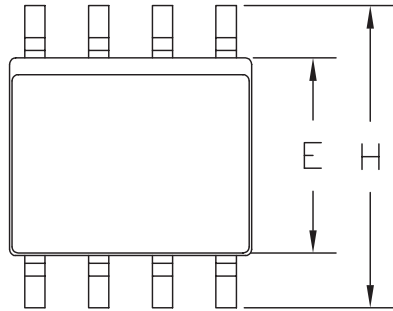

| DIM | INCHES | | MILLIMETERS | |
|-----|--------|-------|-------------|------|
| | MIN | MAX | MIN | MAX |
| A | 0.053 | 0.069 | 1.35 | 1.75 |
| A1 | 0.004 | 0.010 | 0.10 | 0.25 |
| B | 0.014 | 0.019 | 0.35 | 0.49 |
| C | 0.007 | 0.010 | 0.19 | 0.25 |
| D | 0.189 | 0.197 | 4.80 | 5.00 |
| e | 0.050 | BSC | 1.27 | BSC |
| E | 0.150 | 0.157 | 3.80 | 4.00 |
| H | 0.228 | 0.244 | 5.80 | 6.20 |
| h | 0.010 | 0.020 | 0.25 | 0.50 |
| L | 0.016 | 0.050 | 0.40 | 1.27 |
| α | 0? | 8? | 0? | 8? |

NOTES:

1. D&E DO NOT INCLUDE MOLD FLASH.
2. MOLD FLASH OR PROTRUSIONS NOT TO EXCEED .15mm (.006")
3. CONTROLLING DIMENSION: MILLIMETER
4. MEETS JEDEC MS-012 AA.

| | | | |
|-------------------------|---------|-----|-----|
| MAXIM | | | |
| PROPRIETARY INFORMATION | | | |
| TITLE | | | |
| 8L SOIC OUTLINE | | | |
| APPROVAL | DWG | REV | 1/1 |
| | 21-0325 | A | |

9LUCSP_3x3.EPS

Single/Dual LVDS Line Receivers with “In-Path” Fail-Safe

Package Information (continued)

(The package drawing(s) in this data sheet may not reflect the most current specifications. For the latest package outline information, go to www.maxim-ic.com/packages.)

MAX9171/MAX9172

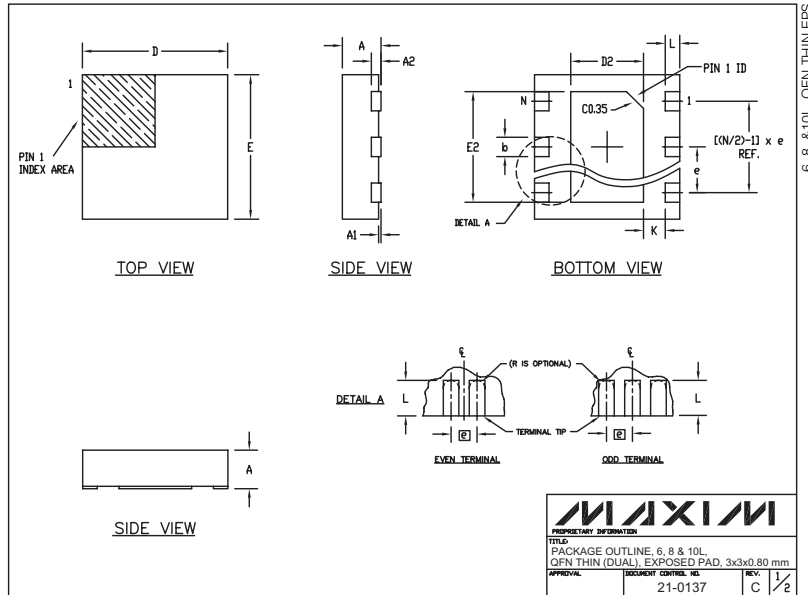

| COMMON DIMENSIONS | | | | | | | |
|-------------------|-----------|------|--|--|--|--|--|
| SYMBOL | MIN. | MAX. | | | | | |
| A | 0.70 | 0.80 | | | | | |
| D | 2.90 | 3.10 | | | | | |
| E | 2.90 | 3.10 | | | | | |
| A1 | 0.00 | 0.05 | | | | | |
| L | 0.20 | 0.40 | | | | | |
| k | 0.25 MIN | | | | | | |
| A2 | 0.20 REF. | | | | | | |

| PACKAGE VARIATIONS | | | | | | | |
|--------------------|----|-----------|-----------|----------|----------------|-----------|---------------|
| PKG. CODE | N | D2 | E2 | e | JEDEC SPEC | b | [(N/2)-1] x e |
| T633-1 | 6 | 1.50-0.10 | 2.30-0.10 | 0.95 BSC | MO229 / WEEA | 0.40-0.05 | 1.90 REF |
| T833-1 | 8 | 1.50-0.10 | 2.30-0.10 | 0.65 BSC | MO229 / WEEC | 0.30-0.05 | 1.95 REF |
| T1033-1 | 10 | 1.50-0.10 | 2.30-0.10 | 0.50 BSC | MO229 / WEED-3 | 0.25-0.05 | 2.00 REF |

NOTES:

1. ALL DIMENSIONS ARE IN mm, ANGLES IN DEGREES.
2. COPLANARITY SHALL NOT EXCEED 0.08 mm.
3. WARPAGE SHALL NOT EXCEED 0.10 mm.
4. PACKAGE LENGTH/PACKAGE WIDTH ARE CONSIDERED AS SPECIAL CHARACTERISTIC(S).
5. DRAWING CONFORMS TO JEDEC MO220.

| | |
|--|---|
| MAXIM | |
| PROPRIETARY INFORMATION | |
| TITLE: PACKAGE OUTLINE, 6, 8 & 10L QFN THIN (DUAL), EXPOSED PAD, 3x3x0.80 mm | |
| APPROVAL: | DOCUMENT CONTROL NO: 21-0137 REV: C 2/2 |

Maxim cannot assume responsibility for use of any circuitry other than circuitry entirely embodied in a Maxim product. No circuit patent licenses are implied. Maxim reserves the right to change the circuitry and specifications without notice at any time.

Maxim Integrated Products, 120 San Gabriel Drive, Sunnyvale, CA 94086 408-737-7600 _____ 11