

# Remaining Battery Power Display Monolithic IC MM1210 Series

## Outline

This IC detects battery voltage and displays the remaining power in the battery using an LCD. Long life and light weight are emphasized in the most recent portable equipment, which increasingly use nickel cadmium and nickel hydrogen batteries. For these batteries, the discharge characteristics mean that extremely precise detection of the remaining battery power is required.

This IC enables detection of this type through high precision voltage detection.

## Features

1. Two built-in detection voltages            1.18V / 1.06V typ.
2. High precision detection voltages        ±1% typ.
3. Low current consumption                    During detection ; 15 µA typ.  
    During waiting ; 15 µA typ.
4. Setting possible during non-induction  
    It is possible to set a time period for which detection is ignored, as for example when voltage drops due to temporary heavy loads.
5. Ripple absorption pins  
    It is possible to check fluctuations in detection through continuous rippling.
6. Built-in hysteresis voltage

## Package

SOP-8D (MM1210XF)

## Absolute Maximum Ratings

Item	Rating
Storage temperature	-40~+125°C
Operating temperature	-20~+70°C
Input voltage	5V
Output pin voltage	5V
Allowable loss	300mW

**Electrical Characteristics** (Unless otherwise specified Ta=25°C, VCC=1.5V, VCE=VCC)

Item	Symbol	Measurement Conditions	Min.	Typ.	Max.	Unit	
Current consumption	Icc1	VCC=1.5V		15	25	μA	
Current consumption during waiting	Icc2	VCC=1.3V, VCE=0.3V		1.5	2.5	μA	
Detection voltage I	VTH1	VCC=H→L	1.169	1.180	1.191	V	
Detection voltage II	VTH2	VCC=H→L	1.050	1.060	1.070	V	
Detection voltage Difference	ΔVT	ΔVT=VTH1-VTH2	100	120	140	mV	
Detection voltage temperature factor				±200		PPM/°C	
Hysteresis voltage	VHYS		10	20	35	mV	
Output sink current I	Is1	VCC=1.3V, Vo1=0.3V	40			μA	
Output sink current II	Is2	VCC=1.3V, Vo2=0.3V	40			μA	
Output saturation voltage I	Vo1	ISINK=30UA		150	250	mV	
Output saturation voltage II	Vo2	ISINK=30UA		150	250	mV	
Output leak voltage I	Ile1	VCC=1.0V, Vo1=0.5V			1	μA	
Output leak voltage II	Ile2	VCC=1.0V, Vo2=1.5V			1	μA	
Power supply voltage operating limit	VOPL	VCC=variable, Vo < 0.4V		0.70	0.75	V	
CE pin	Input H voltage	VCEH	-0.3	VCC	0.3	V	
	Input L current	ICEH	100	300	500	nA	
	Input L voltage	VCEL	-0.3	0	0.3	V	
TC pin	Threshold value I	VTHT	0.34	0.42	0.50	V	
	Threshold value II	VTHT	0.04	0.12	0.20	V	
	Discharge current	IDIS	30	60	90	nA	
	Charge current	ICHA	0.40	0.80	1.20	μA	
Non-induction time	td	VCC=1.5V, C=0.033UF	120	180	240	mS	
L transmission delay time	tdLH	VCC=L→H, C=0.033UF	1.0	2.0	4.0	mS	
Ripple absorption resistance	RRIP	measure resistance between pins 8-6	70	100	130	kΩ	
Note : Vcc applied pulse conditions					td1	td2	
			1.25V	1.15V			
			GND	1.10V	1.00V		

Timing Chart

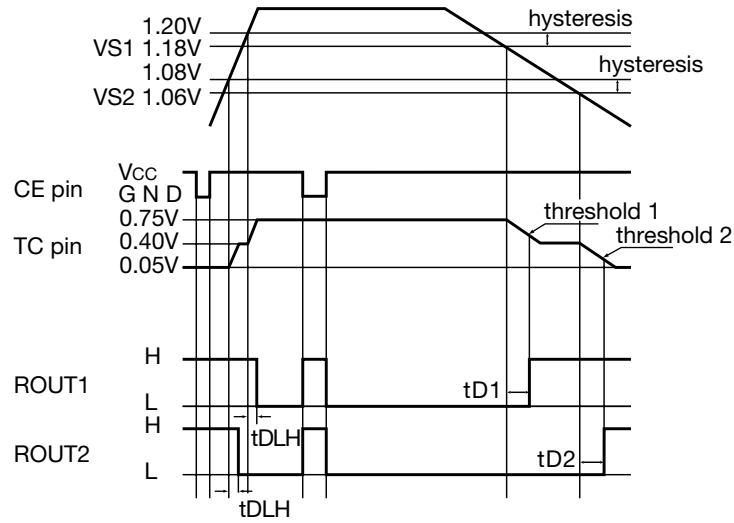

\*Delay time is calculated by the following formula :  
 $tD1=tD2 (S)=C_T (F) \times (5.4 \times 10^6)$   
 $tDLH (S)=C_T (F) \times (6.3 \times 10^4)$   
 $C_T$ , TC pin connection capacitance

Block Diagram, Example of Application Circuit

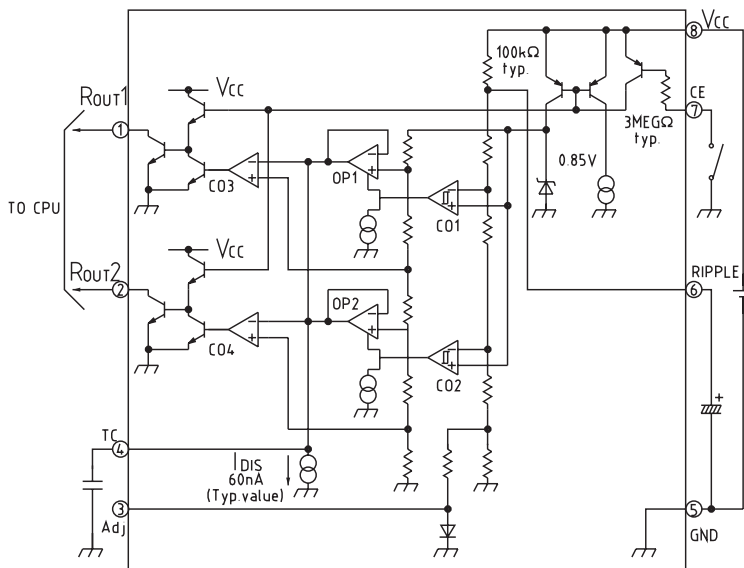

Output

Vcc	1.18	1.06
ROUT 1	L	H
LED 2	L	H

CE pin

H	Operation
L	Waiting

Note 1 : Please connect the CE pin to Vcc when not using.

Note 2 : The Adj terminal is used in the product inspection process, so please do not connect it to other wiring.

Capacitance of external capacitor for non-induction time

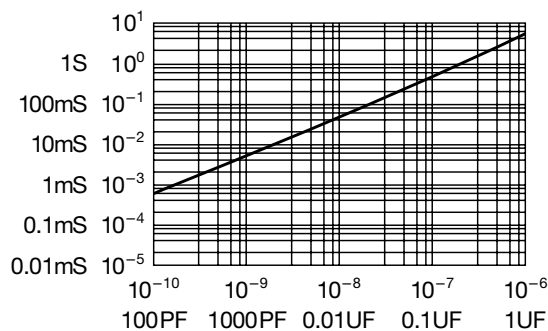

Characteristics

■ Detection voltage 1  
Temperature characteristics

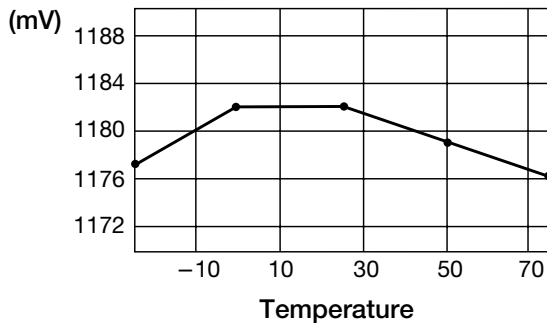

■ Detection voltage 2  
Temperature characteristics

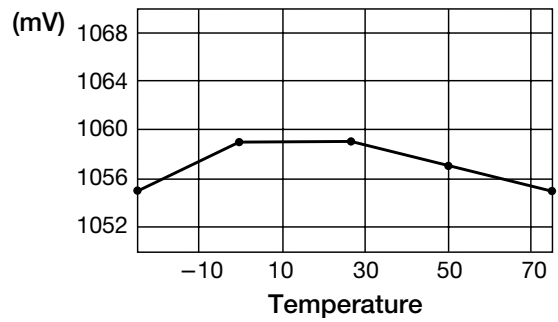

■ Hysteresis voltage 1  
Temperature characteristics

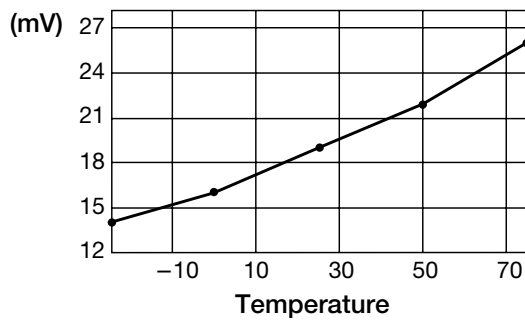

■ Hysteresis voltage 2  
Temperature characteristics

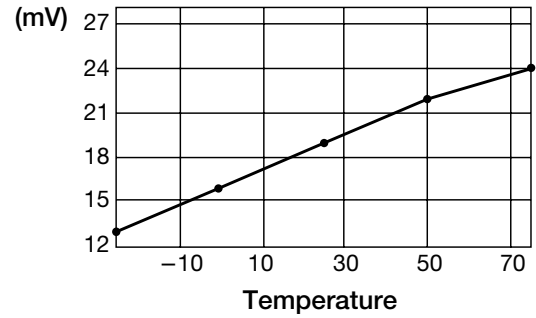

■ Output sink current 1  
Temperature characteristics

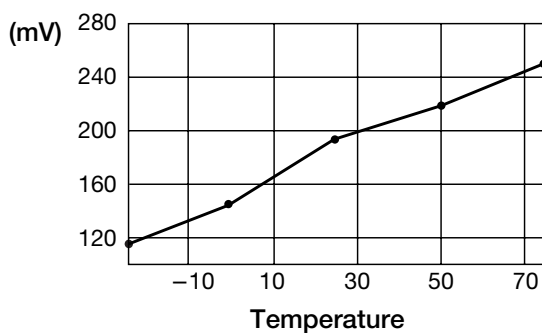

■ Output saturation voltage 1  
Temperature characteristics

