

SC-59 Quad Monolithic Common Anode

Transient Voltage Suppressor for ESD Protection

This quad monolithic silicon voltage suppressor is designed for applications requiring transient overvoltage protection capability. It is intended for use in voltage and ESD sensitive equipment such as computers, printers, business machines, communication systems, medical equipment, and other applications. Its quad junction common anode design protects four separate lines using only one package. These devices are ideal for situations where board space is at a premium.

Specification Features:

- SC-59 Package Allows Four Separate Unidirectional Configurations
- Peak Power — Min. 24 W @ 1.0 ms (Unidirectional), per Figure 5 Waveform
- Peak Power — Min. 150 W @ 20 μ s (Unidirectional), per Figure 6 Waveform
- Maximum Clamping Voltage @ Peak Pulse Current
- Low Leakage < 2.0 μ A
- ESD Rating of Class N (exceeding 16 kV) per the Human Body Model

Mechanical Characteristics:

- Void Free, Transfer-Molded, Thermosetting Plastic Case
- Corrosion Resistant Finish, Easily Solderable
- Package Designed for Optimal Automated Board Assembly
- Small Package Size for High Density Applications
- Available in 8 mm Tape and Reel

Use the Device Number to order the 7 inch/3,000 unit reel. Replace with "T3" in the Device Number to order the 13 inch/10,000 unit reel.

MMQA Series

Motorola Preferred Devices

**SC-59 QUAD
TRANSIENT VOLTAGE
SUPPRESSOR
24 WATTS PEAK POWER
5.6 – 33 VOLTS**

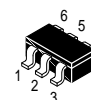

**CASE 318F-01
STYLE 1
SC-59 PLASTIC**

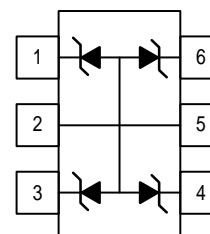

PIN 1. CATHODE
2. ANODE
3. CATHODE
4. CATHODE
5. ANODE
6. CATHODE

THERMAL CHARACTERISTICS ($T_A = 25^\circ\text{C}$ unless otherwise noted)

Characteristic	Symbol	Value	Unit
Peak Power Dissipation @ 1.0 ms (1) @ $T_A \leq 25^\circ\text{C}$	P_{pk}	24	Watts
Peak Power Dissipation @ 20 μ s (2) @ $T_A \leq 25^\circ\text{C}$	P_{pk}	150	Watts
Total Power Dissipation on FR-5 Board (3) @ $T_A = 25^\circ\text{C}$	P_D	225 1.8	mW mW/ $^\circ\text{C}$
Thermal Resistance from Junction to Ambient	$R_{\theta JA}$	556	$^\circ\text{C}/\text{W}$
Total Power Dissipation on Alumina Substrate (4) @ $T_A = 25^\circ\text{C}$ Derate above 25°C	P_D	300 2.4	mW mW/ $^\circ\text{C}$
Thermal Resistance from Junction to Ambient	$R_{\theta JA}$	417	$^\circ\text{C}/\text{W}$
Junction and Storage Temperature Range	T_J, T_{stg}	- 55 to +150	$^\circ\text{C}$
Lead Solder Temperature — Maximum (10 Second Duration)	T_L	260	$^\circ\text{C}$

1. Non-repetitive current pulse per Figure 5 and derate above $T_A = 25^\circ\text{C}$ per Figure 4.
2. Non-repetitive current pulse per Figure 6 and derate above $T_A = 25^\circ\text{C}$ per Figure 4.
3. FR-5 = 1.0 x 0.75 x 0.62 in.
4. Alumina = 0.4 x 0.3 x 0.024 in., 99.5% alumina

Preferred devices are Motorola recommended choices for future use and best overall value.

Thermal Clad is a trademark of the Bergquist Company

ELECTRICAL CHARACTERISTICS ($T_A = 25^\circ\text{C}$ unless otherwise noted)

UNIDIRECTIONAL (Circuit tied to pins 1, 2, and 5; Pins 2, 3, and 5; Pins 2, 4, and 5; or Pins 2, 5, and 6) ($V_F = 0.9\text{ V Max @ } I_F = 10\text{ mA}$)

Device	Breakdown Voltage				Max Reverse Leakage Current		Max Zener Impedance (7)	Max Reverse Surge Current	Max Reverse Voltage @ $I_{RSM}(6)$ (Clamping Voltage)	Maximum Temperature Coefficient of V_Z
	Min	$V_{ZT}(5)$ (V)	Nom	Max	@ I_{ZT}	I_R				
Device	Min	Nom	Max	(mA)	(nA)	(V)	Z_{ZT} @ I_{ZT} (Ω)	$I_{RSM}(4)$ (A)	V_{RSM} (V)	(mV/ $^\circ\text{C}$)
MMQA5V6T1,T3	5.32	5.6	5.88	1.0	2000	3.0	400	3.0	8.0	1.26
MMQA6V2T1,T3	5.89	6.2	6.51	1.0	700	4.0	300	2.66	9.0	10.6
MMQA6V8T1,T3	6.46	6.8	7.14	1.0	500	4.3	300	2.45	9.8	10.9
MMQA12VT1,T3	11.4	12	12.6	1.0	75	9.1	80	1.39	17.3	14
MMQA13VT1,T3	12.4	13	13.7	1.0	75	9.8	80	1.29	18.6	15
MMQA15VT1,T3	14.3	15	15.8	1.0	75	11	80	1.1	21.7	16
MMQA18VT1,T3	17.1	18	18.9	1.0	75	14	80	0.923	26	19
MMQA20VT1,T3	19	20	21	1.0	75	15	80	0.84	28.6	20.1
MMQA21VT1,T3	20	21	22.1	1.0	75	16	80	0.792	30.3	21
MMQA22VT1,T3	20.9	22	23.1	1.0	75	17	80	0.758	31.7	22
MMQA24VT1,T3	22.8	24	25.2	1.0	75	18	100	0.694	34.6	25
MMQA27VT1,T3	25.7	27	28.4	1.0	75	21	125	0.615	39	28
MMQA30VT1,T3	28.5	30	31.5	1.0	75	23	150	0.554	43.3	32
MMQA33VT1,T3	31.4	33	34.7	1.0	75	25	200	0.504	48.6	37

(5) V_Z measured at pulse test current I_T at an ambient temperature of 25°C .

(6) Surge current waveform per Figure 5 and derate per Figure 4.

(7) Z_{ZT} is measured by dividing the AC voltage drop across the device by the AC current supplied. The specified limits are $I_{Z(AC)} = 0.1 I_{Z(DC)}$, with AC frequency = 1 kHz.

NOTE: SPECS LISTED ABOVE ARE PRELIMINARY

TYPICAL CHARACTERISTICS

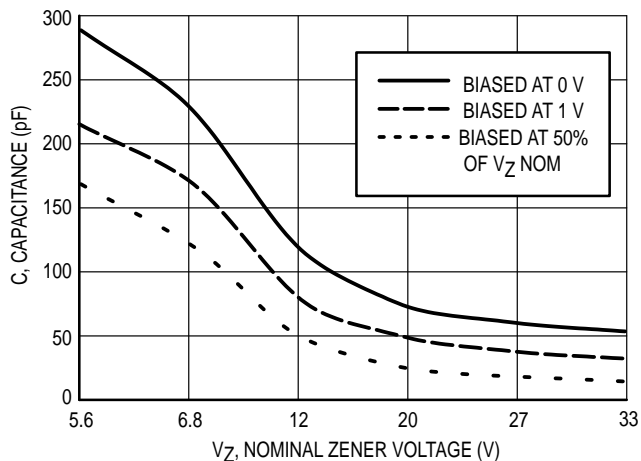

Figure 1. Typical Capacitance

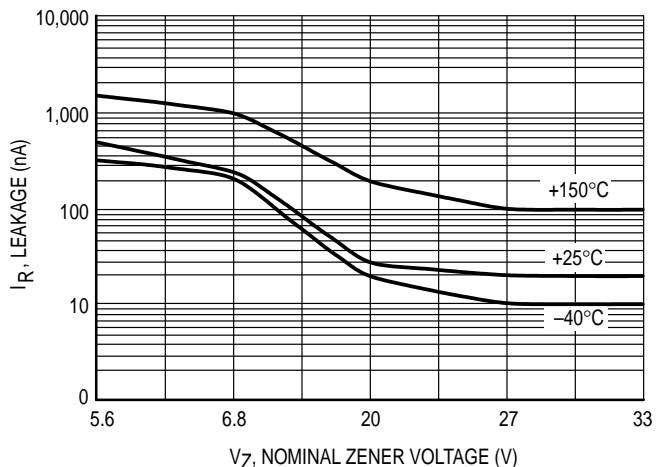

Figure 2. Typical Leakage Current

TYPICAL CHARACTERISTICS

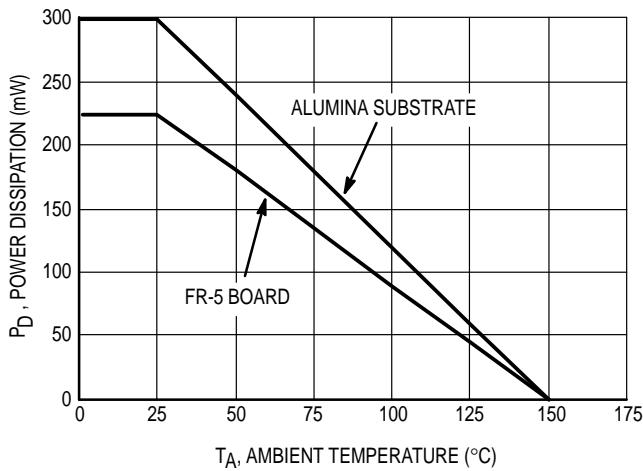

Figure 3. Steady State Power Derating Curve

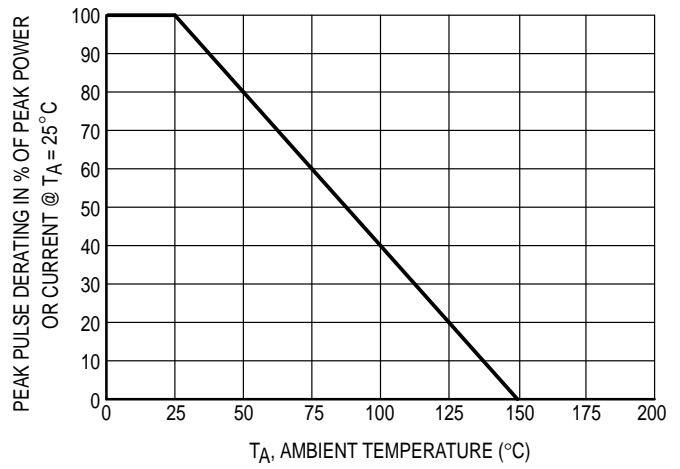

Figure 4. Pulse Derating Curve

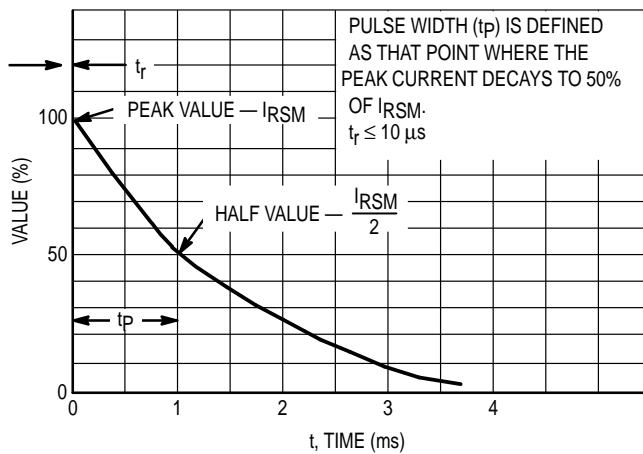

Figure 5. 10 × 1000 µs Pulse Waveform

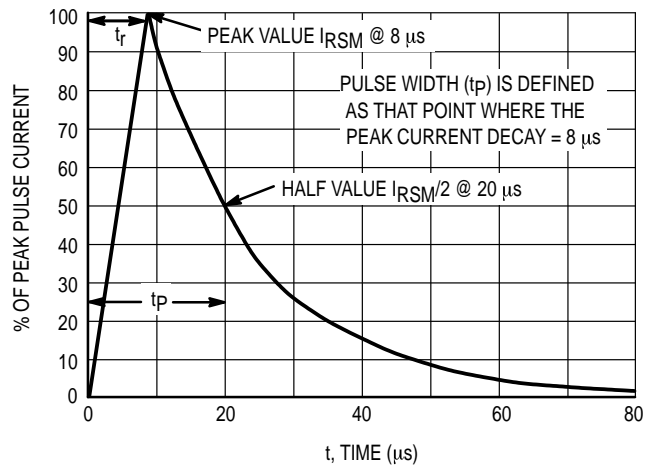

Figure 6. 8 × 20 µs Pulse Waveform

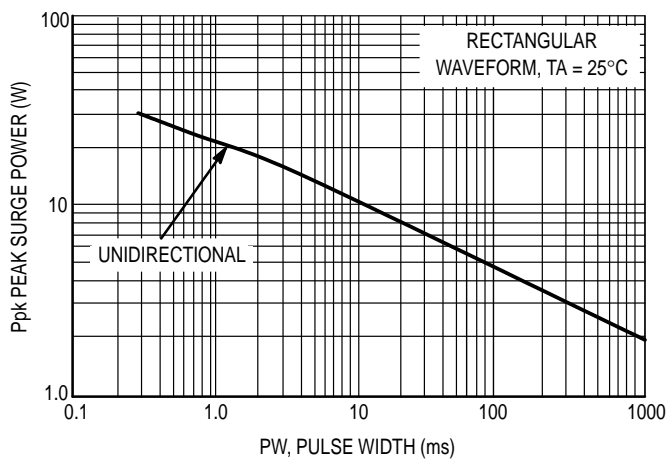

Figure 7. Maximum Non-Repetitive Surge Power, Ppk versus PW

Power is defined as $V_{RSM} \times I_Z(pk)$ where V_{RSM} is the clamping voltage at $I_Z(pk)$.

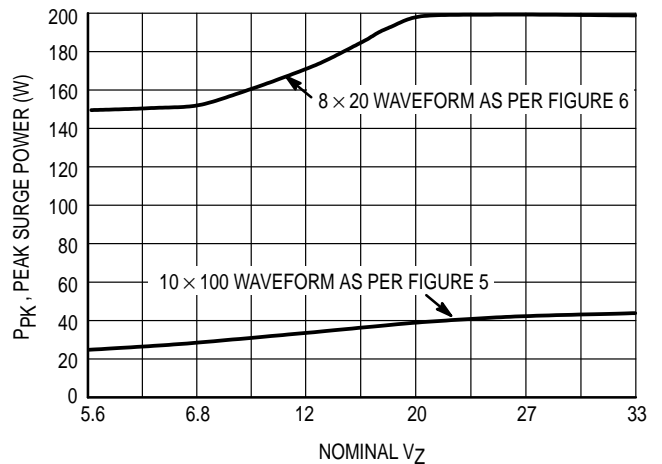

Figure 8. Typical Maximum Non-Repetitive Surge Power, Ppk versus VBR

TYPICAL COMMON ANODE APPLICATIONS

A quad junction common anode design in a SC-59 package protects four separate lines using only one package. This adds flexibility and creativity to PCB design especially

when board space is at a premium. A simplified example of MMQA Series Device applications is illustrated below.

Computer Interface Protection

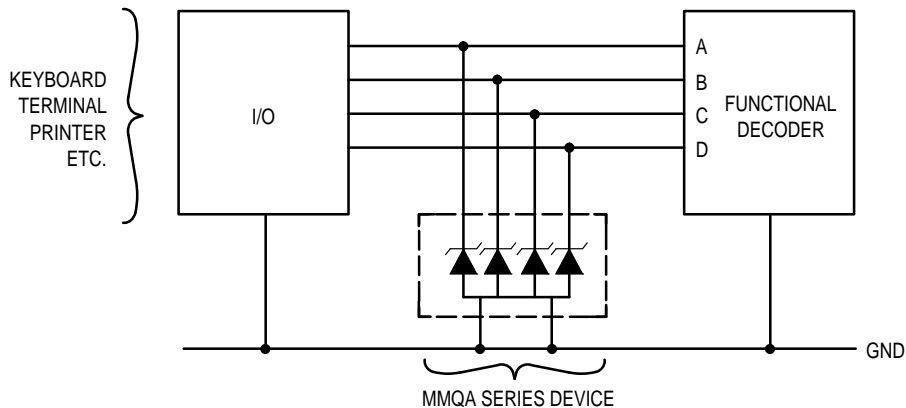

Microprocessor Protection

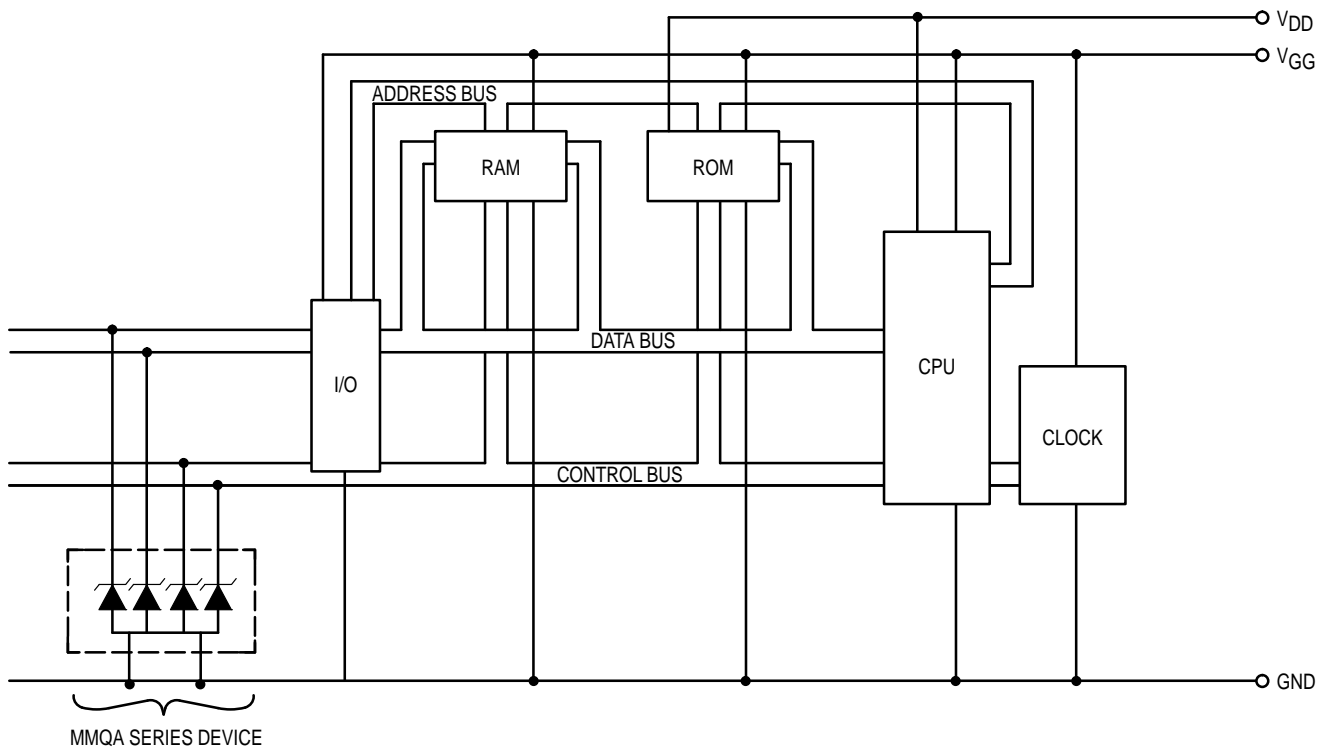

INFORMATION FOR USING THE SC-59 6 LEAD SURFACE MOUNT PACKAGE

MINIMUM RECOMMENDED FOOTPRINT FOR SURFACE MOUNTED APPLICATIONS

Surface mount board layout is a critical portion of the total design. The footprint for the semiconductor packages must be the correct size to ensure proper solder connection inter-

face between the board and the package. With the correct pad geometry, the packages will self-align when subjected to a solder reflow process.

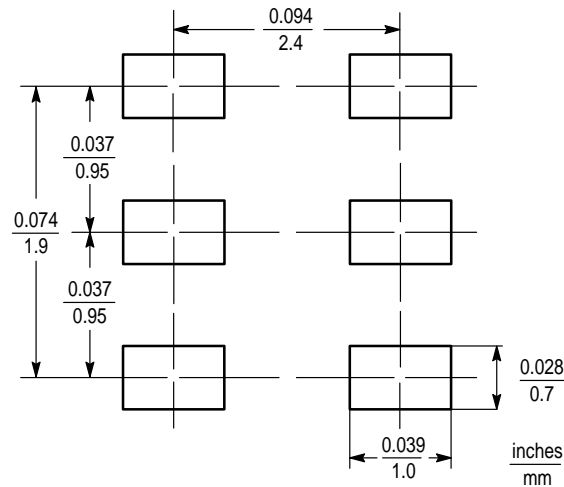

SC-59 6 LEAD

SC-59 6 LEAD POWER DISSIPATION

The power dissipation of the SC-59 6 Lead is a function of the pad size. This can vary from the minimum pad size for soldering to a pad size given for maximum power dissipation. Power dissipation for a surface mount device is determined by $T_{J(max)}$, the maximum rated junction temperature of the die, $R_{\theta JA}$, the thermal resistance from the device junction to ambient, and the operating temperature, T_A . Using the values provided on the data sheet for the SC-59 6 Lead package, P_D can be calculated as follows:

$$P_D = \frac{T_{J(max)} - T_A}{R_{\theta JA}}$$

The values for the equation are found in the maximum ratings table on the data sheet. Substituting these values into the equation for an ambient temperature T_A of 25°C, one can

calculate the power dissipation of the device which in this case is 225 milliwatts.

$$P_D = \frac{150^\circ\text{C} - 25^\circ\text{C}}{556^\circ\text{C/W}} = 225 \text{ milliwatts}$$

The 556°C/W for the SC-59 6 Lead package assumes the use of the recommended footprint on a glass epoxy printed circuit board to achieve a power dissipation of 225 milliwatts. There are other alternatives to achieving higher power dissipation from the SC-59 6 Lead package. Another alternative would be to use a ceramic substrate or an aluminum core board such as Thermal Clad™. Using a board material such as Thermal Clad, an aluminum core board, the power dissipation can be doubled using the same footprint.

SOLDER STENCIL GUIDELINES

Prior to placing surface mount components onto a printed circuit board, solder paste must be applied to the pads. Solder stencils are used to screen the optimum amount. These stencils are typically 0.008 inches thick and may be made of brass or stainless steel. For packages such as the

SC-59, SC-59 6 Lead, SC-70/SOT-323, SOD-123, SOT-23, SOT-143, SOT-223, SO-8, SO-14, SO-16, and SMB/SMC diode packages, the stencil opening should be the same as the pad size or a 1:1 registration.

SOLDERING PRECAUTIONS

The melting temperature of solder is higher than the rated temperature of the device. When the entire device is heated to a high temperature, failure to complete soldering within a short time could result in device failure. Therefore, the following items should always be observed in order to minimize the thermal stress to which the devices are subjected.

- Always preheat the device.
- The delta temperature between the preheat and soldering should be 100°C or less.*

- When preheating and soldering, the temperature of the leads and the case must not exceed the maximum temperature ratings as shown on the data sheet. When using infrared heating with the reflow soldering method, the difference should be a maximum of 10°C.

* Soldering a device without preheating can cause excessive thermal shock and stress which can result in damage to the device.

- The soldering temperature and time should not exceed 260°C for more than 10 seconds.
- When shifting from preheating to soldering, the maximum temperature gradient should be 5°C or less.
- After soldering has been completed, the device should be allowed to cool naturally for at least three minutes.

- Gradual cooling should be used since the use of forced cooling will increase the temperature gradient and will result in latent failure due to mechanical stress.
- Mechanical stress or shock should not be applied during cooling.

TYPICAL SOLDER HEATING PROFILE

For any given circuit board, there will be a group of control settings that will give the desired heat pattern. The operator must set temperatures for several heating zones and a figure for belt speed. Taken together, these control settings make up a heating “profile” for that particular circuit board. On machines controlled by a computer, the computer remembers these profiles from one operating session to the next. Figure 9 shows a typical heating profile for use when soldering a surface mount device to a printed circuit board. This profile will vary among soldering systems, but it is a good starting point. Factors that can affect the profile include the type of soldering system in use, density and types of components on the board, type of solder used, and the type of board or substrate material being used. This profile shows temperature versus time. The line on the graph shows the

actual temperature that might be experienced on the surface of a test board at or near a central solder joint. The two profiles are based on a high density and a low density board. The Vitronics SMD310 convection/infrared reflow soldering system was used to generate this profile. The type of solder used was 62/36/2 Tin Lead Silver with a melting point between 177–189°C. When this type of furnace is used for solder reflow work, the circuit boards and solder joints tend to heat first. The components on the board are then heated by conduction. The circuit board, because it has a large surface area, absorbs the thermal energy more efficiently, then distributes this energy to the components. Because of this effect, the main body of a component may be up to 30 degrees cooler than the adjacent solder joints.

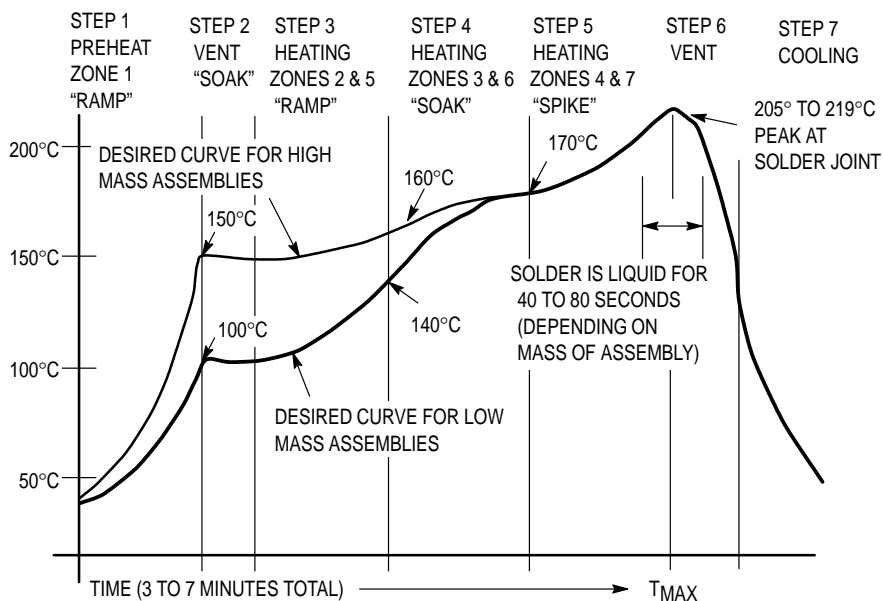
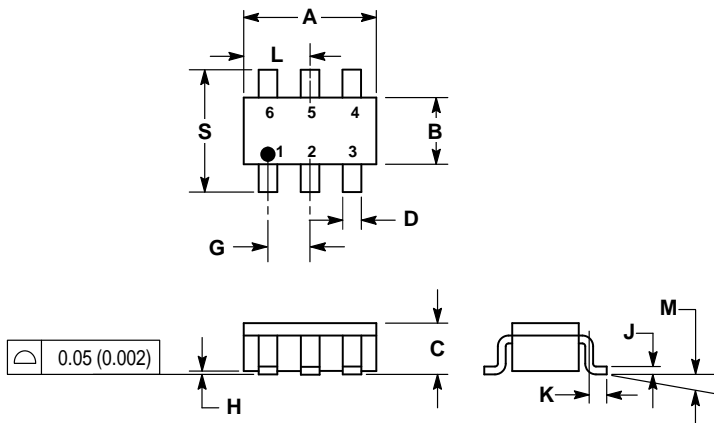

Figure 9. Typical Solder Heating Profile

OUTLINE DIMENSIONS



- NOTES:
1. DIMENSIONING AND TOLERANCING PER ANSI Y14.5M, 1982.
 2. CONTROLLING DIMENSION: INCH.
 3. MAXIMUM LEAD THICKNESS INCLUDES LEAD FINISH THICKNESS. MINIMUM LEAD THICKNESS IS THE MINIMUM THICKNESS OF BASE MATERIAL.

DIM	INCHES		MILLIMETERS	
	MIN	MAX	MIN	MAX
A	0.1063	0.1220	2.70	3.10
B	0.0512	0.0669	1.30	1.70
C	0.0394	0.0511	1.00	1.30
D	0.0138	0.0196	0.35	0.50
G	0.0335	0.0413	0.85	1.05
H	0.0005	0.0040	0.013	0.100
J	0.0040	0.0102	0.10	0.26
K	0.0079	0.0236	0.20	0.60
L	0.0493	0.0649	1.25	1.65
M	0°	10°	0°	10°
S	0.0985	0.1181	2.50	3.00

- STYLE 1:
 PIN 1. CATHODE
 2. ANODE
 3. CATHODE
 4. CATHODE
 5. ANODE
 6. CATHODE

**CASE 318F-01
 ISSUE A
 SC-59 6 LEAD**

Motorola reserves the right to make changes without further notice to any products herein. Motorola makes no warranty, representation or guarantee regarding the suitability of its products for any particular purpose, nor does Motorola assume any liability arising out of the application or use of any product or circuit, and specifically disclaims any and all liability, including without limitation consequential or incidental damages. "Typical" parameters which may be provided in Motorola data sheets and/or specifications can and do vary in different applications and actual performance may vary over time. All operating parameters, including "Typicals" must be validated for each customer application by customer's technical experts. Motorola does not convey any license under its patent rights nor the rights of others. Motorola products are not designed, intended, or authorized for use as components in systems intended for surgical implant into the body, or other applications intended to support or sustain life, or for any other application in which the failure of the Motorola product could create a situation where personal injury or death may occur. Should Buyer purchase or use Motorola products for any such unintended or unauthorized application, Buyer shall indemnify and hold Motorola and its officers, employees, subsidiaries, affiliates, and distributors harmless against all claims, costs, damages, and expenses, and reasonable attorney fees arising out of, directly or indirectly, any claim of personal injury or death associated with such unintended or unauthorized use, even if such claim alleges that Motorola was negligent regarding the design or manufacture of the part. Motorola and  are registered trademarks of Motorola, Inc. Motorola, Inc. is an Equal Opportunity/Affirmative Action Employer.

How to reach us:

USA/EUROPE/Locations Not Listed: Motorola Literature Distribution;
P.O. Box 5405; Denver, Colorado 80217. 1-800-441-2447

MFAX: RMFAX0@email.sps.mot.com – TOUCHTONE 602-244-6609

INTERNET: <http://Design-NET.com>

JAPAN: Nippon Motorola Ltd.; Tatsumi-SPD-JLDC, 6F Seibu-Butsuryu-Center,
3-14-2 Tatsumi Koto-Ku, Tokyo 135, Japan. 81-3-3521-8315

ASIA/PACIFIC: Motorola Semiconductors H.K. Ltd.; 8B Tai Ping Industrial Park,
51 Ting Kok Road, Tai Po, N.T., Hong Kong. 852-26629298



MOTOROLA



MMQA/D