

**MPX200**  
**MPX201**  
**(A,AP,D,DP,GP,GVP)**

**X-ducer**  
**SILICON PRESSURE SENSOR**  
**0 TO 29 PSI**

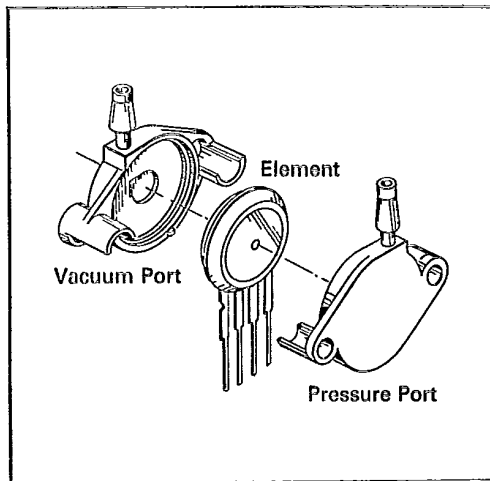

**METHOD FOR NUMBERING DEVICE**

MPX  $\frac{XX}{A} \frac{X}{B} \frac{A}{C} \frac{\_}{D}$

MPX — Indicates Motorola pressure X-ducer.

- A. Output pressure rating in kilo pascal (kPa) divided by 10. The International Metric System (SI) unit of measure for pressure is a Pascal (Newton/Meter<sup>2</sup>).
- B. Indicates different performance levels in the electrical specification.
- C. Character(s) is an "A" or "D" for absolute or differential pressure or G or GV for gauge or gauge vacuum.
- D. A P as the last digit (optional) indicates that the unit is supplied with pressure port(s).

EXAMPLE: MPX201D  
 200 kPa range, special electrical performance, differential sensor element, supplied without port.

**VOLTAGE OUTPUT versus APPLIED DIFFERENTIAL PRESSURE**

The voltage output of the X-ducer is directly proportional to the differential pressure applied.

The ABSOLUTE Basic Elements and ABSOLUTE Ported Elements have a built in reference vacuum of approximately 0 kPa. The output voltage increases with increasing pressure relative to ambient pressure ( $\approx 100$  kPa) applied to the pressure side. Care should be taken to limit positive pressure to approximately 100 kPa relative to ambient so that the total differential operating pressure range of 200 kPa is not exceeded. Conversely, the output voltage will decrease as vacuum, relative to ambient, is drawn. Vacuum down to the 0 kPa reference

can be measured with the indicated accuracy.

The output voltage of the Differential Element, Differential Ported and Gage Ported sensors increases with increasing pressure applied to the pressure side relative to the vacuum side. Similarly, output voltage increases as increasing vacuum is applied to the vacuum side relative to the pressure side of the Differential units.

The output voltage of the Gage Vacuum Ported sensor increases with increasing vacuum (decreasing pressure) applied to the vacuum side with the pressure side at ambient.

MPX200 > MPX201

**OPERATING CHARACTERISTICS** ( $V_S = 3.0 \text{ Vdc}$ ,  $T_A = 25^\circ\text{C}$  unless otherwise noted.)

Characteristics	Symbol	Min	Typ	Max	Unit
Differential Pressure Range <sup>1</sup> , Figure 1	POP	0	—	200	kPa
Supply Voltage	$V_S$	—	3.0	6.0	Vdc
Supply Current	$I_o$	—	6.0	—	mAdc

**OPERATING PRESSURE RANGE**

The min and max pressure at which the output will meet the specified operating characteristics.

**SUPPLY VOLTAGE**

Also called EXCITATION VOLTAGE.

The output signal of the device is directly proportional to excitation voltage at a given pressure. For example, a typical MPX200 element having  $V_{FSS} = 60 \text{ mV}$  at  $V_S = 3.0 \text{ V}$  will have  $V_{FSS} = 120 \text{ mV}$  at  $V_S = 6.0$  and  $V_{FSS} = 20 \text{ mV}$  at  $V_S = 1.0 \text{ V}$ .

Because of this ratiometric behavior a regulated power supply is recommended. Devices must be powered by constant current or constant voltage.

**SUPPLY CURRENT**

Is a function of the input resistance and the supply voltage.

In case where constant current excitation mode is used, care must be given to the limit of the current level such that corresponding excitation voltage is less than 6.0 V.

Full Scale Span <sup>2</sup> , Figure 1	$V_{FSS}$	45	60	90	mV
Zero Pressure Offset, Figure 1	$V_{off}$	0	20	35	mV
Sensitivity	$\Delta V/\Delta P$	—	0.30	—	mV/kPa

**FULL SCALE SPAN**

The span of a device is the output voltage variation given between 0 pressure and a given pressure, which for full scale span is the maximum recommended operating pressure.

Min and max are guaranteed limits for all pressure sensors.

**ZERO PRESSURE OFFSET**

This is the signal level given by a sensor with 0 applied pressure.

Min and max are guaranteed limits for all pressure sensors.

(The output of the sensor is given as  $V_{off} + \text{span}$ .)

**SENSITIVITY**

Is the full scale span divided by the max operating pressure

$$\text{SENSITIVITY} = \frac{V_{FSS}}{POP}$$

Values given are typical. However, min and max values can be easily obtained. Example: an MPX200 having  $V_{FSS} = 90 \text{ mV}$  at 200 kPa input will have a sensitivity of

$$\frac{90 \text{ mV}}{200 \text{ kPa}} = 0.45 \text{ mV/kPa}$$

The sensitivity is assumed to be the same whatever is the pressure inside operating pressure range. (see § LINEARITY).

MPX200 & MPX201

**OPERATING CHARACTERISTICS** ( $V_S = 3.0 \text{ Vdc}$ ,  $T_A = 25^\circ\text{C}$  unless otherwise noted.)

Characteristics		Symbol	Min	Typ	Max	Unit
Linearity <sup>3</sup>	MPX200	—	—	$\pm 0.05$	$\pm 0.1$	%FS
	MPX201	—	—	$\pm 0.10$	$\pm 0.2$	%FS
Pressure Hysteresis <sup>4</sup> (0 to 200 kPa)		—	—	$\pm 0.05$	$\pm 0.1$	%FS
Temperature Hysteresis <sup>5</sup> (-40°C to +125°C)		—	—	$\pm 0.5$	—	%FS

**LINEARITY (ERROR)**

The maximum deviation of the output from a straight line relationship over the operating pressure range.

An MPX200, with max linearity of  $\pm 0.01\%$ , with  $V_{FSS} = 50 \text{ mV}$  would have a maximum linearity adjustment of  $\pm 0.5 \mu\text{V}$  regardless of the pressure applied in the specified operating range.

This extremely good linearity allows the assumption that the same value of sensitivity occurs at any point of the operating pressure range.

SEE ADDITIONAL DISCUSSION OF LINEARITY (Page 9)

**PRESSURE HYSTERESIS**

The difference in the output at any pressure in the operating pressure range when this pressure is approached from the minimum operating pressure and when approached from the maximum operating pressure at room temperature.

Pressure hysteresis is given as a percentage of the full scale span.

Example: an MPX200 having a  $\pm 0.1$  pressure hysteresis with  $V_{FSS}$  of 90 mV should have, at 100 kPa, a maximum pressure hysteresis of:  $\pm 0.1\% \times 90 \text{ mV} = \pm 0.9 \text{ mV}$ .

(The extremely low pressure hysteresis is related to inherent elasticity of the silicon diaphragm.)

**TEMPERATURE HYSTERESIS**

The difference in the output at any temperature in the operating temperature range when this temperature is approached from the minimum operating temperature ( $-40^\circ\text{C}$ ) and when approached from the maximum operating temperature ( $+125^\circ\text{C}$ ) at zero pressure applied.

Temperature hysteresis is given as a percentage of full scale span.

It is related to the stress absorbing capabilities of each constituent in the sensor package.

Motorola's pressure sensor die is mounted in a highly compliant silicone elastomer which is highly resistant to thermal fatigue.

Example: similar to pressure hysteresis.

SEE ADDITIONAL DISCUSSION OF HYSTERESIS (Page 9)

**ORDERING INFORMATION:**

MPX Series "X-ducer" silicon pressure sensors are available in absolute, differential, and gage configurations. Devices are available in the BASIC ELEMENT package or with pressure port fittings which provide mounting ease and barbed hose connections.

Device Type	Options	Package Style	MPX Series	
			200	201
Basic Element	Absolute	Case 344-03	MPX200A	MPX201A
	Differential	Case 344-03	MPX200D	MPX201D
Ported Element	Absolute	Case 350-01	MPX200AP	MPX201AP
	Differential	Case 352-01	MPX200DP	MPX201DP
	Gage	Case 350-01	MPX200GP	MPX201GP
	Gage Vacuum	Case 350-02	MPX200GVP	MPX201GVP

**MPX200 (MPX200)**

**OPERATING CHARACTERISTICS** ( $V_S = 3.0 \text{ Vdc}$ ,  $T_A = 25^\circ\text{C}$  unless otherwise noted.)

Characteristics	Symbol	Min	Typ	Max	Unit
Temperature Coefficient of Full Scale Span <sup>6</sup>	TCV <sub>FSS</sub>	-0.22	-0.19	-0.16	%/°C
Temperature Coefficient of Offset <sup>7</sup>	TCV <sub>off</sub>	—	±15	—	μV/°C

**TEMPERATURE COEFFICIENT OF FULL SCALE SPAN — TCV<sub>FSS</sub>**

The percent change in full scale span (in mV) per unit change in temperature (in °C) relative to the full scale span at a specified temperature (25°C).

The variation of  $V_{FSS}$  versus temperature is linear. The temperature coefficient of full scale span is given by:

$$TCV_{FSS} = \frac{V_{FSS}}{T} \times \frac{1}{V_{FSS}(25^\circ\text{C})}$$

Example : an MPX200 with  $V_{FSS} = 45 \text{ mV}$  at  $25^\circ\text{C}$  and  $TCV_{FSS} = -0.22\%$  would have:

$$V_{FSS} = 45 \text{ mV} + [45 \text{ mV} \times (-0.22\% / ^\circ\text{C}) \times 100^\circ\text{C}] = 35.4 \text{ mV at } 125^\circ\text{C}$$

$$V_{FSS} = 45 \text{ mV} + [45 \text{ mV} \times (-0.22\% / ^\circ\text{C}) \times (-65^\circ\text{C})] = 61.44 \text{ mV at } -40^\circ\text{C}$$

Note that the slope is always negative and for this reason, the MPX pressure sensors can be easily temperature compensated for span by using a series resistor technique (see Application Note AN840 or AN922).

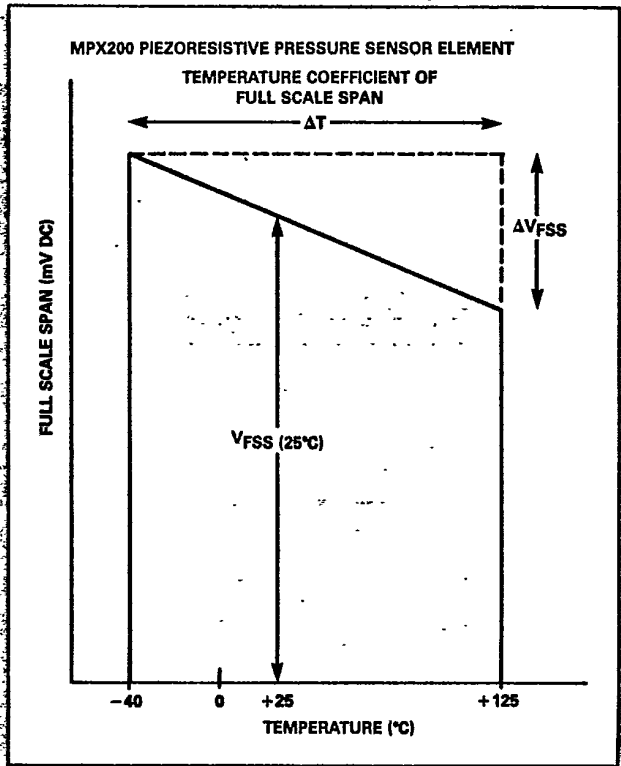

**TEMPERATURE COEFFICIENT OF OFFSET — TCV<sub>off</sub>**

The change in zero pressure offset per unit change in temperature at a specified supply voltage or current.

The variation of  $V_{off}$  versus temperature is linear. The temperature coefficient of offset is given by:

$$TCV_{off} = \left( \frac{\Delta V_{off}}{\Delta T} \right) \times \frac{1}{V_{off}(25^\circ\text{C})}$$

Calculation is the same as for TCV<sub>FSS</sub>.

Figure 1 shows the typical output characteristics of an MPX200D pressure transducer. Note from the figure that both the zero pressure offset and the full scale span are temperature sensitive thus having associated temperature coefficients.

**FIGURE 1 — OUTPUT versus PRESSURE DIFFERENTIAL**

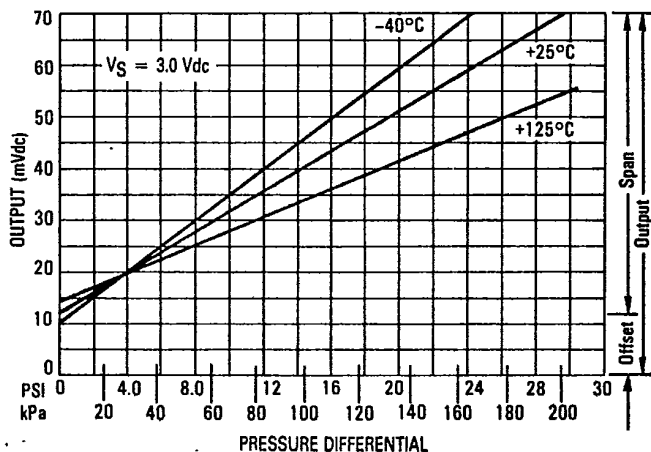

**MPX200 ○ MPX201**

**OPERATING CHARACTERISTICS** ( $V_S = 3.0 \text{ Vdc}$ ,  $T_A = 25^\circ\text{C}$  unless otherwise noted.)

Characteristics	Symbol	Min	Typ	Max	Unit
Temperature Coefficient of Resistance <sup>8</sup>	TCR	0.21	0.24	0.27	%/°C
Input Resistance	$R_O$	400	—	550	$\Omega$
Response Time <sup>9</sup> (10% to 90%)	$t_R$	—	1.0	—	ms

**NOTES:**

1. 1.0 kPa (kiloPascal) equals 0.145 PSI.
2. Measured at 3.0 Vdc excitation for 200 kPa pressure differential.
3. Maximum deviation from end-point straight line fit at 0 and 200 kPa.
4. Maximum output difference at any pressure point within  $P_{OP}$  for increasing and decreasing pressures.
5. Maximum output difference at any pressure point within  $P_{OP}$  for increasing and decreasing temperatures in the range  $-40^\circ\text{C}$  to  $+125^\circ\text{C}$ .
6. Slope of end-point straight line fit to full scale span at  $-40^\circ\text{C}$  and  $+125^\circ\text{C}$ , relative to  $+25^\circ\text{C}$ .
7. Slope of end-point straight line fit to zero pressure offset at  $-40^\circ\text{C}$  and  $+125^\circ\text{C}$ .
8. Slope of end-point straight line fit to input resistance at  $-40^\circ\text{C}$  and  $+125^\circ\text{C}$ , relative to resistance at  $+25^\circ\text{C}$ .
9. For a 0 to 200 kPa pressure step change.
10. Repeatability ( $\pm 0.5\%$ FS typical) is defined as the maximum difference in output at any pressure within  $P_{OP}$  and temperature within  $+10^\circ\text{C}$  to  $+85^\circ\text{C}$  after:
  - a. 1000 temperature cycles,  $-40^\circ\text{C}$  to  $+125^\circ\text{C}$ .
  - b. 1.5 million pressure cycles, 0 to 160 kPa.

**TEMPERATURE COEFFICIENT OF RESISTANCE**

The variation of input resistance versus temperature is linear.  
The temperature coefficient of resistance is given by:

$$TCR = \left(\frac{R}{T}\right) \times \frac{1}{R(25^\circ\text{C})}$$

This coefficient is determined by the doping level and the material resistivity.

**NOTE: Temperature Error (in General)** The maximum change in output at any pressure in the operating pressure range when the temperature is changed over a specified temperature range.

**Input Impedance (Resistance)**

The impedance (resistance) measured between the positive and negative (ground) input terminals at a specified frequency with the output terminals open. For Motorola X-ducers this is a resistance measurement only.

**Response Time**

The time required for the incremental change in the output to go from 10% to 90% of its final value when subjected to a specified step change in pressure, for the MPX200 this is 200 kPa.

SEE DISCUSSION ON REPEATABILITY/STABILITY  
(Page 11)

**MPX200 - MPX201**

**TEMPERATURE COMPENSATION**

Figure 1 shows the effect of temperature on the output of the transducer.

Temperature compensation and offset calibration can be achieved rather simply with additional resistive components.

Several approaches to external temperature compensation over both -40 to +125°C and 0 to +80°C ranges are presented in Motorola Applications Notes AN840 and AN922. They are available from all Motorola Sales Offices.

**FIGURE 2 — ELECTRICAL CONNECTIONS**

Motorola's Silicon pressure sensor elements use a single piezoresistive strain gage to sense shear stress.

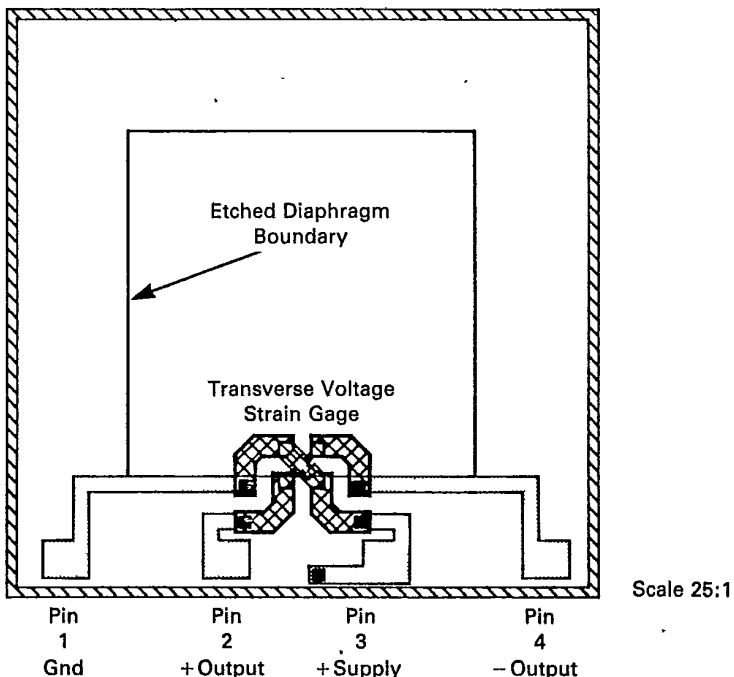

**FIGURE 3 — MPX PRESSURE SENSOR ELEMENT CROSS SECTION (DIFFERENTIAL)**

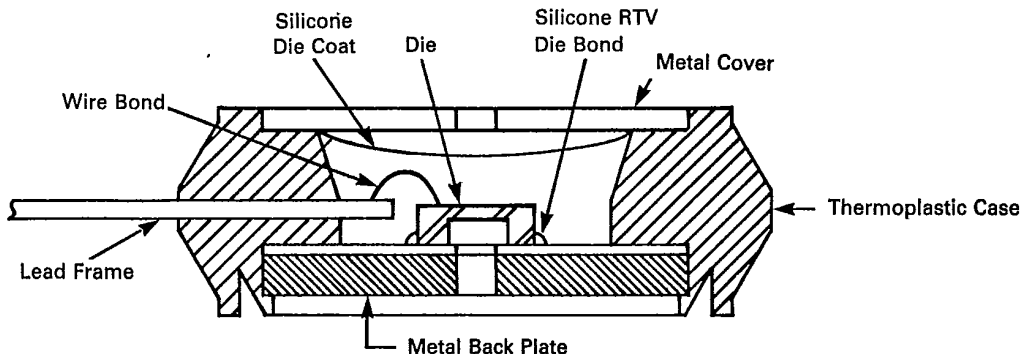

Figure 3 shows the cross section of the Motorola MPX pressure sensor die in the chip carrier package. A silicone gel isolates the die surface and wire bonds from

harsh environments, while allowing the pressure signal to be transmitted to the silicon diaphragm.

MPX200 • MPX201

**LINEARITY**

Linearity refers to how well a transducer's output follows the equation:  $V_{out} = V_{off} + \text{sensitivity} \times P$  over the operating pressure range. There are two basic methods for calculating nonlinearity: (1) end point straight line fit or (2) a least squares best line fit (see Figure A). While a least squares fit gives the "best case" linearity error (lower numerical value), the calculations required are burdensome.

Conversely, an end point fit will give the "worst case" error (often more desirable in error budget calculations) and the calculations are more straightforward for the user. Motorola's specified pressure sensor linearities are based on the end point straight line method measured at the midrange pressure.

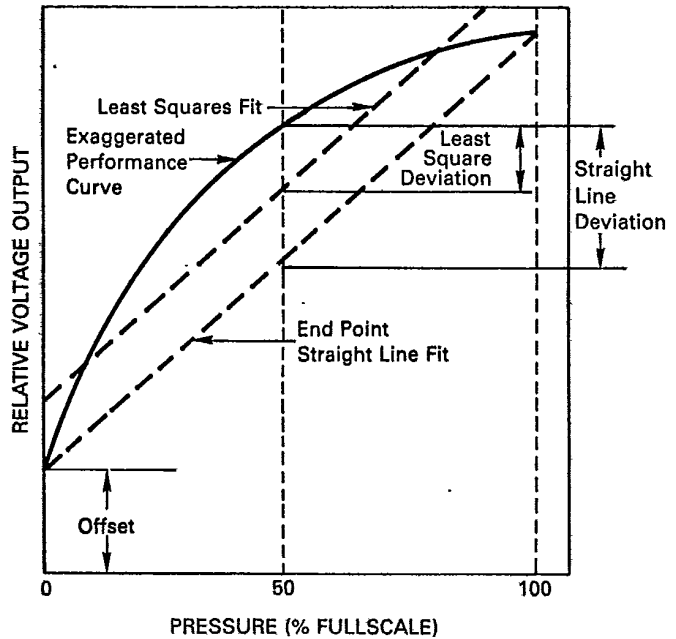

FIGURE A — LINEARITY SPECIFICATION COMPARISON ▶

**HYSTERESIS**

Hysteresis refers to a transducer's ability to produce the same output with the same applied measure and applied consecutively, first from an increasing direction and then from a decreasing direction. Pressure hysteresis is measured at a constant temperature while temperature hysteresis is measured at a constant pressure in the operating pressure range (see Figure B).

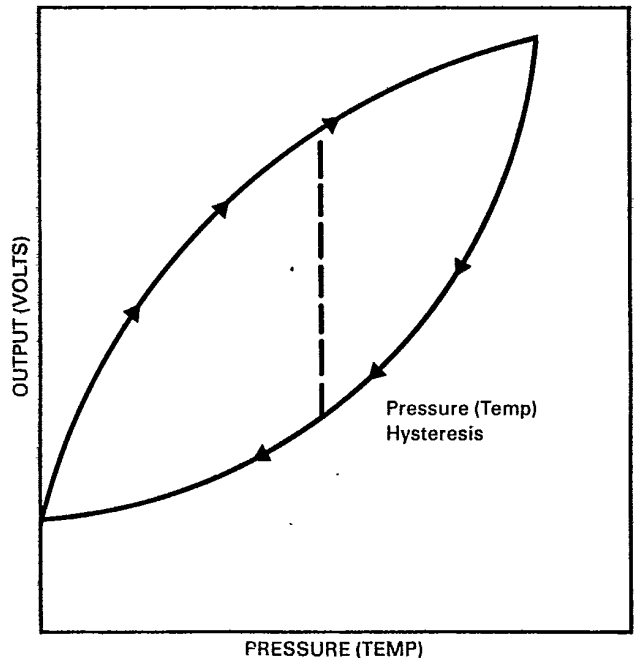

FIGURE B — HYSTERESIS ▶

MPX200 ○ MPX201

OUTLINE DIMENSIONS

BASIC ELEMENT (MPX200A,D)

**CASE 344-03**

DIM	MILLIMETERS		INCHES	
	MIN	MAX	MIN	MAX
A	15.37	15.62	0.605	0.615
B	13.21	13.46	0.520	0.530
C	4.95	5.72	0.195	0.225
D	0.41	0.50	0.016	0.020
F	1.22	1.32	0.048	0.052
G	2.54 BSC 0.100 BSC			
J	0.38	0.40	0.014	0.016
L	17.40	18.16	0.685	0.715
M	30° NOM 30° NOM			
N	12.19	12.70	0.480	0.500

**STYLE 1:**  
 PIN 1. GROUND  
 2. + OUTPUT  
 3. + SUPPLY  
 4. - OUTPUT

**NOTES:**  
 1. DIMENSION A IS DATUM.  
 2. POSITIONAL TOLERANCE FOR DIMENSION D LEADS:  
 [⊕] 0.136 (0.005) [⊙] A [⊙]  
 3. DIMENSIONING AND TOLERANCING PER ANSI Y14.5, 1973.

PRESSURE SIDE PORTED (MPX200AP,GP)

**CASE 350-01**

DIM	MILLIMETERS		INCHES	
	MIN	MAX	MIN	MAX
A	28.95	29.97	1.140	1.180
B	17.39	18.16	0.685	0.715
C	7.74	8.15	0.305	0.321
D	0.40	0.50	0.016	0.020
F	1.21	1.32	0.048	0.052
G	2.54 BSC 0.100 BSC			
H	4.62	4.92	0.182	0.194
J	0.35	0.40	0.014	0.016
K	17.39	18.16	0.685	0.715
L	23.11 BSC 0.910 BSC			
N	17.39	10.92	0.420	0.430
P	5.20 REF 0.205 REF			
Q	3.88	4.01	0.153	0.158
R	5.86	6.35	0.231	0.250
S	3.88	4.01	0.153	0.158
U	7.44	7.64	0.293	0.297

**STYLE 1:**  
 PIN 1. GROUND  
 2. + OUTPUT  
 3. + SUPPLY  
 4. - OUTPUT

**NOTES:**  
 1. DIMENSIONS A AND Q ARE DATUMS.  
 -T- IS A DATUM SURFACE.  
 2. POSITIONAL TOLERANCE FOR DIMENSION D LEADS:  
 [⊕] 0.136 (0.005) [⊙] A [⊙]  
 3. POSITIONAL TOLERANCE FOR MOUNTING HOLE - DIA S:  
 [⊕] 0.25 (0.010) [⊙] -T- [⊙] Q [⊙]  
 4. DIMENSIONING AND TOLERANCING PER ANSI Y14.5, 1973.  
 5. NOTCH IS PIN 1 INDICATOR.

POSITIONING OF DEVICE

Place the notch on the left hand side as indicated — the positive pressure port is up. Device marking and year, assembly week date code are on the top surface.

Attachment to pressure source can be made through o-ring clamping or epoxy attachment to pressure sealing surface, or to vacuum source by similar attachment to the surface opposite the pressure sealing surface. Attachment should not be made to flat surfaces.

TABLE A — Conversion for Common Units of Pressure

	kiloPascals	mm Hg	millibars	Inches H <sub>2</sub> O	psi
1 atm	101.325	760.000	1013.25	406.795	14.6960
1 kiloPascal	1.00000	7.50062	10.0000	4.01475	0.145038
1 mm Hg	0.133322	1.00000	1.33322	0.535257	0.0193368
1 millibar	0.100000	0.750062	1.00000	0.401475	0.0145038
1 inch H <sub>2</sub> O	0.249081	1.86826	2.49081	1.00000	0.0361263
1 psi	6.89473	51.7148	68.9473	27.6807	1.00000

Quick Conversion Chart for Common Units of Pressure

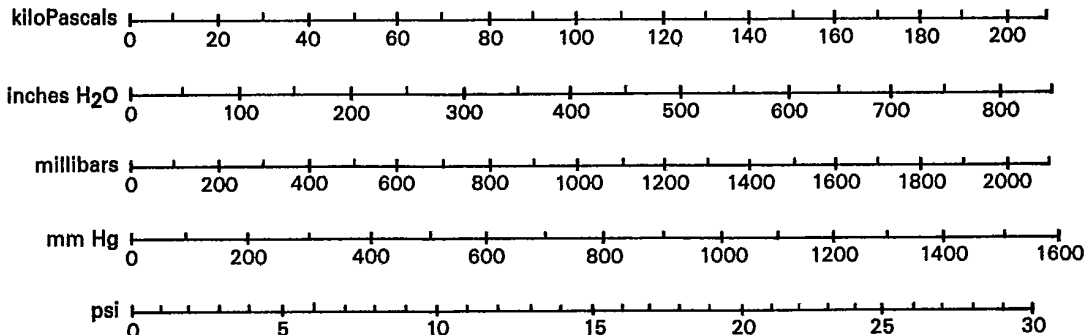



MPX200 > MPX201

OUTLINE DIMENSIONS

VACUUM SIDE PORTED (MPX200GVP)

**STYLE 1:**  
 PIN 1. GROUND  
 2. + OUTPUT  
 3. + SUPPLY  
 4. - OUTPUT

**CASE 350-02**

DIM	MILLIMETERS		INCHES	
	MIN	MAX	MIN	MAX
A	28.95	29.97	1.140	1.180
B	17.39	18.16	0.685	0.715
C	7.74	8.15	0.305	0.321
D	0.40	0.50	0.016	0.020
F	1.21	1.32	0.048	0.052
G	2.54 BSC		0.100 BSC	
H	4.62	4.92	0.182	0.194
J	0.35	0.40	0.014	0.016
K	17.39	18.16	0.685	0.715
L	23.11 BSC		0.910 BSC	
N	17.39	10.92	0.420	0.430
P	5.20 REF		0.205 REF	
Q	3.88	4.01	0.153	0.158
R	6.86	6.36	0.231	0.250
S	3.88	4.01	0.153	0.158
U	7.44	7.64	0.293	0.297

**NOTES:**  
 1. DIMENSIONS A AND Q ARE DATUMS.  
 -T- IS A DATUM SURFACE.  
 2. POSITIONAL TOLERANCE FOR DIMENSION D LEADS:  
 [0.136 (0.005) A]  
 3. POSITIONAL TOLERANCE FOR MOUNTING HOLE - DIA S:  
 [0.25 (0.010) T]  
 4. DIMENSIONING AND TOLERANCING PER ANSI Y14.5, 1973.  
 5. NOTCH IS PIN 1 INDICATOR.

PRESSURE AND VACUUM SIDES PORTED (MPX200DP)

**STYLE 1:**  
 PIN 1. GROUND  
 2. + OUTPUT  
 3. + SUPPLY  
 4. - OUTPUT

**CASE 352-01**

DIM	MILLIMETERS		INCHES	
	MIN	MAX	MIN	MAX
A	28.95	29.97	1.140	1.180
B	17.39	18.16	0.685	0.715
C	9.65	10.66	0.380	0.420
D	0.40	0.50	0.016	0.020
F	1.21	1.32	0.048	0.052
G	2.54 BSC		0.100 BSC	
H	4.62	4.92	0.182	0.194
J	0.35	0.40	0.014	0.016
K	17.39	18.16	0.685	0.715
L	23.11 BSC		0.910 BSC	
N	10.66	10.92	0.420	0.430
P	5.20 REF		0.205 REF	
Q	3.88	4.01	0.153	0.158
R	1.60	2.10	0.063	0.083
S	3.88	4.01	0.153	0.158
U	7.44	7.54	0.293	0.297
V	6.17	6.93	0.243	0.273
W	7.87	8.12	0.310	0.320

**NOTES:**  
 1. DIMENSIONS A AND Q ARE DATUMS.  
 DIMENSION -T- IS DATUM SURFACE.  
 2. DIMENSIONS H AND R, 2 PLACES.  
 3. POSITIONAL TOLERANCE FOR DIMENSION D LEADS:  
 [0.136 (0.005) A]  
 4. POSITIONAL TOLERANCE FOR MOUNTING HOLE - DIA S:  
 [0.25 (0.010) T]  
 5. DIMENSIONING AND TOLERANCING PER ANSI Y14.5, 1982  
 6. NOTCH IS PIN 1 INDICATOR

REPEATABILITY/STABILITY

Repeatability

The maximum difference in the output at any pressure in the operating pressure range when this pressure is applied consecutively under the same conditions and from the same direction.

Stability

The maximum change in output under fixed operating conditions over a specified period of time.

Repeatability refers to a transducer's ability to produce the same output with the same applied pressure while stability is measured after long term cycling or aging (see Figure C). Motorola's long term cycle is defined as 1000 temperature cycles from -40°C to +125°C and  $1.5 \times 10^6$  pressure cycles from zero to 80% of the full scale operating pressure range.

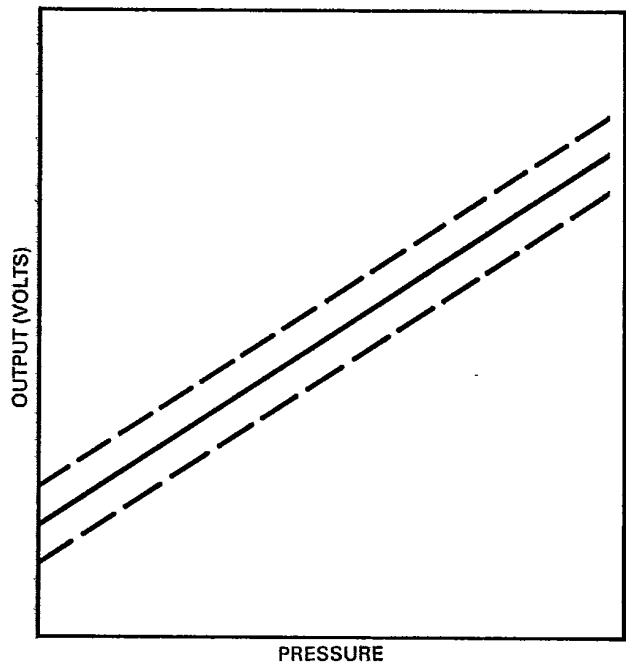

FIGURE C — Repeatability/Stability

Motorola reserves the right to make changes without further notice to any products herein to improve reliability, function or design. Motorola does not assume any liability arising out of the application or use of any product or circuit described herein; neither does it convey any license under its patent rights nor the rights of others. Motorola and  $\text{\AA}$  are registered trademarks of Motorola, Inc. Motorola, Inc. is an Equal Employment Opportunity/Affirmative Action Employer.